

# Bushwick Neighborhood Plan Update



# Acknowledgments

## NYC DEPARTMENT OF CITY PLANNING

Marisa Lago, Director

Anita Laremont, Executive Director

## PROJECT TEAM

Winston Von Engel, Director, Brooklyn Office

Alex Sommer, Deputy Director, Brooklyn Office

Sarit Platkin, Project Manager

Sagi Golan, Senior Urban Designer

Amy Pivak, Planner

Anthony Grande, Planner

Lilia Carrier, Planner

Alexandra Paty Diaz, Urban Designer

## PARTNER NYC AGENCIES

NYC Department of Cultural Affairs

NYC Department of Education

NYC Department of Environmental Protection

NYC Department of Health and Mental Hygiene

NYC Department of Housing Preservation and Development

NYC Department of Parks and Recreation

NYC Department of Small Business Services

NYC Department of Social Services

NYC Department of Transportation

NYC Economic Development Corporation

NYC Housing Authority

NYC Landmarks Preservation Commission

NYC School Construction Authority

NYC Tenant Support Unit

Office of the Deputy Mayor of Housing & Economic Development

# Contents

## Executive Summary

- Preface ..... 1
- Background ..... 2
- Plan Highlights ..... 4
- Neighborhood Context ..... 5

- Neighborhood Snapshot..... 7
  - Population Overview..... 8

- Outreach and Public Process..... 11
  - Timeline..... 14

## Neighborhood Plan Strategies

- Housing..... 17
- Open Space..... 27
- Economic Development..... 33
- Community Health and Resources ..... 39
- Transportation..... 45
- Land Use and Zoning..... 51

- Conclusion and Next Steps ..... 71
  - Timeline and Milestones ..... 72
  - How to get involved..... 73



THE DEAD TRICKS

AVOID THE DRAFT

ONE

COFFEE



# Executive Summary

## Preface

The Bushwick Neighborhood Plan Update aims to promote a long-term vision for the study area that fosters preservation and creation of affordable housing, promotes job growth, identifies neighborhood investments, protects neighborhood character, and channels growth to appropriate locations.

This Bushwick Neighborhood Plan Update is a draft area-wide plan that identifies land use, housing, economic development, transportation, open space, and community health and resource strategies, and builds on previous collaborative work conducted as part of the Bushwick Community Plan (BCP) by the Department of City Planning (DCP), other City agencies, community residents and stakeholders, and non-profit organizations. Council Members Antonio Reynoso and Rafael Espinal, along with Brooklyn Community Board 4, initiated the planning process in 2014 and BCP stakeholders released a final report in September 2018.

## Background

Bushwick is a thriving Brooklyn neighborhood with a diverse community and distinctive culture. The 300-block area lies along the Brooklyn-Queens border, southeast of Williamsburg and northwest of Bedford-Stuyvesant and Ocean Hill, and is home to nearly 121,000 people. Bushwick is a majority-Latino community with many residents from Puerto Rico, the Dominican Republic, Mexico, and Ecuador. The neighborhood has active community-based organizations focused on developing and protecting affordable housing and tenant advocacy. Western Bushwick has active commercial corridors and a large stock of multi-family housing, while Eastern Bushwick is more residential and dominated by owner-occupied two-and-three family rowhouses. The City seeks to create opportunities for new housing and permanently affordable homes in the neighborhood, while protecting the established rowhouse character of many of the side streets. While historically many area residents were predominantly employed in nearby breweries and garment factories, the area now has growing retail, healthcare, service, and arts sectors. Employment in Bushwick increased 37% (4,400 jobs) from 2008-2017, which was nearly double the citywide average during the same period.<sup>1</sup> The neighborhood is also well-served by transit, including the J, M, Z, and L subway lines, and counts more than nine bus routes.



*Recent development*

Bushwick's population has risen steadily since 1980, with a notable increase of 15% (16,000) from 2000 to 2018, which is more than twice the citywide growth rate during the same period.<sup>2</sup> As is true citywide, the population increase in Bushwick is the result of in-migration, but also people living longer and choosing to raise families in the city. This growth is driving an increase in demand for housing in the area and contributing to concerns about neighborhood affordability and resident displacement. 6,600 new housing units have been constructed in Bushwick since 2000, the majority of which have been market rate and not sufficient to meet the demand or affordability needs of existing residents.<sup>3</sup> Bushwick rents rose almost twice as fast (60%) as the borough (38%) and the city (32%) from 2000 to 2016.<sup>4</sup> In addition, more than half of Bushwick households are burdened by high-housing costs, meaning they spend more than 30% of their income on housing (half of these households spend more than 50% of their income on rent). These trends also highlight some of the inadequacies of the area's existing zoning, which remains unchanged since 1961. As Bushwick's existing zoning does not differentiate locations that are appropriate for growth, new development has occurred

<sup>1</sup> Quarterly Census of Employment and Wages (QCEW), 2008 and 2017; DCP HEIP Division (March 2019)

<sup>2</sup> U.S. Census Bureau, 2000, 2010 Censuses; 2018 ACS; DCP Population Division (March 2019)

<sup>3</sup> Certificates of Occupancy for new construction in Community District 4, 2000-2018; NYC Department of Buildings records; DCP HEIP Division (March 2019)

<sup>4</sup> U.S. Census Bureau, American Community Survey, NYU Furman Center

haphazardly, with side-streets and mid-blocks allowing the same height and density as commercial- and transit-corridors. Additionally, there are few zoning incentives and no requirements for permanent affordable housing in new developments and many areas do not allow for new ground floor retail or services.



*Zoning breakout group*

To help New Yorkers stay in their homes and to create new housing to meet increased demand, Mayor de Blasio launched Housing NY in May 2014. This housing plan dramatically increased resources for tenant protections, and is making unprecedented investments to preserve existing affordable housing and construct new affordable housing, including permanent affordable housing through the City's [Mandatory Inclusionary Housing \(MIH\) program](#). Through a public engagement process that began in 2014, multiple City agencies have been working with Bushwick residents and elected officials to advance a neighborhood plan to help identify areas appropriate for new housing as well as for maintaining the existing character.

The Bushwick Neighborhood Plan Update takes a coordinated approach to neighborhood planning through a diverse set of strategies to preserve affordable housing, foster economic opportunity, and implement targeted investments in neighborhood infrastructure and community services in tandem with zoning changes to encourage new housing, especially with affordable housing. With this robust set of strategies, the City seeks to meet the major objectives laid out by the Bushwick Steering Committee in their September 2018 report and encourage Bushwick and its residents to thrive.



*Wilson Avenue*

# Neighborhood Plan Update Highlights

The Bushwick Neighborhood Plan Update seeks to facilitate a thriving and inclusive community by:

- Creating and preserving thousands of homes for lower-income New Yorkers;
- Building a diversified economy with better support for existing businesses and workers, and new jobs and workspace across a variety of sectors;
- Improving and expanding Bushwick’s park and open space network;
- Adding pedestrian safety interventions on key corridors, improving the public realm, and enhancing transit access;
- Ensuring better access to quality health care, education, and arts programming;
- Offering greater protection of historic resources.

## Key strategies include:



- Preserve affordable housing and protect tenants
- Develop new affordable housing
- Make the affordable housing application process easier and more equitable
- Promote local hiring and M/WBE contracting in affordable housing preservation and development projects



- Enhance and expand Bushwick’s neighborhood open spaces
- Build capacity of park stewardship groups



- Expand access to quality public health services and programming in Bushwick
- Create healthier homes in Bushwick to address the neighborhood’s high asthma rates
- Provide resources and support to improve mental health in Bushwick
- Improve access to fresh, healthy, and affordable quality food
- Protect Bushwick’s historic resources through historic preservation tools
- Protect Bushwick’s neighborhood character and scale through contextual zoning
- Ensure that the support of neighborhood-based arts and culture enables existing communities and cultures to thrive in place



- Support businesses and aspiring entrepreneurs, and help them stay and grow in the neighborhood
- Connect Bushwick residents to jobs and job training opportunities



- Preserve neighborhood character of Bushwick’s side streets (i.e. mid-blocks) by establishing contextual zoning districts
- Allow for appropriate growth with permanently affordable housing, retail, and community facilities in appropriate locations on east-west avenues
- Promote higher density mixed-use development with permanently affordable housing close to transit
- Allow building envelope flexibility to respond to elevated train conditions and improve the pedestrian experience along elevated train corridors
- Reinforce and increase job-generating uses and enhance the vitality of industrial districts
- Encourage a mix of residential, commercial, and industrial uses to best respond to needs for both jobs and new housing, including affordable housing



- Enhance pedestrian safety and mobility for Bushwick residents, workers, and visitors
- Promote cohesive streetscapes with quality public spaces, wayfinding, and lighting
- Enhance local transit access, connections, and service



## Neighborhood Context

- The Bushwick Neighborhood Plan study area consists of 300 blocks along the Brooklyn-Queens border, southeast of Williamsburg and northwest of Bedford-Stuyvesant and Ocean Hill;
- It has a population of 121,000 and approximately 16,000 people work in the neighborhood;
- It is well-served by transit, including the J,M,Z and L subway lines and nine bus routes;
- Bushwick counts 14 parks and playgrounds, a major hospital, and three public housing developments.





ONE WAY

P

DELI & GROCERY

Organic Products, Candy, Hot Coffee & Tea, Soda, Tobacco, Snacks, Atm & Ebt

MARTINEZ CLEANER

WE DO ALL KIND OF ALTERATIONS

917-564-6566 EXPERT TAILOR 370 Central Ave

OPEN

# Neighborhood Snapshot

As of 2018, 121,000 people live in Bushwick, representing an upward trend. Bushwick's population has risen steadily since the 1980s, with a notable increase of 15% from 2000-2018, which is more than twice the citywide growth rate. As is true citywide, the population increase in Bushwick is the result of in-migration as well as people living longer and choosing to raise families in the city. The majority of Bushwick's residents are Hispanic or Latinx and 37% of the population is foreign-born. Limited English proficiency is prevalent in Bushwick, and Bushwick residents have lower rates of high school and college graduation than Brooklyn and citywide averages. Educational attainment levels contribute to a high rate of poverty in Bushwick, with 27% of families living below the federal poverty line.

## Bushwick Population

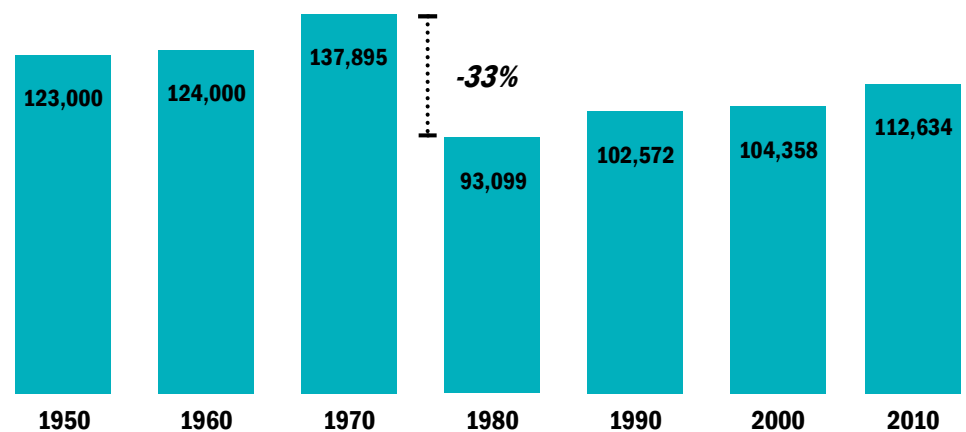

*DCP Population Division, New York City Department of City Planning (July 2011)*

Bushwick's population peaked in 1970, but declined by almost one-third in the following decade. Population has consistently increased since then.

# Neighborhood Snapshot

**2018 Population: 121,000**

**Peak Population: 137,895**

## Bushwick's Changing Population

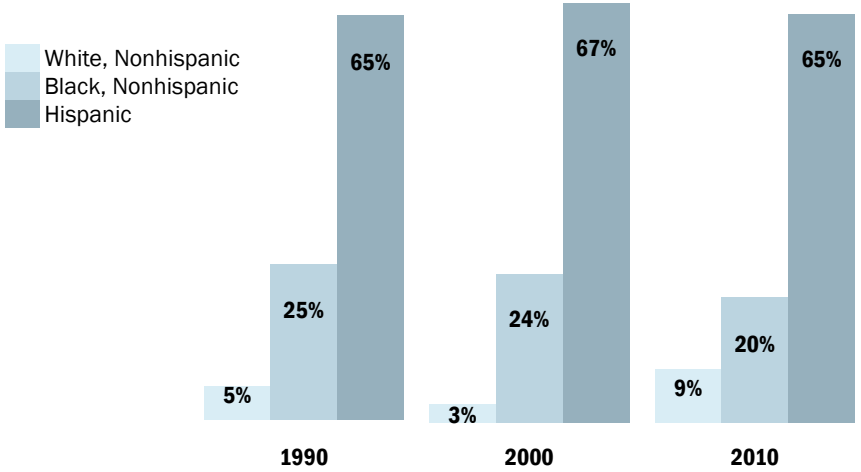

U.S. Census Bureau, 1990, 2000, and 2010 Censuses; DCP Population Division

- **Between 2000 and 2010, Bushwick's White, Nonhispanic population more than doubled (216% growth, 6,538 people).** This was mainly due to in-migration.
- **The Black, Nonhispanic population decreased by 8.7% (2,150 people).** This was dominated by outmigration.
- **The Hispanic population increased 5% (3,474 people).** This was dominated by natural increase (more births than deaths), which outweighed net outmigration. The Hispanic share of the total population in Bushwick decreased during the same period due to population growth.

# 37%

**foreign born population** in Bushwick, which matches the Brooklyn and New York City averages.

ACS 2012-2016

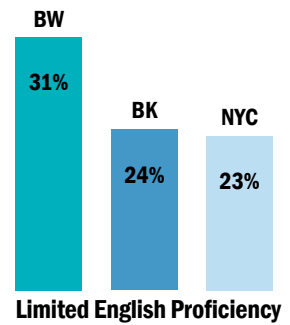

ACS 2011-2015



## Race and Ethnicity

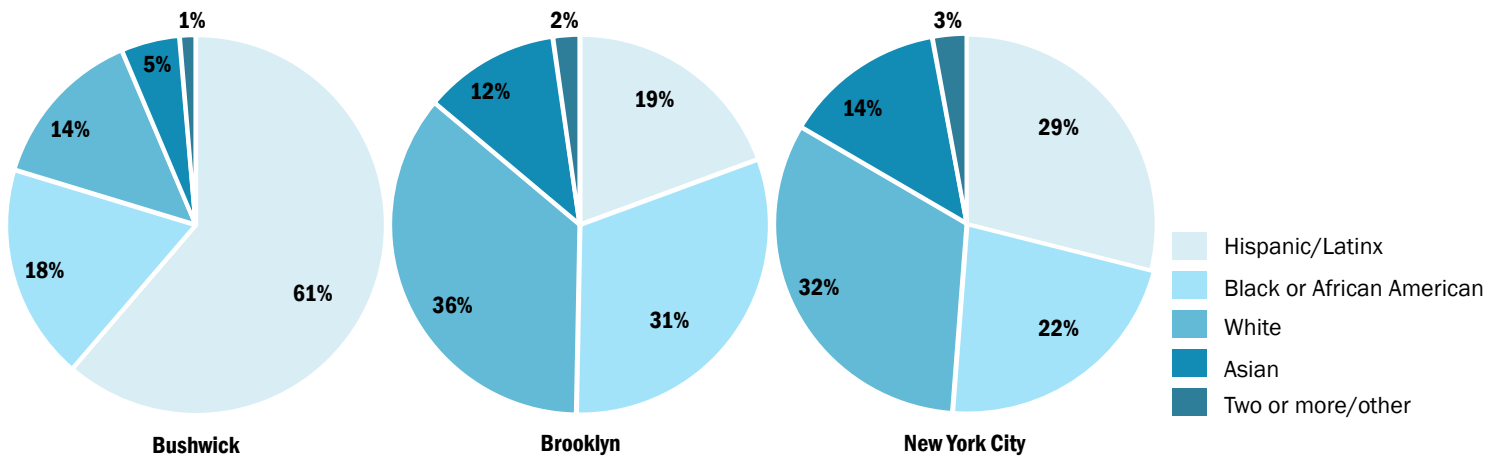

ACS 2012-2016

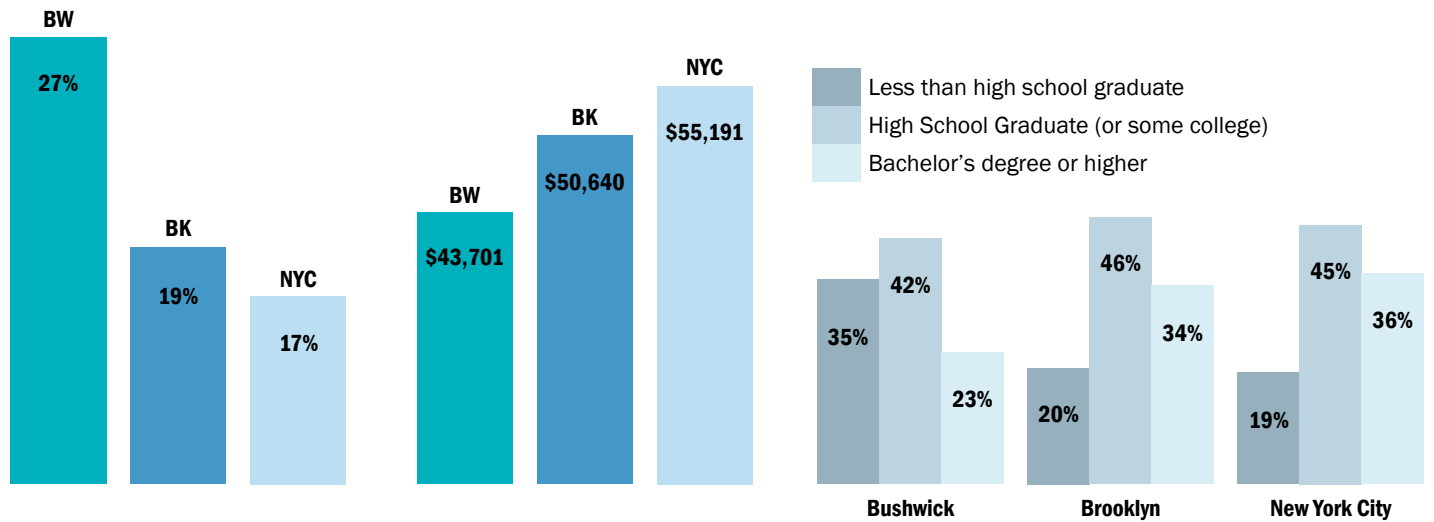

### Families Below Poverty Line

ACS 2012-2016

### Median Household Income

### Educational Attainment



Get back "on-track" in high school

Metropolitan D.P.H.S.  
IS RECRUITING STUDENTS NOW!  
September 2016

FOR MORE INFORMATION:  
THeath3@schools.nyc.gov  
718.342.6249

Metropolitan D.P.H.S.  
3 Blocks East of the Longwood Hospital  
between 106th St. & 107th St.  
Brooklyn, NY 11212

NYC MISSION SOCIETY  
NUNCA es  
Asiados ARDE

**BUSHWICK**  
HOUSING + ZONING / LAND USE  
**SUMMIT**  
**HERE**

**BUSHWICK**  
**CUMBRE**  
VIVIENDA + ZONIFICACIÓN  
**AQUÍ**



Gates Av



# Outreach and Public Process

## Planning Process: 2014-2019

The Bushwick Neighborhood Plan Update builds on a large body of work undertaken by DCP and many other City agencies with community residents, stakeholders, and City Council Members Antonio Reynoso and Rafael Espinal. The collaboration was conducted as part of the Bushwick Community Plan (BCP) process, initiated in 2014 by the Council Members, Community Board 4, and a group of residents and community-based organizations who raised concerns about out-of-character development and tenant displacement, and expressed a need to protect and create affordable housing. This community-led process included the formation of an Executive Committee, a Steering Committee, and specialized Sub-committees focusing on neighborhood-specific topics. Between 2014 and 2018, DCP and other City agencies helped support the BCP, participating in a broad neighborhood process of over 150 meetings, including town halls, community events, and Sub-committee topical meetings.

Major milestones of the planning process since 2014 include:

- In 2014, the planning process began with a diverse set of stakeholders convening for Town Halls to discuss key issues such as out-of-context development and the need for affordable housing;
- A Steering Committee of local stakeholders, including interested residents and representatives from local community groups, was formed in 2014 to oversee and guide the process;
- DCP joined the process at the outset in 2014 to provide technical assistance on land use planning and zoning, and support the Steering Committee in their outreach efforts;



*Planning framework activity*



*Open House, June 2016*

- In 2016, Hester Street Collaborative was selected by the City Council as an outside facilitator for the planning process and relevant City agencies joined the effort as technical advisors;
- In 2016, Sub-committees made up of local residents and stakeholders, Steering Committee and Community Board members, and City agency representatives, formed to gather input and develop recommendations around six focus areas:
  - Housing;
  - Open Space;
  - Economic Development;
  - Community Health and Resources.
  - Transportation and Infrastructure;
  - Land Use and Zoning;
- The Steering Committee and Sub-committees led a robust series of community engagement activities. The City, led by DCP, Council Members Reynoso and Espinal, Hester Street Collaborative, and local organizations jointly planned over 150 public meetings and community events from August 2014 through the release of the BCP in September 2018, including:
  - Monthly Steering Committee meetings;
  - 12 Townhalls/Zoning Workshops/Topic-Specific Meetings;
  - Monthly or twice monthly Sub-committee meetings for 5 Sub-committees;
  - 8 Zoning working sessions;
  - 5 large public events.
- The Sub-committees met regularly, with assistance and coordination by Hester Street Collaborative and DCP, throughout 2016-2017 to develop





*Bushwick Community Plan report*

recommendations, which the Steering Committee voted on in the summer and fall of 2017, and worked to compile into a plan during 2018;

- In September 2018, the BCP Steering Committee released a report to help advance the following goals:
  - Be proactive and intentional about how and where development happens;
  - Create affordable housing;
  - Develop new tools to preserve existing affordable housing;
  - Increase opportunities for small businesses to grow and locate in Bushwick;
  - Work closely with City agencies to direct resources to the community for open space, infrastructure, transportation, and other neighborhood needs.

The Bushwick Neighborhood Plan Update reflects the community outreach conducted during this multi-year planning process and builds on the objectives and strategies put forward in the BCP Steering Committee’s September 2018 report. The BCP and Bushwick Neighborhood Plan Update share a vision for a thriving, inclusive Bushwick and aim to achieve this through a number of overlapping and complementary strategies. While the BCP and Bushwick Neighborhood Plan Update have many shared goals and mutual alignments, they also differ on certain policy objectives. In this document, City agencies worked to prioritize the BCP strategies that could have the greatest lasting impact in the community, as well as advance new strategies to promote shared goals. The City looks forward to ongoing dialogue with community stakeholders as the planning process advances.



*Land Use group at the Housing and Land Use Summit, February 2017*

# Bushwick Timeline

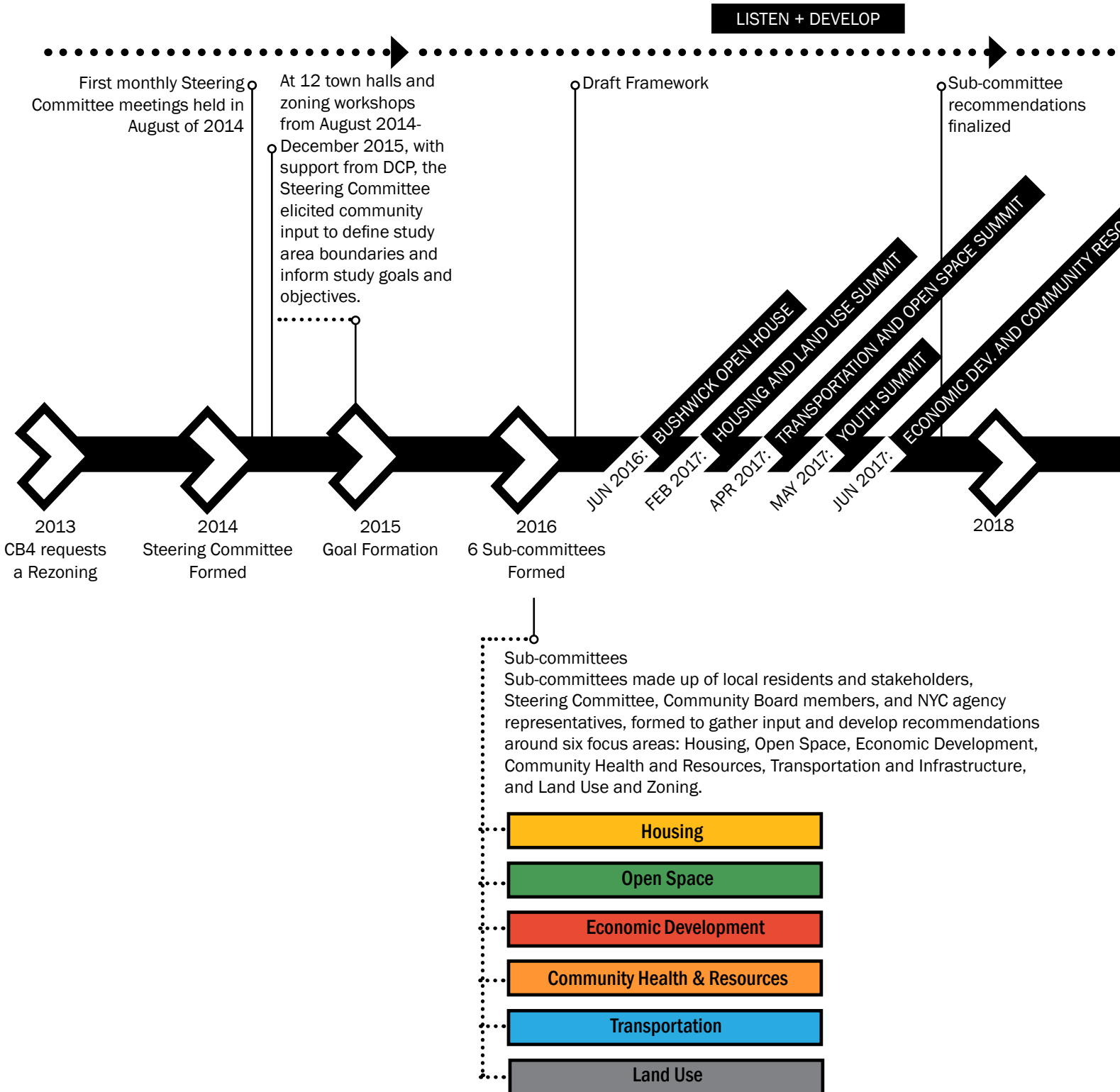

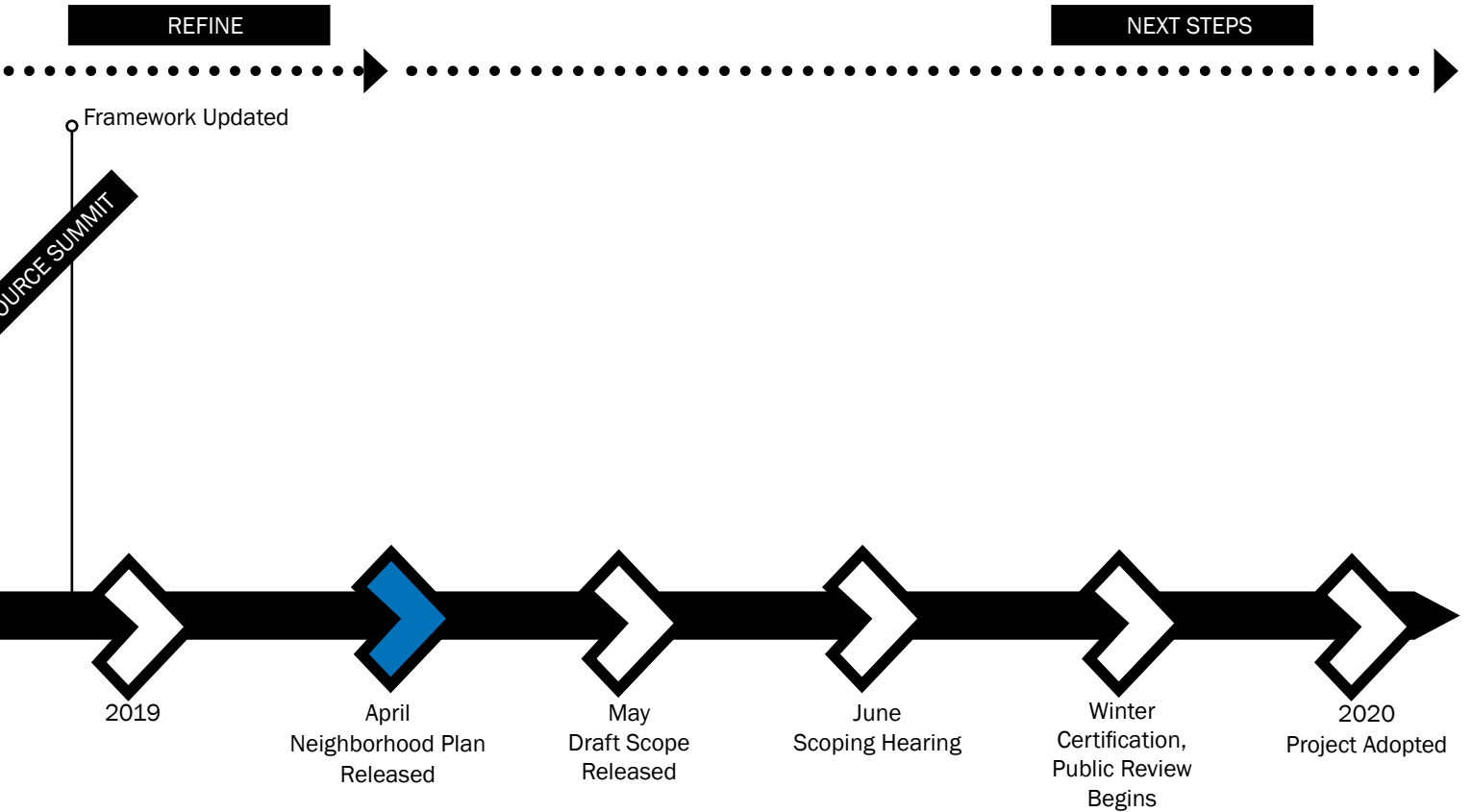

*This timeline reflects the current schedule and is tentative and subject to change*



SCHOOL  
SPEED  
LIMIT  
20  
WHEN  
FLASHING

SCHOOL

LI & BERRY

BY DECKEN BEWITTE

# Housing

Between **2000-2016**  
median rent in Bushwick increased

**60%**

as compared to a **38% increase in Brooklyn** and a **32% increase in New York City** over that same period<sup>1</sup>

## Rent Burden

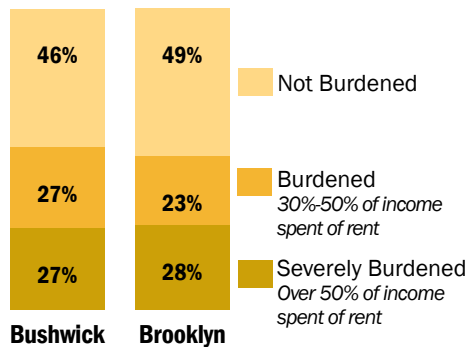

HPD 2014 Housing and Vacancy Survey

Approximate total renter occupied units: 38,000

\*Based on sub-borough boundaries that approximate CD4

As New York City continues to grow, Bushwick residents face a crisis of affordability. Rents increased in Bushwick by 60% between 2000 and 2016, which is almost twice the citywide rate.<sup>1</sup> And over half of Bushwick households are considered “rent burdened,” meaning they spend more than 30% of their income on housing; half of these households spend more than 50% of their income on rent.<sup>2</sup>

In addition to increased costs, many Bushwick residents report that their housing conditions are deteriorating and landlords are engaging in harassing and illegal behavior to try and push them out. These circumstances can force families to make difficult choices about whether to remain in their community or seek better housing opportunities elsewhere.

The existing housing stock in Bushwick presents challenges to protecting tenants and preserving long-term affordability. While 90% of Bushwick residents are renters, over half of the apartments in the neighborhood are in buildings with fewer than six units. As a result, only 26% of households in the neighborhood are living in rent stabilized apartments. The housing stock here is also older than other parts of Brooklyn and the city, with nearly 80% of all buildings built before 1947. This older housing stock has high rates of quality issues, with roughly one out of every six homes experiencing three or more maintenance deficiencies such as inadequate heat or rodent infestation.<sup>3</sup>

To address these issues, the Bushwick Neighborhood Plan Update proposes strategies to stabilize and safeguard Bushwick’s existing affordable housing stock, increase opportunities for new affordable housing development, improve housing quality, and protect tenants from displacement. Taken together, these strategies will work to keep Bushwick residents in their homes and promote a diverse, healthy, and inclusive neighborhood.

1 Approximately 90% of all Bushwick households are renters.

2 New York City Housing and Vacancy Survey (HVS) 2017 Household Record. The HVS is based on 55 Sub-Borough Areas that approximate NYC community districts but are not coterminous.

3 2017 Household Record. The HVS is based on 55 Sub-Borough Areas that approximate NYC community districts but are not coterminous.

## Actions

- Advance development of affordable housing on publicly-owned land:
  - 28 affordable rental homes at 63 Stockholm Street;
  - 24 units of affordable homeownership apartments at Old Stanley;
  - Up to 16 stories of new family and supportive housing at a City owned site at 1531 Broadway;
  - 154 new affordable senior apartments at NYC Housing Authority's (NYCHA) Bushwick II development through the Seniors First initiative.
- Continue to explore additional opportunities for affordable housing on city-owned land;
- Convert 1,315 apartments at Hope Gardens from Section 9 to Section 8 in order to renovate units while preserving their long-term affordability;
- Implement the Certification of No Harassment Pilot Program in Bushwick;
- Host a tenant resource event in the Summer of 2019;
- Continue to support the Urban Homestead Assistance Board (UHAB) and RiseBoro in their Community Land Trust (CLT) proposal.

## Objective: Preserve Affordable Housing and Protect Tenants

### FINANCE AND SAFEGUARD AFFORDABILITY

#### Offer loans and tax incentives to building owners to keep homes affordable

- From 2014 to 2018, the NYC Department of Housing Preservation and Development (HPD) financed the preservation of 1,882 affordable homes in Bushwick.
- HPD will continue monitoring homes in Community District 4 with affordability restrictions in its portfolio, and use its various financing programs to preserve and invest in the neighborhood's existing affordable housing stock.

#### Preserve and reinvest in public housing through the federal Department of Housing and Urban Development's (HUD) Rental Assistance Demonstration (RAD)

- By 2021, the New York City Housing Authority (NYCHA) will convert 1,315 apartments at Hope Gardens from Section 9 public housing subsidy to project-based Section 8 vouchers. This will allow the project to:
  - Raise funds for apartment repairs, infrastructure and underlying building issues;
  - Complete the construction as an in-place rehabilitation so that no residents are displaced; and

#### Housing Tenure

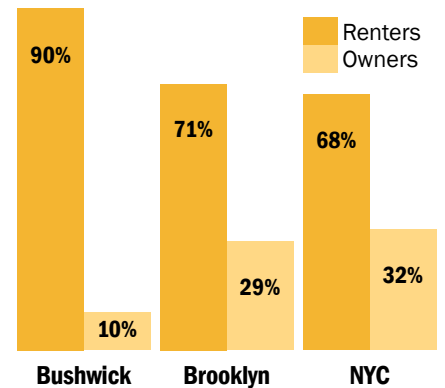

At 10%, Bushwick has much lower rates of homeownership than Brooklyn and citywide.

2012-2016 ACS HPD 2014 Housing and Vacancy Survey.  
Approximate total occupied rental units: 42,000  
\*Based on sub-borough boundaries that approximate CD4

- Maintain the rights that residents have in public housing, including rent set at no more than 30% of adjusted gross income and the right to file grievances.
- NYCHA will consult Hope Gardens residents throughout the conversion process.

**Help community organizations acquire rent-stabilized buildings through HPD's [Neighborhood Pillars Program](#)**

- In 2018, HPD and the NYC Housing Development Corporation (HDC) launched the Neighborhood Pillars Program to finance the acquisition and rehabilitation of existing rent-regulated buildings by non-profits and mission-based organizations.

**Provide technical assistance to property owners through the [Landlord Ambassadors Program](#)**

- Since being selected in 2017, RiseBoro, a local non-profit affordable housing developer, has been working as an HPD "Landlord Ambassador" by conducting outreach and providing technical assistance to owners of multifamily buildings in Bushwick and surrounding areas. Landlord Ambassadors assist property owners by providing information about HPD programs, helping owners navigate HPD program requirements and access other local resources needed in order to close, construct, and operate their properties efficiently and affordably.



*Stockholm Manor has been acquired, refinanced, and will soon be rehabilitated to meet Passive House design standards.*

**Ensure the enforcement of existing agreements between HPD and landlords of affordable housing that guarantee affordable rents, and provide more information to the public**

- Pursuant to new legislation, by April 2019, HPD will submit a report to the City Council providing details of a plan for the development of an integrated data tracking system for the start dates and expiration dates for all of HPD's regulatory agreements containing requirements for affordable housing.

**Incentivize landlords to extend or enter into regulatory agreements by offering energy retrofit grants and loans**

- The Green Housing Preservation Retrofit Program provides low and no interest loans to finance energy efficiency, water conservation, lead remediation, and moderate rehabilitation work. RiseBoro is working with the City to finance green retrofits for two buildings comprising 18 homes in Bushwick.

**Provide funding to support existing and develop new CLT proposals to create new affordable housing**

- In keeping with the Steering Committee's focus on CLTs, HPD is supporting UHAB and RiseBoro in the creation of a CLT to turn 17 existing affordable rental apartment buildings in Bushwick into a scattered site co-op that will provide long-term stewardship and affordability monitoring.

## PROMOTE SAFE AND HEALTHY HOUSING

### Continue to improve housing quality through rigorous enforcement of the Housing Maintenance Code

- HPD works closely with the North Brooklyn Housing Task Force to identify and remediate hazardous housing conditions.
- Between 2015 and 2018, HPD code enforcement conducted more than 37,000 inspections in Bushwick and issued over 50,000 violations.
- Over the same time period, HPD spent over \$3.6 million in emergency repair work to mitigate hazardous conditions like lack of heat or major leaks.

### Support local Bushwick organizations that conduct tenant organizing and education

- HPD and the City Council provide funding to Churches United For Fair Housing (CUFFH) and RiseBoro to support legal counseling, legal representation of tenants, tenant outreach, tenant rights workshops, and referrals that direct tenants to appropriate City agencies.

## PROTECT TENANTS

### Provide free legal representation to Bushwick tenants facing harassment

- Since October 2015, City-funded legal services providers have served approximately 4,100 households in the Bushwick zip codes of 11221, 11206 and 11237, providing legal assistance, advice, and representation to approximately 11,000 Bushwick residents in need.

### Educate tenants about their rights and resources to prevent displacement

- The Tenant Support Unit (TSU), part of the Mayor's Public Engagement Unit, has been conducting proactive outreach in Bushwick since January 2017, to tenants who may be at risk of displacement or are experiencing landlord harassment. Outreach specialists go door-to-door to inform them of their rights, identify housing-related issues and connect them to free City services, such as legal assistance, to keep them stably housed in their community. Through door-knocking, office hours, and events with local community-based organizations and elected officials, TSU has conducted targeted outreach to over 8,700 households in Bushwick through February 2019.

### Establish a Certification of No Harassment (CONH) Pilot Program

- As a result of BCP Steering Committee input, the City launched a CONH Pilot Program in Bushwick in September 2018. It requires owners of covered buildings to obtain a certificate from HPD proving that they have not harassed tenants before they can work in or demolish rent stabilized buildings.

# 4,100

**Bushwick households have received City-funded legal services since 2015.**

*NYC Department of Social Services*



*HPD Inspectors*

# 8,700

**households in Bushwick have been reached through the Tenant Support Unit.**

*NYC Department of Social Services*



- When a building owner subject to the program applies for a CONH, building tenants, community groups, the Community Board, and elected officials will be notified.

**Investigate construction and maintenance harassment through HPD’s newly created Tenant Anti-Harassment Unit**

- Announced in 2018, HPD’s new Tenant Anti-Harassment Unit will use data analysis to identify potential buildings where harassment is occurring, respond to emergency complaints, partner closely with the Department of Buildings and other agencies to address issues in buildings where maintenance harassment has been identified, and connect tenants with legal services.

**Objective: Make the affordable housing application process easier and more equitable**

**Refine marketing guidelines to reach New Yorkers most in need**

- In response to ongoing advocacy by community partners, HPD updated the affordable housing [Marketing Handbook](#) to make the process of applying for housing more equitable and efficient, and to ensure that new units will serve the New Yorkers that need them most. These policy changes include:
  - Significantly limiting options to reject applicants based on credit history and debt or their history in Housing Court;
  - Clarifying eligibility guidelines for a speedier review process by eliminating the mandatory employment history requirement for self-employment and freelance income; and
  - Introducing additional protections for victims of domestic violence.

**Make it easier for residents to understand, prepare for, and complete the affordable housing application process**

- HPD’s Housing Ambassadors Program trains local community groups to provide free technical assistance to residents who wish to apply for affordable housing. Churches United for Fair Housing is HPD’s Housing Ambassador for Bushwick.

**Objective: Promote local hiring and Minority and Women-Owned Business Enterprise (M/WBE) contracting in affordable housing projects**

**Expand local hiring incentives in HPD-financed developments**

- The HireNYC program requires that any housing development receiving \$2 million or more in HPD subsidy post open positions with the Workforce1 system and consider qualified candidate.

- In all future request for proposals (RFPs) for the development of City-owned property, respondents must demonstrate a plan for outreach to Bushwick residents related to employment opportunities generated by the project.

**Build the capacity of M/WBE and nonprofit developers through professional development, networking, and mentoring programs, and expand opportunities for M/WBE construction contractors and professional service providers.**

- The Building Capacity Workshop Series introduces M/WBE and non-profit developers to best practices in affordable housing development, from site selection and project financing to construction and property management.
- The M/WBE Build Up Program requires developers of projects where HPD contributes \$2 million or more in subsidy to spend at least a quarter of all HPD supported costs on certified M/WBE construction or design firms.

## Objective: Develop New Affordable Housing

**Partner with community-based organizations to redevelop underbuilt city-owned sites as 100% affordable housing with zoning that maximizes affordability and a diverse mix of housing types and income levels**

- HPD will partner with RiseBoro and St. Nicks Alliance on “Bushwick Alliance,” to build 28 affordable apartments – 20 at 63 Stockholm Street, and 4 each at 332 Eldert Street and 272 Jefferson Street, through its Neighborhood Construction Program. The project will serve a range of incomes from 30-80% of Area Median Income.
- In “Old Stanley,” HPD will partner with Riseboro to build 24 affordable units total in three buildings, all of which will provide affordable home-ownership opportunities for those making 80-120% AMI, through HPD’s New Infill Homeownership Opportunities Program (NIHOP).
- HPD has awarded a vacant site at 1531 Broadway, located at the intersection of Broadway and Hancock Streets, to RiseBoro for the development of approximately 125 affordable family and supportive housing units for the formerly homeless and individuals with disabilities.
  - As part of the Bushwick rezoning, 1531 Broadway, located at the intersection of Broadway and Hancock streets abutting the J and Z elevated train line, will be rezoned to a contextual C4-4D district (R8A equivalent). See p.63 for more information on C4-4D.
  - The new zoning will allow up to 16 stories and maximize the number of affordable housing units that can be constructed at this transit-rich location. The site will be financed through HPD’s Supportive Housing Loan Program.



**OLD STANLEY**

641 Chauncey Street

DEVELOPER: RiseBoro

HPD PROGRAM: HPD Open Door

*RiseBoro will construct 16 cooperative units of affordable home-ownership apartments for low-moderate income homeowners on vacant land next to Riseboro’s Moffat Gardens senior housing project.*



**OUR LADY OF LOURDES APARTMENTS**

1875 Broadway and 11 & 21 De Sales Place

DEVELOPER: RiseBoro

HPD PROGRAM: Extremely Low & Low-Income Affordability (ELLA)

*Two new construction buildings and one rehab of a former rectory resulting in 76 units. All units are affordable to families making 80% of AMI and below.*

**Affordable Apartments Financed in Bushwick**

Since 2003, HPD has financed the construction and preservation of 3,376 affordable homes. The Bushwick Neighborhood Plan includes a set of strategies designed to accelerate and increase the new construction and preservation of affordable housing in the years to come.

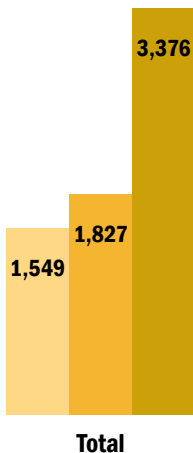
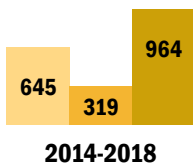
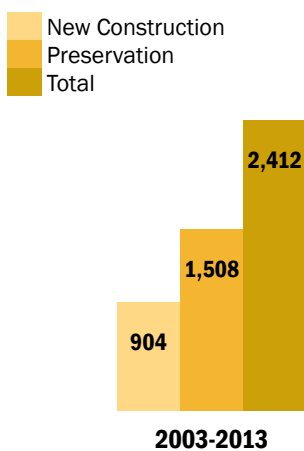

- As part of the Housing 2.0 [Seniors First initiative](#), Blue Sea Development Company and Gilbane Development will build Linden Court, a 13-story building comprised of 154 senior apartments at NYCHA's Bushwick II (Group E) development in Brooklyn. See additional information on p.25.

**Continue to explore additional opportunities for affordable housing on City-owned land**

- Evaluate additional publicly owned sites that are currently in use by City agencies, but may be appropriate for redevelopment with affordable housing. While many of these properties serve critical community functions, HPD is actively working with its partner agencies to evaluate whether they can be relocated and/or incorporated into new affordable housing development on-site.

**Mandate affordable housing as part of new development in rezoned areas**

- Through the Mandatory Inclusionary Housing (MIH) program, the City will require new residential buildings along Broadway and Myrtle, Wyckoff, and Knickerbocker avenues to create permanently affordable housing.
- MIH requires private developers to set aside 20-30% of units in all new buildings as permanently affordable housing whenever land is rezoned for increased or new residential units.
- New affordable apartments will offer significantly lower rents than market-rate units in Bushwick.

**Offer financing to incentivize the development of affordable housing that exceeds minimum MIH requirements**

- In response to community feedback, HPD recently updated the terms of its financing programs. The agency now requires a 10% set aside for homeless families and individuals in nearly every project, and more homes for extremely low- and very low-income households.
- Any project in an MIH area receiving City subsidy must also now set aside an additional 15% of apartments as permanently affordable, on top of the baseline MIH requirements of 20-30%, which would result in 35-45% of all new apartments being permanently affordable.

# Mandatory Inclusionary Housing Options

During the public review process, the City Council and the City Planning Commission (CPC) can choose to impose one or both of two basic options to apply to a rezoning:

**25% Affordable Units**  
75% Market Rate

MIH Option 1: 25% of housing must serve households with incomes averaging to \$56,000 (60% Area Median Income (AMI))  
At least 10% of which must be at or below \$38,000 (40% AMI)

Examples:

| # of Units <sup>11</sup> | AMI              | Maximum Annual Income <sup>10</sup> | Sample Rent <sup>10</sup> |
|--------------------------|------------------|-------------------------------------|---------------------------|
| 10                       | 40% <sup>9</sup> | \$37,560                            | \$810                     |
| 5                        | 60% <sup>9</sup> | \$56,340                            | \$1,280                   |
| 10                       | 80% <sup>9</sup> | \$75,120                            | \$1,820                   |

| # of Units | AMI              | Maximum Annual Income <sup>10</sup> | Sample Rent <sup>10</sup> |
|------------|------------------|-------------------------------------|---------------------------|
| 10         | 40% <sup>9</sup> | \$37,560                            | \$810                     |
| 7          | 60% <sup>9</sup> | \$56,340                            | \$1,280                   |
| 8          | 80% <sup>9</sup> | \$75,120                            | \$1,820                   |

**30% Affordable Units**  
70% Market Rate

MIH Option 2: 30% of housing must serve households with incomes averaging to \$75,000 (80% AMI)

Examples:

| # of Units <sup>11</sup> | AMI               | Maximum Annual Income <sup>10</sup> | Sample Rent <sup>10</sup> |
|--------------------------|-------------------|-------------------------------------|---------------------------|
| 10                       | 30% <sup>9</sup>  | \$28,170                            | \$575                     |
| 10                       | 80% <sup>9</sup>  | \$75,120                            | \$1,820                   |
| 10                       | 130% <sup>9</sup> | \$122,070                           | \$2,993                   |

| # of Units | AMI               | Maximum Annual Income <sup>10</sup> | Sample Rent <sup>10</sup> |
|------------|-------------------|-------------------------------------|---------------------------|
| 10         | 60% <sup>9</sup>  | \$56,340                            | \$1,280                   |
| 10         | 80% <sup>9</sup>  | \$75,120                            | \$1,820                   |
| 10         | 100% <sup>9</sup> | \$93,900                            | \$2,289                   |

In addition to the two basic options, City Council and CPC may add this additional option:

**20% Affordable Units**  
80% Market Rate

MIH Option 3: 20% of housing must serve households with incomes averaging to \$38,000 (40% AMI)

Subsidy is allowed only if more affordable housing, beyond the MIH minimum, is provided.

Examples:

| # of Units <sup>11</sup> | AMI              | Maximum Annual Income <sup>10</sup> | Sample Rent <sup>10</sup> |
|--------------------------|------------------|-------------------------------------|---------------------------|
| 5                        | 30% <sup>9</sup> | \$28,170                            | \$575                     |
| 10                       | 40% <sup>9</sup> | \$37,560                            | \$810                     |
| 5                        | 50% <sup>9</sup> | \$46,950                            | \$1,045                   |

| # of Units | AMI              | Maximum Annual Income <sup>10</sup> | Sample Rent <sup>10</sup> |
|------------|------------------|-------------------------------------|---------------------------|
| 16         | 30% <sup>9</sup> | \$28,170                            | \$575                     |
| 4          | 80% <sup>9</sup> | \$75,120                            | \$1,820                   |

<sup>9</sup> Developers can provide a range of low to moderate income tiers, if rents of the affordable units achieve the required average AMI.  
<sup>10</sup> Rents and incomes are examples based on a three-person household, and two-bedroom sample rents and 2018 HUD Income Limits.  
<sup>11</sup> Sample unit distribution is based on a 100-unit building.

### **FEATURED PROJECT: Linden Court, Seniors First Initiative**

As part of the Housing 2.0 Seniors First initiative, Blue Sea Development Company and Gilbane Development will build Linden Court, a 13-story building comprised of 154 senior apartments at NYCHA's Bushwick II (Group E) development. Built to Passive House standards using innovative pre-fabricated modular construction, the new building will include an approximately 3,000 square foot senior center with an art gallery and café, warming kitchen, bathrooms, and two large multi-program rooms that can be divided to accommodate small classes and events. Senior social services will be run by Jewish Association Serving the Aging with additional programming provided by Brooklyn Arts Council. Linden Court will serve residents age 62 years and older with incomes capped at 50% of AMI. One quarter of the apartments will be set aside for NYCHA residents and 30 percent will be set aside for formerly homeless residents. NYCHA will maintain ownership of the land, ensuring long-term affordability.





# Open Space

# 14

community parks and playgrounds in Bushwick

# 1

new park under construction

Bushwick is home to fourteen community parks and playgrounds containing play equipment, sports courts, athletic fields, grassy open areas, and other park amenities. The neighborhood is anchored by Maria Hernandez Park in the west and Irving Square Park in the east, both offering passive and active recreation, play equipment, areas for relaxation, and trees for shade. Bushwick is also dotted with playgrounds and community gardens. There are several park reconstruction projects in progress that will expand Bushwick's array of open space facilities. A new comfort station is under construction at Green Central Knoll, and Hope Ballfield is undergoing a full reconstruction to upgrade the ballfield, seating area, playground and adult fitness equipment. Additionally, the New York City Department of Parks and Recreation (NYC Parks) is constructing a new half-acre open space, Beaver Noll Park, which will include a play area, seating, and greenery. Work is underway to provide Rudd Playground with a new skate park and basketball courts, and to provide a new synthetic turf and an adult fitness area at Maria Hernandez Park.

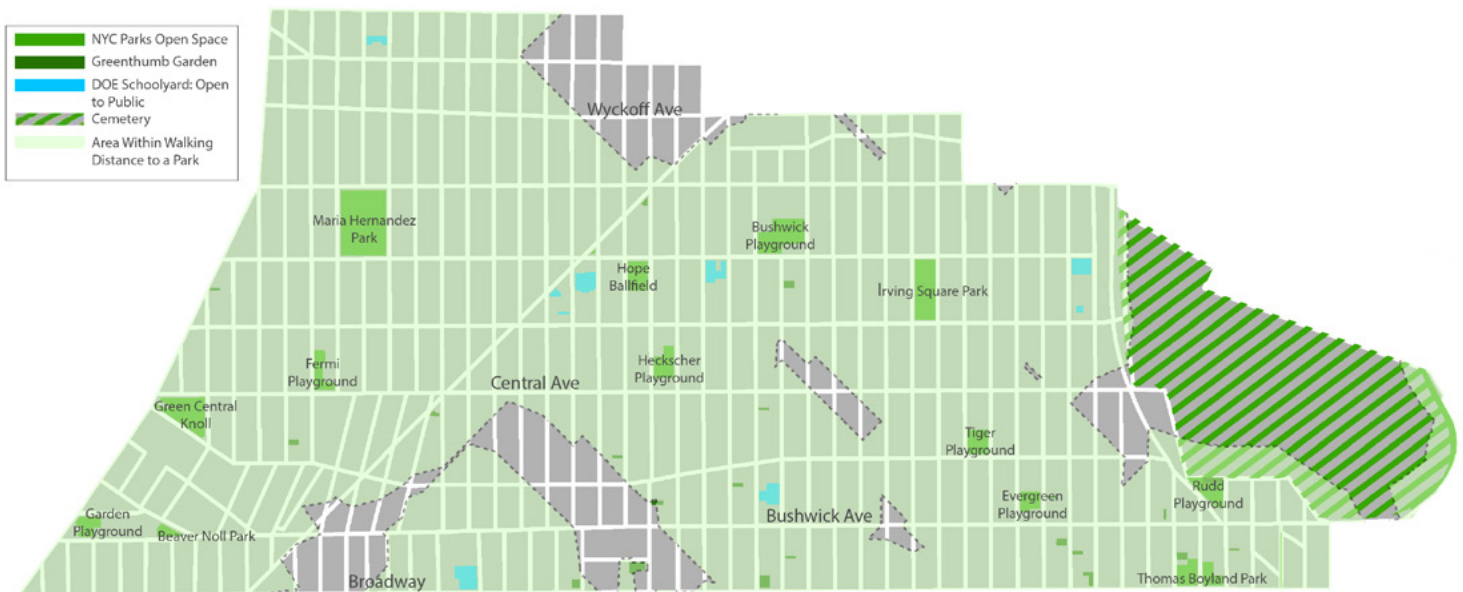

## Actions

NYC Parks is working on several capital projects to provide new amenities in Community Board 4, an investment of over \$10 million.

### Hope Ballfield Reconstruction

This project will include the construction of a new natural turf baseball field, as well as new adult fitness equipment, play equipment, sitting and picnic areas, and perimeter sidewalks. The project is in construction and expected to be completed in 2019.

### Green Central Knoll Comfort Station Construction

NYC Parks is constructing a new comfort station and accessible ramp in Green Central Knoll. The comfort station is under construction and is expected to be completed in 2019.

### Maria Hernandez Synthetic Turf Field Construction

NYC Parks will construct a new synthetic turf field and fitness area in the northeastern portion of Maria Hernandez Park. NYC Parks is procuring a contractor and, pending successful procurement, expects to break ground in 2020.

### Rudd Playground Skate Park and Basketball Courts Reconstruction

NYC Parks will construct a new skate park with a seating area, and a new accessible ramp to connect the two levels within the park. NYC Parks will also reconstruct the basketball courts, stairs, and fencing; and upgrade the benches, planting, drainage, water supply systems, and park security lighting. NYC Parks is procuring a contractor and, pending successful procurement, expects to break ground in 2019.

## Objective: Enhance and expand Bushwick's neighborhood open spaces

### Provide new recreational amenities in Bushwick's parks

- Bushwick contains an array of recreational amenities, yet there is still a demand for additional recreational opportunities to serve people of all ages. In Bushwick, NYC Parks is constructing new facilities in Rudd Playground, Maria Hernandez Park, Hope Ballfield, and Green Central Knoll.

### Expand Bushwick's open space network

- The majority of Bushwick's residents live within a walk to a park; however, Bushwick has a lower open space ratio than the citywide average. NYC Parks is exploring multiple approaches to improve park access and expand park acreage, ranging from developing new parks to forming partnerships, such as

# 88%

**of Bushwick residents live within walking distance of a park or open space, just above the citywide goal of 85%.**

*New York City Department of Parks & Recreation, OneNYC*



*Proposed Green Central Knoll Comfort Station*

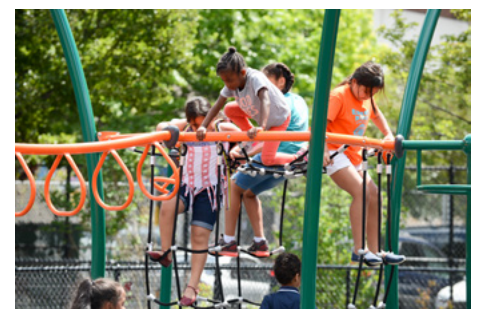

*Heckscher Playground*



**BUSHWICK  
OPEN SPACE  
AMENITIES:**

**19**  
basketball courts

**18**  
handball courts

**2**  
soccer fields

**4**  
baseball and softball fields

**2**  
running tracks

**10**  
spray showers

**6**  
restrooms

potential partnerships with the Department of Education or NYCHA, to secure additional publicly accessible open space.

- Bushwick’s newest park, Beaver Noll Park, is currently under construction. The new park will feature new play equipment and a spacious seating area with trees and greenery. Additionally, Bushwick residents will soon enjoy increased open space with the opening of PS 377’s schoolyard to the public. The schoolyard will be reconstructed by the New York State Office of Parks, Recreation and Historic Preservation in partnership with the Trust for Public Land, through New York State’s Vital Brooklyn initiative. This newly accessible open space will serve Bushwick residents who currently live outside of a walk to a park.

**Activate Bushwick parks with public programming**

- NYC Parks recognizes that people make our parks and is dedicated to creating vibrant, active community spaces with a variety of public programming options. Among the many public programs available to New Yorkers, community members can request that [Mobile Recreation Vans](#) visit their community parks to provide free play and fitness programming. NYC Parks also works to bring free, drop-in fitness classes through the [Shape Up program](#). With Shape Up, NYC Parks partners with local organizations to secure all-weather spaces for fitness programming to provide a fun outlet for New Yorkers to stay active.

**Objective: Build capacity of park stewardship groups**

**Support and cultivate dedicated park partners with Partnerships for Parks**

- NYC Parks works in tandem with [Partnerships for Parks](#) to cultivate community partners dedicated to the advocacy and stewardship of their local parks. By hosting trainings and workshops, outreach coordinators assist park partners who want to expand their group membership, host an event or stewardship activity, or fundraise. [Partnerships for Parks also provides grants](#) to help park “friends” groups fund their park projects.
- Bushwick has a strong community-led “friends” network, which is pivotal to the programming and stewardship of the community’s parks. Partnerships for Parks works with community groups and others to host It’s My Park stewardship events, and will provide tools and support needed to organize the event.

## FEATURED PROJECT: BEAVER NOLL PARK CONSTRUCTION

NYC Parks is constructing a new open space, Beaver Noll Park, at the intersection of Bushwick Avenue and Beaver Street. This project will add approximately half an acre of new open space and will feature a new seating area, play equipment, and greenery. The project is in construction and will be completed in 2019.



Schematic design for Beaver Noll Park, a new park on Beaver Street and Bushwick Avenue.

## **FEATURED PROJECT: THOMAS BOYLAND PARK RECONSTRUCTION**

NYC Parks recently completed a \$4.5 million reconstruction of Thomas Boyland Park, located on Broadway between Granite and Aberdeen streets. The project was completed through the Community Parks Initiative, a mayoral program to re-imagine local parks in dense and growing neighborhoods that have not seen significant capital investment in a over twenty years. The upgraded park now includes water play, adult fitness equipment, a seating area, basketball and handball courts, and a ballfield.





WALKER  
WALKER



# Economic Development

**96%** of Bushwick residents (40,662) work outside of the neighborhood.

In 2018, top employment destinations for Bushwick residents included the traditional NYC job hubs of Midtown Manhattan, the Financial District, and Downtown Brooklyn.

**Bushwick Resident Employment by Sector**

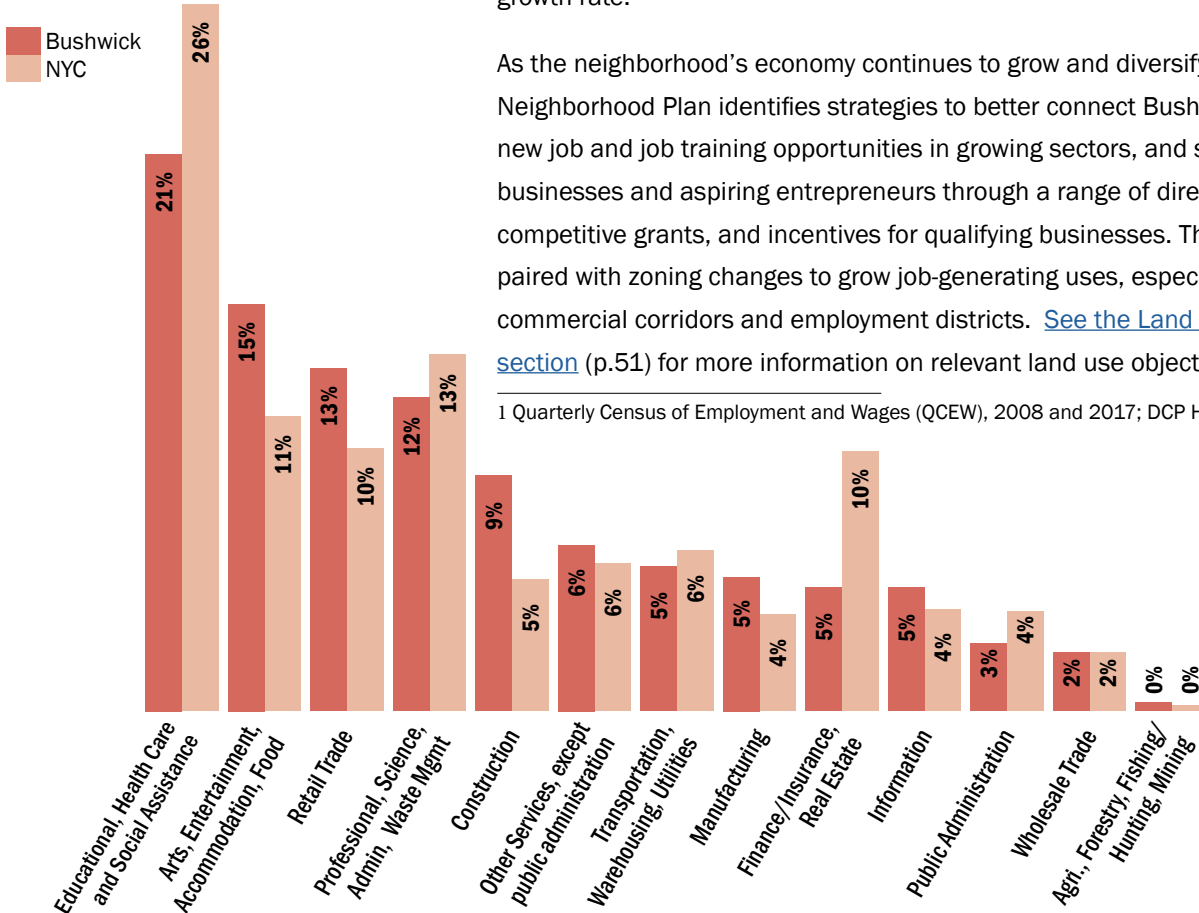

Increasing economic opportunity and access to quality jobs are central to the long-term vision for the Bushwick neighborhood. While historically, the neighborhood’s breweries, garment factories, and other industrial uses along Flushing Avenue and the eastern edges of the neighborhood served as important sources of entry-level, middle-wage, and career jobs, shifting economic patterns and changes in technology have led to a steady decline in industrial employment in Bushwick. Today, more than 60 percent of Bushwick’s residents work in service sectors that are growing city-wide, such as education, health care, social services, arts and entertainment, and retail. Economic growth within Bushwick has similarly been dominated by these sectors, with the greatest gains being in retail, entertainment, food service, and hotels from 2008-2017 (+105% or 1,971 jobs). In total, Bushwick added 4,400 jobs during the same period, a 37% increase, which was nearly double the citywide growth rate.<sup>1</sup>

As the neighborhood’s economy continues to grow and diversify, the Bushwick Neighborhood Plan identifies strategies to better connect Bushwick residents to new job and job training opportunities in growing sectors, and support Bushwick businesses and aspiring entrepreneurs through a range of direct services, competitive grants, and incentives for qualifying businesses. These strategies are paired with zoning changes to grow job-generating uses, especially along Bushwick’s commercial corridors and employment districts. [See the Land Use and Zoning section](#) (p.51) for more information on relevant land use objectives.

<sup>1</sup> Quarterly Census of Employment and Wages (QCEW), 2008 and 2017; DCP HEIP Division (March 2019)

US Census Bureau, American Community Survey; Population Division New York City Department of City Planning (U.S. Census Bureau 2016 American Community Survey)

## Actions

- In partnership with local community-based organizations, SBS is ready to deploy the mobile outreach unit in Bushwick in spring 2019. The mobile outreach unit is a resource that serves job seekers and small businesses directly in their neighborhood. It is equipped with classroom space and computers and can be used to provide SBS services, such as connections to free business services, one-on-one technical assistance with M/WBE Certification applications, and recruitment events to connect jobseekers with employment opportunities.
- To ensure that Bushwick businesses are aware of SBS's free services, SBS will deploy its Chamber On-the-Go outreach team in spring 2019. Through Chamber On-the-Go, SBS deploys trained business specialists to connect with small business owners directly in their neighborhoods, assess their needs, and connect them with relevant SBS services, such as the Commercial Lease Assistance Program.
- SBS has a Neighborhood 360° Fellowship program designed to help community-based organizations complete commercial revitalization projects and connect local stakeholders to City resources. In 2018, RiseBoro Community Partnership was selected to host a Neighborhood 360° fellow to serve Bushwick small businesses. Bushwick nonprofit community-based organizations, such as Business Improvement Districts, local development corporations, and merchants associations, are encouraged to host a fellow by applying to be a host site. Host site [applications for the 2020-2021 Fellowship cohort will open in fall 2019](#).
- NYCEDC will work with local partners on a comprehensive plan for marketing tax incentive programs to Bushwick residents and businesses to help them grow.
- NYCEDC will work with local partners to connect Bushwick residents to internship and other opportunities in growing sectors, such as tech and life sciences, through initiatives like [LifeSciNYC](#) and [CyberNYC](#). NYCEDC will also market opportunities for Bushwick residents to access workshop and incubator spaces at [Futureworks](#) and [Makerspace](#) at Brooklyn Army Terminal.
- In May 2019, NYCEDC will announce a new Community Partner at Moore Street Market to strengthen engagement with local residents through free programs and events, including the operation of a newly-built demonstration kitchen which will open in Summer 2019 for cooking classes and culinary programming.
- In spring 2019, Bushwick stakeholders will be able to explore strategies to connect Bushwick residents to job training opportunities with DCP, the Mayor's Office of Workforce Development, and other workforce partners.



*The SBS Mobile Outreach Unit*



*N360 Fellow at a Riseboro community cleanup event on Knickerbocker Avenue in November 2018.*

Between 2008-2017  
the number of jobs in  
Bushwick increased by **37%**  
or 4,400 jobs.

Quarterly Census of Employment and Wages (QCEW),  
2008 and 2016 (3Q); DCP HEIP Division (March 2017;  
updated July 2018)



*Bushwick Commercial District Needs Assessment*

**16,300**  
total Bushwick jobs in 2017

## Objective: Support businesses and aspiring entrepreneurs, and help them stay and grow in the neighborhood

### Help Bushwick businesses grow

- NYC Small Business Services (SBS) provides free help to Bushwick business owners and entrepreneurs to kickstart, operate, and grow their business through business courses, financing assistance, incentives, help navigating government, recruitment, and support with M/WBE Certification. These services can be discussed in-person at one of seven [Business Solutions Centers](#) in the city. Bushwick business owners can visit the Brooklyn Business Solutions Center at 9 Bond Street in Downtown Brooklyn.

### Provide small business legal support

- Through the [Commercial Lease Assistance \(CLA\) Program](#), SBS can provide small business owners in Bushwick with free legal assistance on topics that include new leases, lease renewals, back rent negotiations, landlord harassment and breaches of contract, and lack of landlord repairs.

### Strengthen Bushwick's commercial corridors

- To help strengthen and support the businesses on Bushwick's commercial corridors, SBS has a [variety of competitive grants](#) available for local non-profits, Business Improvement Districts (BIDs), and other community-based development organizations to undertake commercial revitalization and economic development projects in their neighborhood. The City has already awarded \$40,000 to RiseBoro and Brooklyn Alliance within the last two years to conduct a [Commercial District Needs Assessment \(CDNA\)](#) and support merchant organizing efforts in Bushwick.

### Promote space opportunities and business trainings to local Bushwick entrepreneurs

- Through educational opportunities, incubators, accelerators, and shared industry workspace, NYCEDC can support and grow targeted industries to create good paying jobs for Bushwick residents. NYCEDC will connect Bushwick entrepreneurs with leasing opportunities at Moore Street Market, incubator spaces at Brooklyn Army Terminal, and internship opportunities in tech and life sciences.

### Promote tax incentives that are available to local businesses to help them grow

- To diversify and strengthen Bushwick's economy, NYCEDC supports businesses, developers, and nonprofit organizations looking to undertake real estate projects and grow their operations. Through the use of tax incentives, bond financing, and a portfolio of investment funds, NYCEDC provides Bushwick businesses financing opportunities to foster growth across a variety of sectors, including: industrial; technology; bioscience; nonprofit; infrastructure and energy; and certain commercial and retail activities. See a case study on p.37.

# Objective: Connect Bushwick residents to jobs and job training opportunities

## Connect residents to training opportunities

- SBS runs a network of 18 [Workforce1 Centers](#) across the city that connect Bushwick jobseekers to employment and training opportunities and offer Bushwick businesses free recruitment. Two of the closest Workforce1 Career Centers to Bushwick are located at 2619 Atlantic Avenue in East New York and 9 Bond Street in Downtown Brooklyn, across from Albee Square along the Fulton Mall.

## Provide on-the-job training

- SBS provides Bushwick small businesses with opportunities to strengthen their workforce through its [“On-the-Job Training”](#) and [“Customized Training”](#) programs. On-the-Job Training provides business owners with a grant covering up to 70% of the cost of training and onboarding new employees. Customized Training is a grant that provides up to \$400,000 to small business owners to invest in their employees through new training.

## Develop tailored job training opportunities

- By engaging relevant stakeholders through the [Industry Partnerships initiative](#), SBS is able to identify gaps in the labor market and develop new job training models that can be replicated by providers throughout the city. SBS Industry Partnerships have been launched in tech, healthcare, manufacturing, food and beverage, and construction, sectors growing in Bushwick and citywide. Bushwick stakeholders will be able to explore opportunities and strategies to connect Bushwick residents to these fields in partnership with DCP, the Mayor’s Office of Workforce Development, and other workforce partners in spring of 2019.

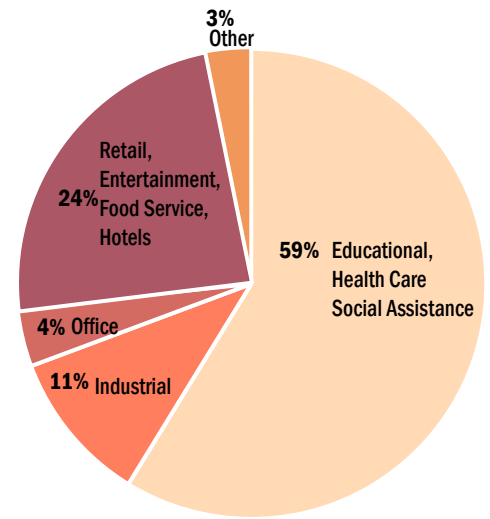

**Jobs in Bushwick by sector (out of 16,300 total jobs)**

## Change in Employment in Bushwick (2000-2017)

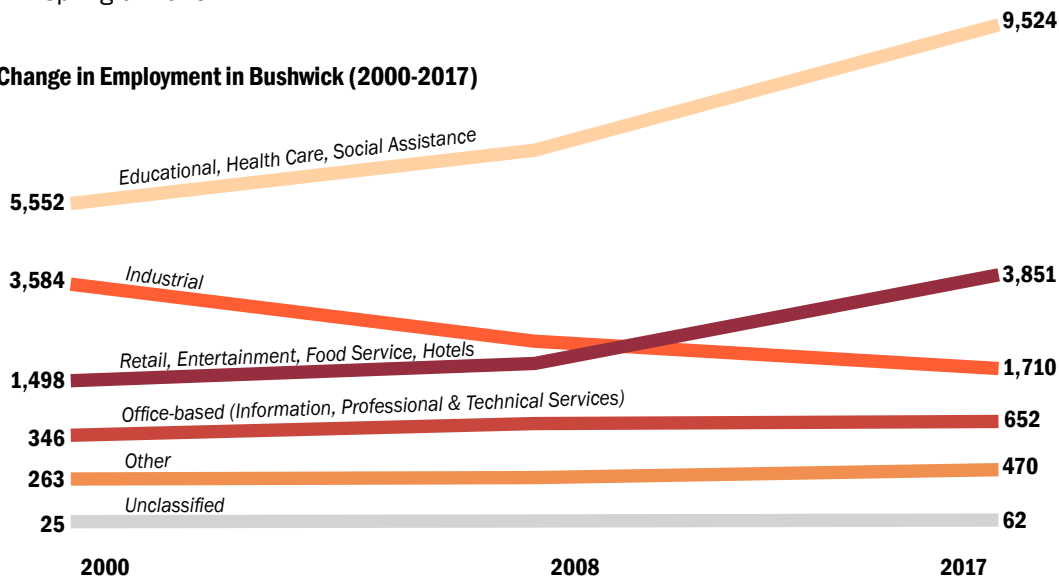

NYS Department of Labor, Quarterly Census of Employment and Wages (QCEW); 2000, 2008, and 2017 (Q3). NYC Department of City Planning, HEIP Division. March 2019. Note: macro sectors represent aggregations of U.S. BLS NAICS 2-digit industry sector employment data that generally reflect land use patterns associated with certain kinds of professions.





*Proposed renovation of 105 Evergreen  
Credit: UOVO*

### **FEATURED PROJECT:**

#### **Uovo Art Storage, Bushwick Facility**

New York-based fine art and fashion storage company UOVO will expand into Brooklyn using discretionary tax benefits from the New York City Industrial Development Agency. UOVO acquired 105 Evergreen Avenue in Bushwick for their forthcoming facility, set to open in fall 2019. Since opening in 2014, UOVO has become New York's number one provider of storage and services for artists, collectors, fashion houses, galleries, museums and more. UOVO: BROOKLYN is a valuable addition to the area's burgeoning art scene. A full-time staff of technical experts, art handlers, drivers and client service specialists will work onsite, creating valuable job opportunities, including 30 local jobs through HireNYC. The facility will be a dynamic hub for art storage, fashion storage, conservation projects and viewing rooms. Additionally, the company has partnered with the Brooklyn Museum to support arts in the community through grants to local artists and exhibition of their work.



*Moore Street Market Plaza  
Credit: CycloMedia*

### **FEATURED PROJECT:**

#### **Moore Street Market**

The historic Moore Street Market has been serving the Bushwick and East Williamsburg communities for over 75 years. Located near the Graham Avenue shopping district, the 15,000 square foot enclosed market is operated and managed by NYCEDC, and offers affordable retail space for rent to entrepreneurs and small businesses. The market has a unique set of vendors that reflect the rich diversity of the surrounding communities and sell a variety of products, including produce and groceries, beauty supplies, and a coffee shop and bakeries. Currently, there are 15 market vendors including prepared food, barber, tailor, grocery, and various other specialty items. NYCEDC is accepting applications for new vendors on an ongoing basis - [more information can be found here](#). With the assistance of a new community partner, NYCEDC will engage the Bushwick community through small business workshops, cooking classes in the new demonstration kitchen, activation of the public plaza, public art, and cultural programming. The local partner will better promote vendor spaces available at Moore Street Market as well as opportunities to participate in pop-up activations and other special events.



# Community Health and Resources

**18%**

**of adults in Bushwick are uninsured compared to 12% uninsured New Yorkers citywide.**

*NYC DOHMH, Community Health Survey, 2015-2016*

Bushwick’s rich community and cultural resources, such as hospitals and clinics, schools, historic buildings, and arts and cultural organizations, contribute to the neighborhood’s distinctive character and identity. Access to quality health care, education, arts programming, and historic resources are essential components of a healthy and livable neighborhood. The Bushwick Neighborhood Plan proposes strategies to strengthen Bushwick’s community and cultural assets to ensure neighborhood vitality in the long-term.

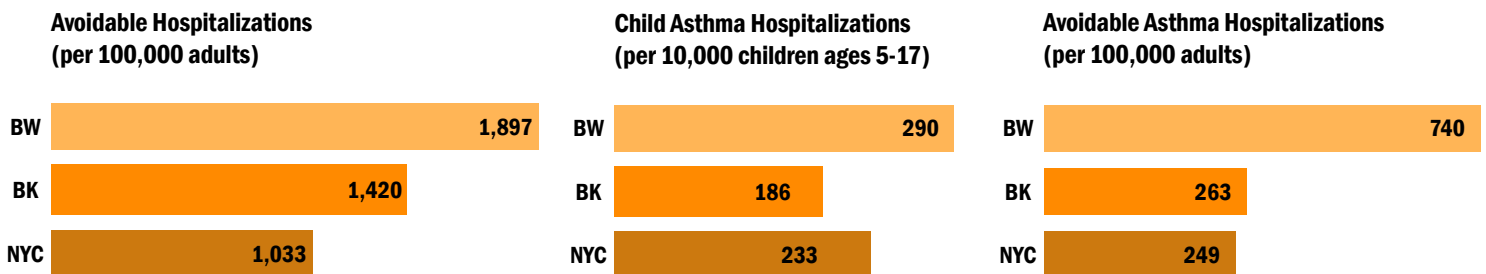

*New York State Department of Health, Statewide Planning and Research Cooperative System, 2012-2015*

## HEALTH

The Bushwick neighborhood faces dramatic disparities in health. [The 2018 Community Health Profile](#) shows that Bushwick residents die prematurely (before the age of 65) at a higher rate than other New Yorkers. This is avoidable, unfair, and unjust. The health inequities that Bushwick residents face are the result of decades of policy and practices that shape the conditions of the neighborhood’s housing, the quality of the food they eat, and the employment opportunities they can access. Creating a healthier Bushwick will require coordination from policymakers, City agencies, community-based organizations, and everyday residents to address these social determinants of health.

### Actions

- Support expanded access to opioid treatment and programs; and increase naloxone distribution and overdose prevention through syringe exchange programs and community-based overdose prevention programs.
- Assess opioid overdose “hot spots” in the community and deploy health staff to distribute naloxone and information to minimize risks of more harm to people in those areas.
- Expand Tuberculosis testing, evaluation, and treatment services to undocumented persons through participation in various health fairs and community events.
- Continue providing technical assistance to food retailers to make healthy changes in their inventory through the [Shop Healthy Program](#).
- Support community-based organizations in implementing nutrition education at farm stands and farmers markets through resources, tools and technical assistance.
- Conduct outreach to and encourage community gardens with a farmers market or food stand to apply for DOHMH grants to implement nutrition education.
- Explore community-based food strategies, such as farmers markets and urban agriculture, to increase access to fresh, healthy food for NYCHA residents in Bushwick and support NYCHA resident food entrepreneurship.
- Expand the STEP UP program that provides free sexually transmitted infection (STI) education, testing, and treatment for public high school students from the Academy of Urban Planning on the Bushwick High School campus to other public schools.
- Help older adults age-in-place safely as part of the [OneNYC DOHMH](#) falls prevention efforts.

### FEATURED PROJECT:

#### Shop Healthy NYC!

The [Shop Healthy NYC!](#) program aims to increase access to healthy food in neighborhoods with high rates of diet-related disease and limited availability of high quality, affordable and nutritious foods. The program works with residents, food retailers, food suppliers and distributors in areas with limited access to nutritious foods. Since 2012, Shop Healthy NYC has worked with more than 1,469 shops in East and Central Harlem, the South Bronx, and Central Brooklyn to promote healthy foods such as fresh fruits and vegetables, low-fat milk and dairy products, and low-salt and no-sugar-added canned goods.

Shop Healthy NYC! began working in Bushwick (Zip code 11237) in July, 2018. 94 food retailers were found eligible to receive programming, 68 (72%) of which agreed to promote healthy food options in their stores. Of these 68 stores, 60 (67%) are currently participating in the retail challenge. Shop Healthy will work with these retailers to increase the availability and promotion of healthier options such as healthy sandwich meal combos, featuring water at eye level height, and removing advertising from the entry door, among other interventions.



Supermarket Square Footage  
(per 100 population)

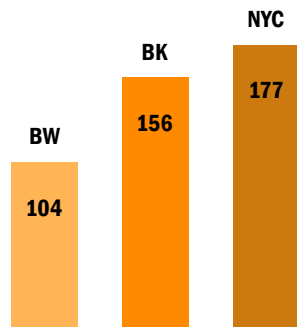

New York State Department of  
Agriculture and Markets, 2014

For every **1**  
supermarket in  
Bushwick there are  
**30** bodegas.

New York State Department of  
Agriculture and Markets, 2016

## Objective: Expand access to quality public health services and programming in Bushwick

- Provide resources and services to support residents who are at risk of drug-related overdose through outpatient treatment and syringe exchange programs.
- Increase awareness among pregnant people of their right to receive respectful, safe and quality care during and after childbirth through the [NYC Standards for Respectful Care](#).
- Increase access to testing and educational information about communicable diseases, such as Tuberculosis and Hepatitis C, through peer and patient navigation services, resource fairs, and mobile testing events.

## Objective: Create healthier homes in Bushwick to address the neighborhood's high asthma rates

- The Department of Health and Mental Hygiene's (DOHMH) [Healthy Neighborhoods Program](#) will accept referrals from health care providers of patients with diagnosed moderate or severe persistent asthma for a home inspection of mold, rats, and roaches.
- Expand and adapt the home health hazards training program to meet the needs of Bushwick residents. Trainings focus on hazards such as pests, mold, and lead poisoning.

## Objective: Provide resources and support to improve mental health in Bushwick

- Engage community members to provide input on mental health messaging campaigns to dispel stigma through strategies developed with the New York Academy of Medicine.
- Through [Thrive NYC](#), train community members in Mental Health First Aid to increase their capacity to support others who may be suffering from mental health conditions, and reduce biases against mental illness.
- Provide mental health services, including mental health first aid trainings, in some neighborhood public schools through [Thrive NYC](#).

## Objective: Improve access to fresh, healthy, and affordable quality food

- Expand the [Shop Healthy](#) program to Bushwick.
- Establish a directory of food pantries that can be shared at social service organizations (see [Plentiful App](#), created by the NYC Food Assistance Collaborative).

## HISTORIC PRESERVATION

### Actions

- Landmarks Preservation Commission (LPC) will evaluate the three historic district study areas and six individual buildings included in the BCP. Historic district study areas include Northeast Bushwick (the area roughly bounded by Ridgewood Place, Knickerbocker Avenue and Putnam and Halsey streets), Moffat Street between Central and Evergreen avenues, and Bushwick Avenue between Greene and Madison streets. The BCP's recommended individual landmarks include Little Sisters of the Poor, Home for the Aged, Public School 52, Hamburg Savings Bank, Ulmer Rowhouses, 71 Cornelia Street, and Arion Hall.
- Beginning in April 2019, LPC will undertake a reconnaissance level survey of the three proposed districts which will enable LPC to define boundaries for study areas that merit an intensive level survey and future outreach.

### Objective: Protect Bushwick's historic resources through historic preservation tools

- LPC has designated 12 individual landmarks in Bushwick that reflect its residential, civic and manufacturing history. Designations include prominent residential buildings such as the Catherina Lipsius House and the Doering-Bohack House, and most recently the Peter P. and Rosa M. Huberty House at 1019 Bushwick Avenue. Bushwick's important history as a center for Brooklyn's breweries and German residents is represented by the designation of both the William Ulmer Brewery complex and Ridgewood Lodge No. 710. Bushwick's civic history is represented by the designations of Brooklyn Public Library, DeKalb Branch, Engine Company No. 252, PS 86, PS 116, and the 20th Precinct Police Station House and Stable. Two prominent churches include St. Barbara's Roman Catholic Church and the Reformed Church of South Bushwick.



Individual landmark: Doering Bohack House



Individual landmark: Ulmer Brewery

### Objective: Protect Bushwick's neighborhood character and scale through contextual zoning

- Map contextual zoning districts that limit the height of buildings in areas identified for their distinctive character to reinforce a sense of place and respond to surrounding context.
- DCP will work with LPC to identify areas in which the historic streetscape character could be preserved via contextual zoning.

## ARTS AND CULTURE

**Objective: Ensure that the support of neighborhood-based arts and culture enables existing communities and cultures to thrive in place**

- City agencies should partner with the Community Board and the cultural sector to better communicate existing neighborhood cultural assets and programs across socio-economic, accessibility, and language barriers.

### **FEATURED PROJECT: Building Community Capacity Program**

In 2017, Bushwick successfully applied to participate in the second round of the Department of Cultural Affairs' (DCLA) Building Community Capacity program (BCC). BCC supports the ability of local stakeholders to leverage arts and culture in creating thriving, equitable neighborhoods.

For Phase I of the program, from January to June 2018, grantee partners El Puente and Bushwick Starr led a research and discovery process consisting of asset mapping and extensive engagement with local residents and workers. The result is a Neighborhood Arts and Cultural Inventory (Spring 2019), which will serve as a springboard to build on strengths and address challenges.



*El Puente*

### **ACTION**

- In Phase II, which will launch in fall 2019, BCC will support the broader Bushwick community in developing strategies to ensure that local arts and culture supports the priority needs of residents, such as addressing barriers to access, increasing awareness of existing opportunities, and bringing about meaningful, sustainable change.



AUTO GLAS

AUTO GLAS

CITY SPEED  
25

"I'M BLACKER  
THAN  
MIDNIGHT ON  
BROADWAY &  
MIDWINTER"



# Transportation

Access to transit, safe and walkable streets, and quality public spaces are critical building blocks of a healthy, vibrant community. Bushwick is well-served by transit on its major corridors, including the J, M, Z, and L trains as well as nine bus routes. Despite being well-served by transit overall, Bushwick only has three Americans with Disabilities Act (ADA) accessible stations serving the area. The Metropolitan Transit Authority (MTA) and DCP are working together to address this issue through a mix of MTA capital improvements and zoning changes to map transit easements adjacent to subway stations.

In terms of pedestrian and cyclist amenities, a public plaza was recently established at the Myrtle-Wyckoff transit hub and the bicycle network is growing. In addition, through its Vision Zero Pedestrian Safety Action Plan, Department of Transportation (DOT) identified priority corridors and intersections in Bushwick for safety engineering, enforcement, and education initiatives. Of these corridors, Bushwick's elevated train corridors, Broadway and Myrtle Avenue, face acute challenges due to complex intersections with sharp angles. DOT has studied Myrtle Avenue and sections of Broadway in the Bushwick Neighborhood Plan study area for potential safety improvements and is beginning to undertake interventions.

In addition to pedestrian safety issues, areas under the elevated train can be dark and unwelcoming. By exploring possible lighting, street furniture, and zoning interventions to bring greater light and vibrancy to these corridors, DCP and DOT are working to address the pedestrian environment under the elevated. See more on relevant zoning changes on p.62 of the Land Use and Zoning section. Taken together, these strategies and the others listed below aim to enhance safety and mobility, promote cohesive streetscapes and public spaces, and improve local transit access as the neighborhood grows and land use patterns change.



*Myrtle Ave Station on the J, Z, M subway lines*

## Actions

- In late 2018, DOT implemented a pedestrian safety project at Broadway and Flushing Avenue, a Vision Zero Priority Intersection. The project expanded the crosswalk to better align with the subway station stairs and installed a hardened centerline to better protect pedestrians from left-turning vehicles.
- In 2018, DOT installed 3.4 miles of bike lanes on Troutman Street, Starr Street, Central Avenue, and Evergreen Avenue as part of its Bushwick Community Bicycle Network and the neighborhood's Priority Bicycle District designation.
- Add six temporary Citi Bike stations and pursue additional Citi Bike expansion for Bushwick in 2019.
- DOT is finalizing its design for the Wyckoff Avenue capital street reconstruction, with construction anticipated to start in 2020. The Myrtle/Wyckoff Plaza reconstruction is also part of this capital project. Existing plaza geometry, including the neckdowns at the intersection of Myrtle and Wyckoff avenues, will be reconstructed, making permanent safety enhancements at a location that saw three fatalities prior to the creation of the plaza. The reconstructed plaza will include both fixed and movable seating; utility allowances for a potential future kiosk; and open, flexible areas for a variety of programming types, including markets. The plaza is currently and will continue to be managed by DOT as part of the [OneNYC Plaza Equity Program](#) with maintenance services provided by the Horticultural Society of New York.
- To facilitate better access to transit stations through off-street relocation of subway entrances, include transit easements for future development of sites within 50 feet of MTA subway station envelopes.
- The MTA is currently exploring ADA improvements for stations on the L line in Northwest Bushwick and East Williamsburg as well as on the J/Z line east of Myrtle Avenue in Bushwick.
- Platform repairs and improvements are planned for stations throughout Bushwick along the L line.
- In 2018, the M line along Myrtle Avenue underwent significant rehabilitation, including reconstruction of the Myrtle Avenue viaduct.



*Enhance public spaces  
(Myrtle/Wyckoff Plaza)*



*Explore bike infrastructure expansion  
(Knickerbocker Avenue)*



*Improve pedestrian crossings  
(Broadway and Flushing Ave)*



Under the El project seating prototype.  
Credit: Ciocchini Design

## Objective: Enhance pedestrian safety and mobility for Bushwick residents and visitors

- Evaluate key corridors and intersections for Vision Zero safety projects, such as Myrtle Avenue and Broadway.
- Advocate for transportation and infrastructure improvements that consider the needs of children, seniors, and those with special needs.
- Explore adding bike lanes and bike parking to extend and fill gaps in the bike network.
- Coordinate Citi Bike expansion in Bushwick.
- Evaluate corridors for truck safety engineering improvements and upgrade truck route signage.

## Objective: Promote cohesive streetscapes with quality public spaces, wayfinding, and lighting

- Work with local partners on plaza programming and additional amenities such as public art, wayfinding signage, and street furniture.
- Explore and identify opportunities for uniform lighting, plantings space, and other treatments to improve conditions under elevated infrastructure throughout Bushwick, particularly at transit nodes.

## Objective: Enhance local transit access, connections, and service

- Add amenities such as CityBench, leaning bars, and real-time passenger information to high ridership bus stops in Bushwick.
- Evaluate bus priority improvements, such as bus lanes and transit signal priority, along routes to downtown Brooklyn.
- Continue annual investments in all aspects of the transit system to bring infrastructure to a state of good repair.
- Perform a comprehensive Brooklyn bus network study in the next three years with the objective of redesigning Brooklyn's bus network.
- Improve accessibility in the transit system to have a system where no customer is more than two stations away from an accessible station.

# Community District 4 Vision Zero and Crash Map

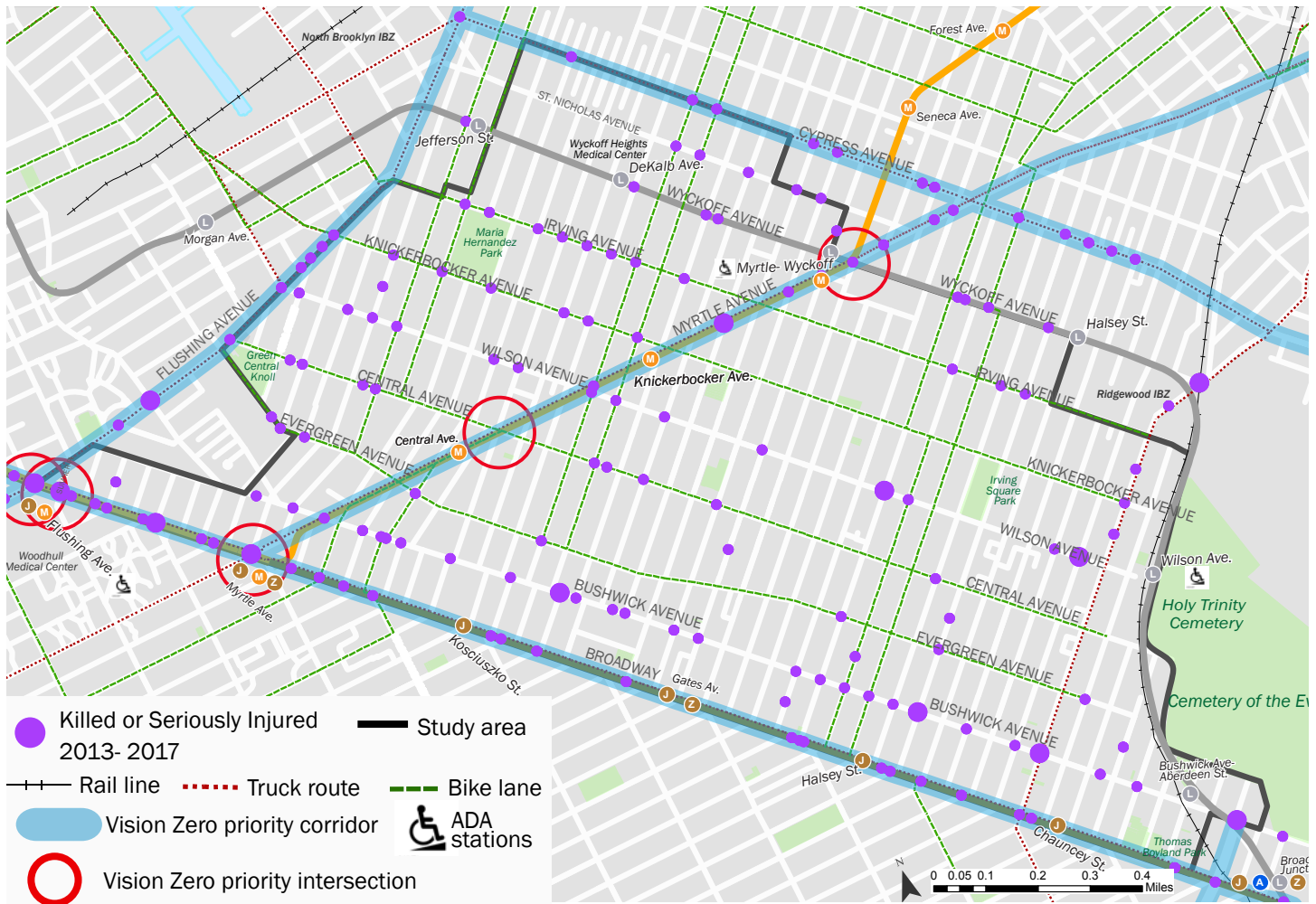

[Vision Zero](#), launched in 2014, is New York City’s multi-agency, data-driven initiative to eliminate traffic deaths and serious injuries through engineering, enforcement, and education. The City has undertaken a robust portfolio of street design changes, re-engineering intersections and corridors for safety. Completed projects within Bushwick include bike lane installations, crosswalk upgrades, intersection visibility improvements, and lane narrowing throughout the neighborhood, as well as parking and loading restrictions along Broadway.

Between **2009-2013** and **2012-2016** pedestrians killed or severely injured per mile on **Bushwick Avenue** dropped

**50%**

Between **2009-2013** and **2012-2016** pedestrians killed or severely injured per mile on **Knickerbocker Avenue** dropped

**60%**

**57** pedestrian injuries were reported along Myrtle Avenue between Broadway and Irving Avenue from 2013-2017

**10** persons killed or severely injured were reported along Myrtle Avenue between Broadway and Irving Avenue from 2013-2017

NYCDOT, NYSDOT/NYS DMV Accident Database, NYSDOT/NYPD Reconciled Fatality Database

## FEATURED PROJECT: Myrtle Avenue Safety Improvements

In 2019, DOT plans to implement corridor safety improvements along Myrtle Avenue in Bushwick between Broadway and Irving Avenue. DOT plans to install eight new crosswalks along pedestrian desire lines and curb extensions at seven intersections in order to shorten crossing distances, encourage safer and slower turns, and clarify movements around subway columns. DOT will also be pursuing lighting improvements along the corridor to increase visibility, focusing on the areas below M train stations. These changes will bring important safety improvements to a Vision Zero Priority Corridor that will benefit everyone who uses or passes through Myrtle Avenue.

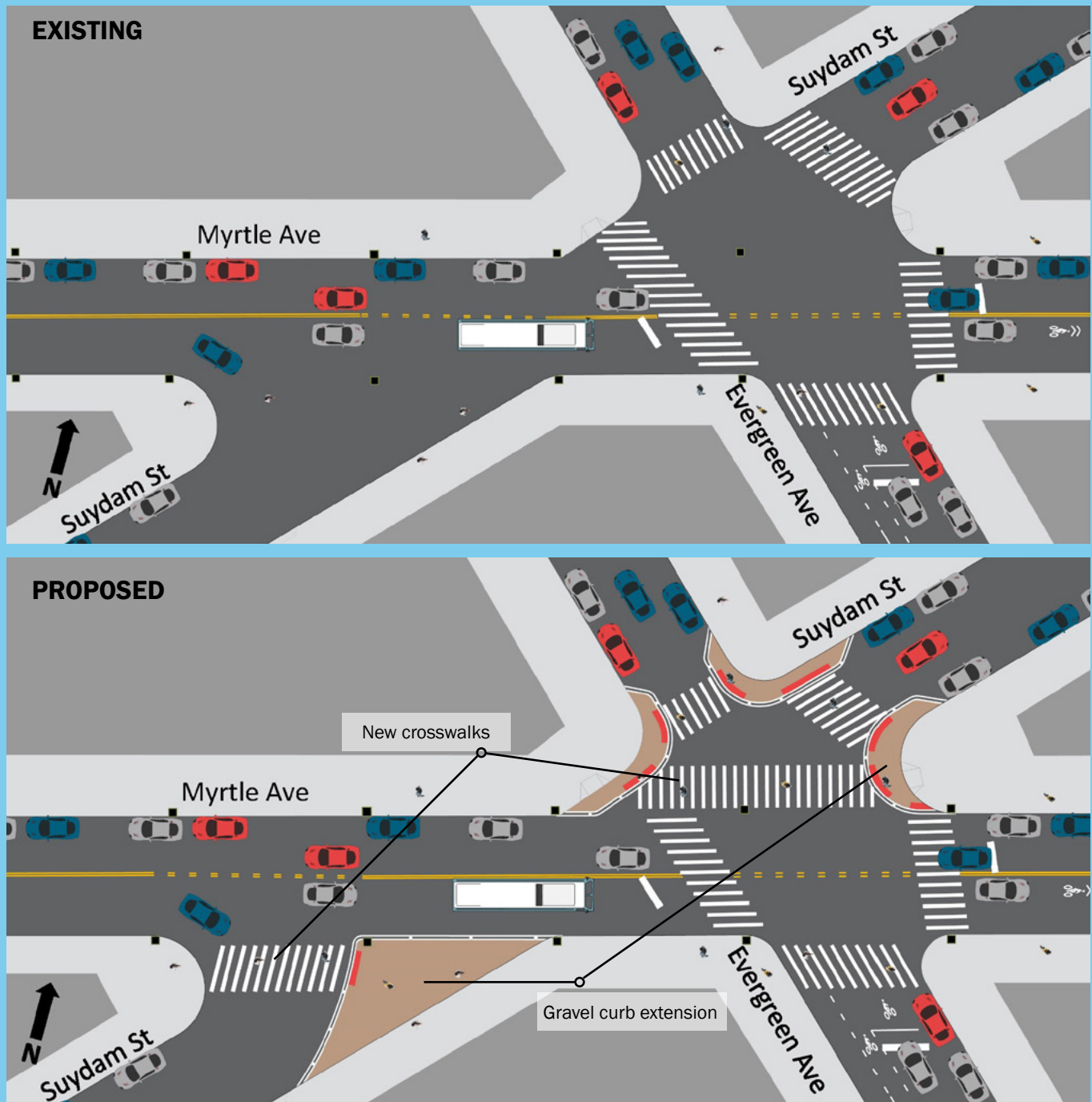

Suydam Street and Myrtle Ave. At this intersection, DOT plans to install new crosswalks and a curb extension that shortens crossing distances



1215

DEAD  
END

Teardrop's

Teardrop's

# Land Use and Zoning

The Bushwick Neighborhood Plan Update proposes a planning framework and zoning proposal that identify a vision for a balanced, coordinated approach to neighborhood planning. The zoning proposal will enable the protection of neighborhood character, appropriate residential and commercial growth, and maintenance of locations for job-generating uses and business expansion.

The planning framework takes into account community aspirations and priorities shared at Land Use Sub-committee meetings, the Land Use and Housing Summit held in February 2017, the subsequent zoning workshop series held from May through August 2017, and the Bushwick Community Plan final report, released in September 2018. DCP's planning framework has evolved over time to strengthen protection of midblock character and maintenance of job generating uses, in response to stakeholder feedback throughout the process. The framework contains specific land use objectives to guide a long-term vision for the future of Bushwick, which, based on ongoing outreach and agency efforts, recognize the area's varied context and aim to meet multiple objectives. As the City proactively plans for the neighborhood's future, the framework also seeks to meet citywide goals of increasing housing production, including affordable housing, and directing growth to appropriate locations.

# BUSHWICK PLANNING FRAMEWORK

## Legend

- Midblock Preservation:** Preserve character of side streets by continuing to allow low-scale residential buildings and limiting height (i.e. contextual zoning).
- Historic Corridor:** Maintain historic character through contextual zoning tools.
- Mixed Use Corridor:** Allow medium density development with affordable (MIH\*) and mixed income housing and strengthen commercial uses.
- Neighborhood Corridor:** Explore potential for medium density development with affordable (MIH\*) and mixed income housing and retail where appropriate.
- Transit Corridor:** Promote higher density mixed-use development with affordable (MIH\*) and mixed income housing, retail, and community facility uses.
- Industrial/Commercial Buffer Zone:** Foster the creation of industrial/commercial nodes through increased density and reduced parking and loading requirements.
- Established Residential:** Bring areas with substantial established residential uses into conformance with medium density along corridors and lower density on midblocks.
- Mixed Use Area:** Encourage the continuity of the mix of uses present today - industrial, commercial, and residential.





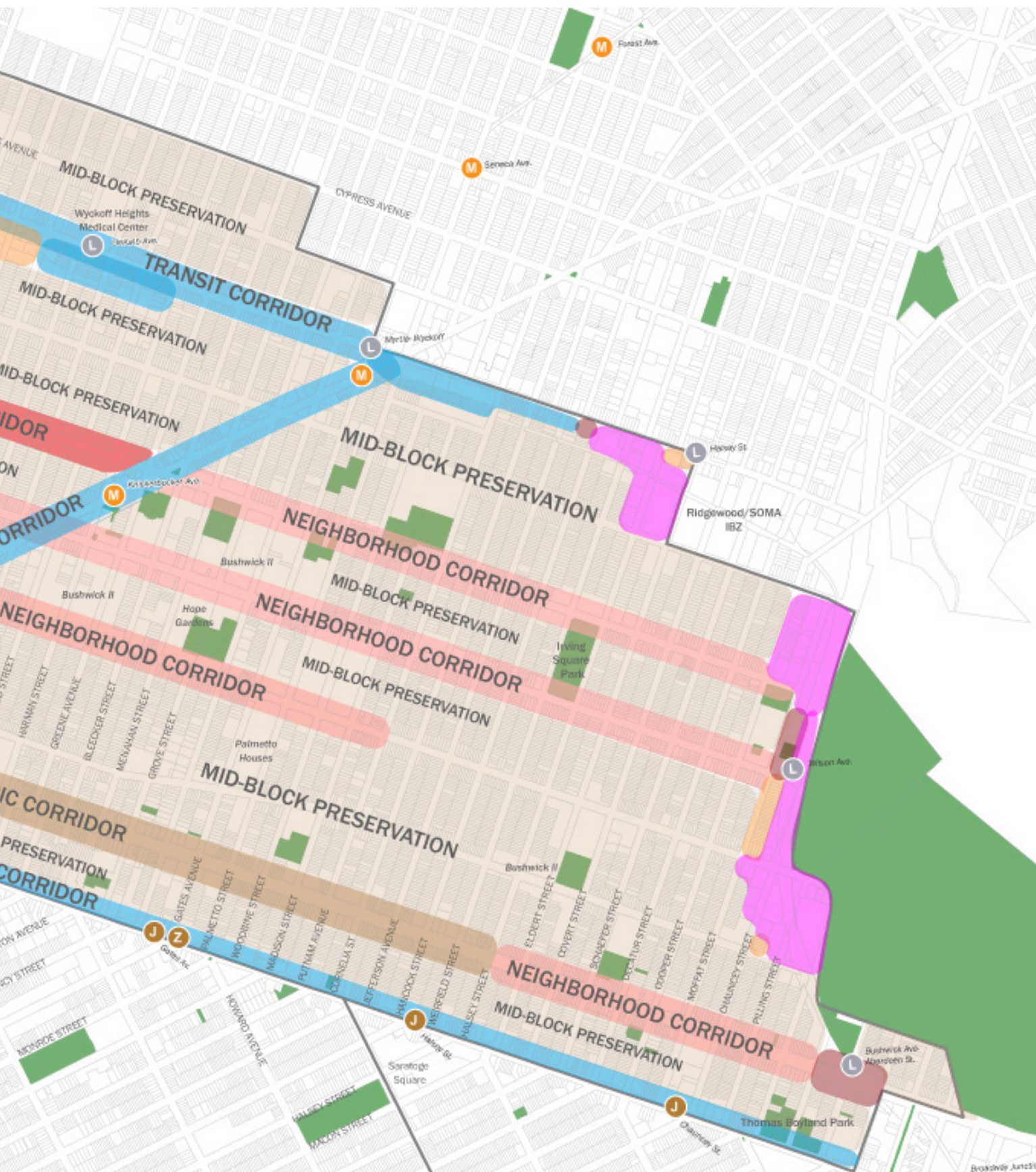

## MIDBLOCK PRESERVATION

**Objective: Reinforce predominant character of side streets and select corridors by matching zoning to the low-scale residential buildings and limiting building heights (i.e. contextual zoning) accordingly.**

### What we heard/Vision:

- Adopt contextual zoning that would limit heights and maintain existing character.
- Prevent out-of-scale residential additions where possible.
- Use a fine-grained block-by-block approach to mapping zoning districts.
- Protect midblock low-rise character on Irving Avenue east of Myrtle Avenue.
- Protect midblock low-rise character on Central Avenue east of Putnam Avenue.
- Careful consideration of zoning in NE Bushwick, east of Putnam Avenue, an area with intact consistent rowhouse character.

### Strategies

- Implement zoning that would maintain the character of side streets by continuing to allow low-scale residential buildings, limiting height, and ensuring that buildings line up on the street with those next to them.



*Midblock: Troutman Street between Evergreen and Bushwick avenues*

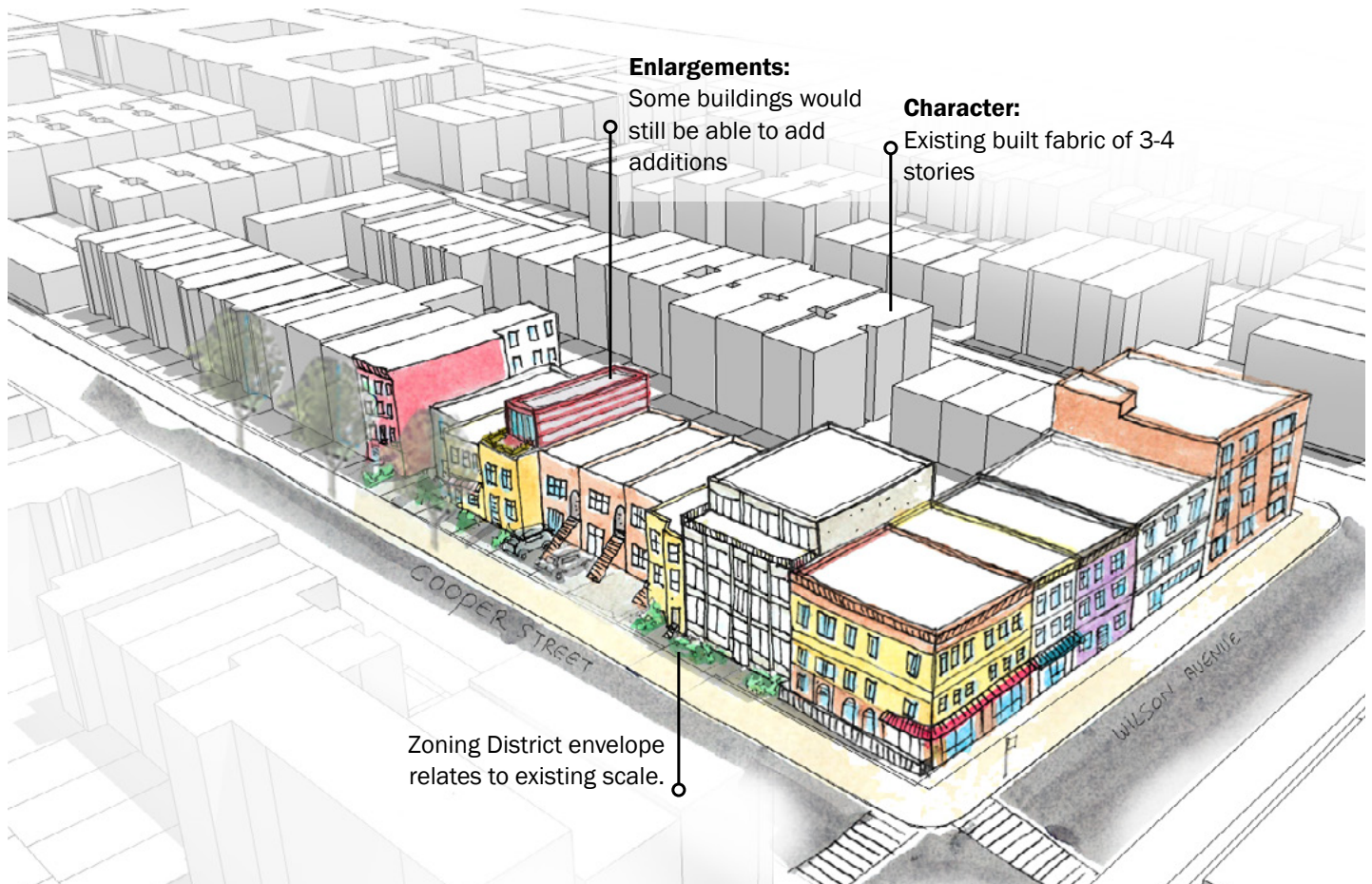

## TRANSIT CORRIDORS

**Objective: Promote higher density mixed-use development, including permanently affordable housing as well as mixed-income housing, local retail, and community facilities.**

### What we heard/Vision:

- Greater density with Mandatory Inclusionary Housing (MIH) mapped close to transit stations and key sites.
- More street activity, especially on stretches of Broadway and Myrtle Avenue that currently lack commercial activity.
- Streetscape improvements and design interventions to increase safety and “brighten” Broadway and Myrtle Avenue in the dark spaces under the elevated train.
- More modest growth on Wyckoff Avenue, compared to Broadway and Myrtle Avenue, given the consistent three-story character west of Myrtle Avenue.

### Strategies

- Map MIH, which requires permanently affordable housing in new residential developments within upzoned areas.
- Enliven streets by requiring active uses, such as stores or community facilities, on the ground floor (i.e. enhanced commercial districts).
- Allow non-residential uses to locate on upper floors to encourage job growth.
- Regulate built form that responds to the elevated train corridor condition by including provisions requiring building setbacks (sidewalk widening) beside train stations and above the second floor.



Myrtle Avenue



Broadway

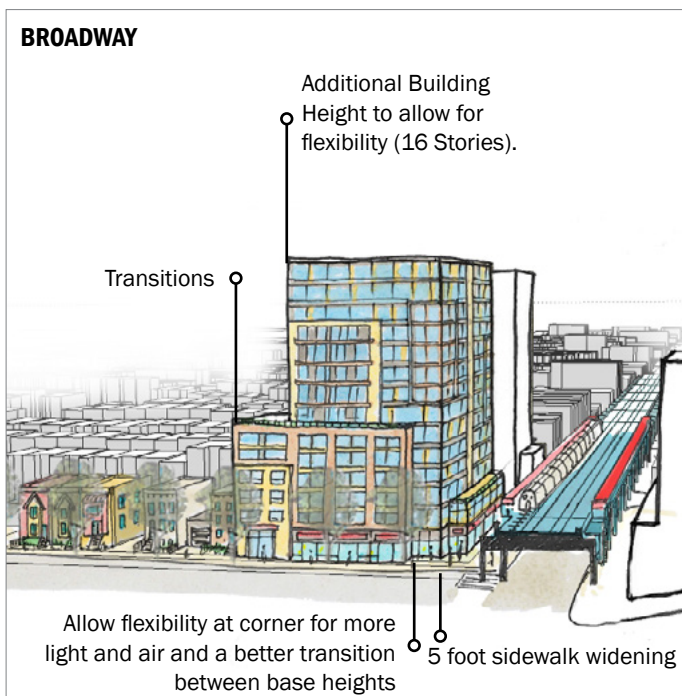

Massing for C4-4D (7.2 FAR)

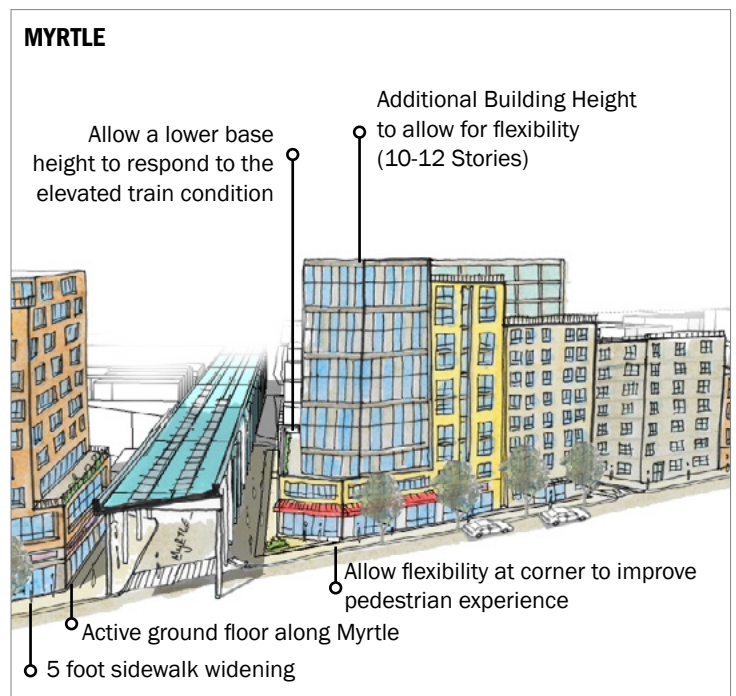

Massing for C4-5D (5.6 FAR)

## NEIGHBORHOOD CORRIDORS

**Objective: Explore potential for medium density development with permanently affordable housing, mixed income housing, and retail where appropriate.**

### What we heard/Vision:

- Do not view Knickerbocker Avenue, Wilson Avenue, and Central Avenue as growth corridors overall and avoid a blanket approach to zoning. Treat portions of the avenues west and east of Myrtle Avenue differently, with slightly greater density and taller buildings further west.
- Maintain overall character of the neighborhood corridors, but with improved amenities and better access to commercial uses at key locations.
- Map MIH at key sites or nodes, with housing and greater density close to transit nodes on Myrtle Avenue.
- Map commercial overlays at appropriate locations, including overlays in gaps where there are commercial uses today and no existing overlays (e.g. Knickerbocker Avenue between Starr and Suydam streets across from Maria Hernandez Park and between Jefferson and George streets).
- More commercial uses further west, and maintain already existing commercial uses further east.

### Strategies

#### West of Myrtle Avenue:

- Encourage existing active commercial corridors.
- Increase density only in areas where opportunity for MIH exists and maintain existing density in other areas to preserve neighborhood character.

#### East of Myrtle Avenue:

- Maintain existing commercial activity at nodes and close to transit.
- In areas that have consistently lower density (e.g. parts of Irving Avenue and Central Avenue) or where buildings are oriented towards side streets, implement zoning that would maintain the built character by continuing to allow low-scale residential buildings, limiting height, and ensuring that buildings line up on the street with those next to them.



Central Avenue



Wilson Avenue



Knickerbocker Avenue

## HISTORIC CORRIDOR



*Catherina Lipsius House on Bushwick Ave*

**Objective: Protect neighborhood character and scale through contextual zoning.**

### What we heard/Vision:

- Maintain the historic character of Bushwick Avenue and prevent out-of-context development.
- Establish a historic district for sections of Bushwick Avenue or designate individual historic landmarks.

### Strategies:

- Map contextual zoning districts that limit the height of buildings in areas identified for their distinctive low-rise character, such as Bushwick Avenue between Myrtle Avenue and Halsey Street.
- DCP will work with LPC to identify areas in which the historic streetscape character could be preserved via contextual zoning.

## MIXED-USE CORRIDORS



*Knickerbocker Avenue at Stockholm Street*

**Objective: Allow medium density development with permanently affordable housing and mixed income housing, and strengthen commercial uses.**

### What we heard/Vision:

- Encourage both continuity and strengthening of Knickerbocker Avenue's commercial character.
- Housing and greater density close to the transit node at Myrtle Avenue.
- Maintain and see more multi-story commercial use.
- Require ground-floor commercial uses in key locations where appropriate.

### Strategies:

- Increase density around transit and at key sites.
- Map MIH, which requires permanently affordable housing in new residential developments within upzoned areas.
- Require ground floor commercial use to support population growth and reinforce the character and viability of existing commercial corridors.
- Continue to work with SBS on strategies to strengthen local businesses.
- Explore strategies to increase pedestrian and bike safety on Knickerbocker Avenue, which connects important public spaces in Bushwick, including Maria Hernandez Park and Irving Square Park.

## INDUSTRIAL/COMMERCIAL BUFFER ZONE

**Objective: Reinforce and allow for growth of industrial and commercial uses and strengthen as a local job hub.**

### What we heard/Vision:

- Retain existing industrial uses, as well as support growth and expansion of job-generating uses.
- Maintain prohibition on new residential uses in these areas.
- Increase density for non-residential uses along Flushing Avenue corridor.
- Encourage more retail and services in eastern Bushwick, which is currently under-served.

### Strategies:

- Continue to prohibit new residential uses and allow a range of non-residential uses – industrial, commercial, community facility.
- Encourage development of new businesses by increasing the allowable floor area ratio (FAR) for non-residential uses to 2 to 5 FAR.
- Eliminate parking requirement and rightsize loading requirements to better support business needs.



*Beverage distributors, Knickerbocker Avenue*



*Restaurant, Starr Street.*

*Credit: CycloMedia*

## ESTABLISHED RESIDENTIAL

**Objective: Bring existing residential blocks into conformance with zoning.**

### What we heard/Vision:

- Bring areas with consistent residential character into conformance with zoning.
- Allow existing businesses to remain.

### Strategies:

- Allow residential and, where appropriate, commercial and industrial use.
- Allow medium-scale density along corridors and lower density on midblocks.
- Map MIH, which requires permanently affordable housing in new residential developments within rezoned Manufacturing areas.



*Moffat Street between Wilson and Central avenues*

## MIXED-USE AREA

**Objective: Encourage continuity of unique mix of uses, allowing businesses to remain and expand, while also bringing existing residential uses into conformance with zoning.**

### **What we heard/Vision:**

- Support existing businesses, and allow them to grow and expand.
- Allow for job growth and job-generating uses.
- In eastern Bushwick, more retail and services for workers and residents, including places for families to go.
- On large sites, encourage uses with a benefit to the community, including space for jobs, affordable housing, and open space.

### **Strategies:**

- Encourage a mix of residential, commercial, and industrial uses, which would bring existing uses into conformance and allow new housing and business growth.
- Support existing businesses by allowing them to grow and expand;
- Encourage development of new businesses by increasing allowable FAR for non-residential uses at 2 to 5 FAR.
- Eliminate parking requirement for non-residential uses and rightsize loading requirements to better support business needs.
- Map Mandatory Inclusionary Housing (MIH), which requires permanently affordable housing in new residential developments within rezoned industrial areas.



*Willoughby Ave between Wyckoff Ave And Irving Ave.*

*Credit: CycloMedia*

## Zoning Proposal

Taking into account the feedback on the various iterations of the planning framework, the Bushwick Community Plan report, and ongoing City analysis, DCP developed a zoning proposal for the Bushwick neighborhood that aims to achieve a balanced approach to neighborhood growth and address the need for increased affordable housing and economic opportunity while preserving neighborhood character. The zoning proposal refines the planning framework into specific zoning districts that lay the foundation for future development in the neighborhood. The zoning proposal is guided by the following high-level objectives.

**Objectives:** Preserve neighborhood character of Bushwick’s side streets (i.e. mid-blocks) by establishing contextual zoning districts

- Limit building height to be more in context with adjacent low-scale residential buildings.
- Require new development to line up with existing buildings along the street line.

**Proposed Zoning Districts:** R5B, R6B

### Lower Density

|            |            |
|------------|------------|
| <b>R5B</b> | FAR: 1.35  |
|            | STORIES: 3 |
| <b>R6B</b> | FAR: 2.2   |
|            | STORIES: 4 |



Objective: Allow for appropriate growth with permanently affordable housing, retail, and community facilities in appropriate locations on east-west avenues

- Foster neighborhood nodes of activity (commercial, residential use) on Bushwick’s neighborhood and mixed-use corridors, including sections of Knickerbocker, Wilson, Central, and Irving avenues.
- Map commercial overlays to connect gaps between existing overlays and extend vibrant mixed-use character.

**Proposed Zoning Districts:** R6A, R7A

## Medium Density

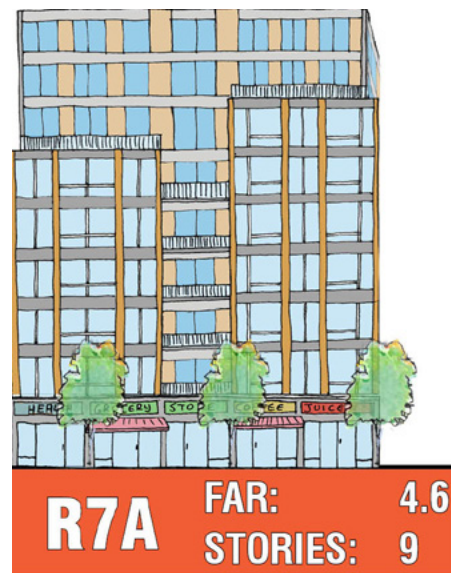
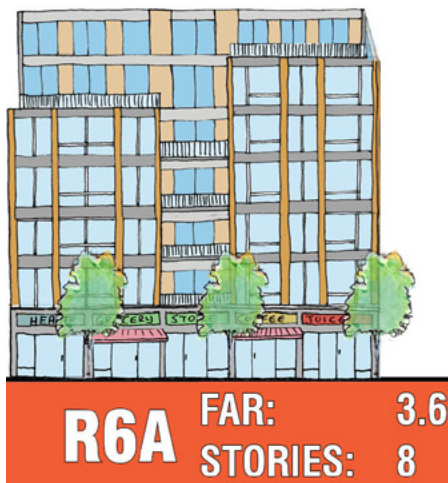

## Objective: Promote higher density mixed-use development with permanently affordable housing close to transit

- Allow for increased density directly adjacent to elevated train stations to encourage nodes with a mix of housing, retail, and community facilities.
- Require active ground-floor use on transit corridors to ensure that ground-floor space is occupied by non-residential (commercial, community facility) establishments that enliven the pedestrian experience.
- Allow non-residential uses to locate on upper floors to encourage job generation;
- Allow a greater range of job-generating uses than the typical commercial districts by permitting custom manufacturing activities (Use Group 11), such as jewelry making and clothing manufacturing on transit corridors.
- Map commercial zoning on corridors where there are commercial uses today to allow new commercial uses to locate there in the future.
- Restrict hotels through a Hotel Special Permit on transit corridors.

**Proposed Zoning Districts:** R7A, C4-5A, C4-5D, C4-4D

## Objective: Allow building envelope flexibility to respond to elevated train conditions and improve the pedestrian experience along elevated train corridors

- Lower required minimum base heights to encourage setback of residential units from the elevated train.
- Allow for additional building heights of up to two stories to allow for greater architectural flexibility and improved urban design.
- Require sidewalk widening beside train stations to improve the pedestrian experience.
- Identify transit easements to be included in future development for sites within 50 feet of MTA subway stations, to facilitate better access to transit stations through off-street relocation of subway entrances.

**Proposed Zoning Districts:** C4-5A, C4-5D, C4-4D



*Broadway and Locust Street*



*Myrtle Ave and Irving Ave*

## Broadway

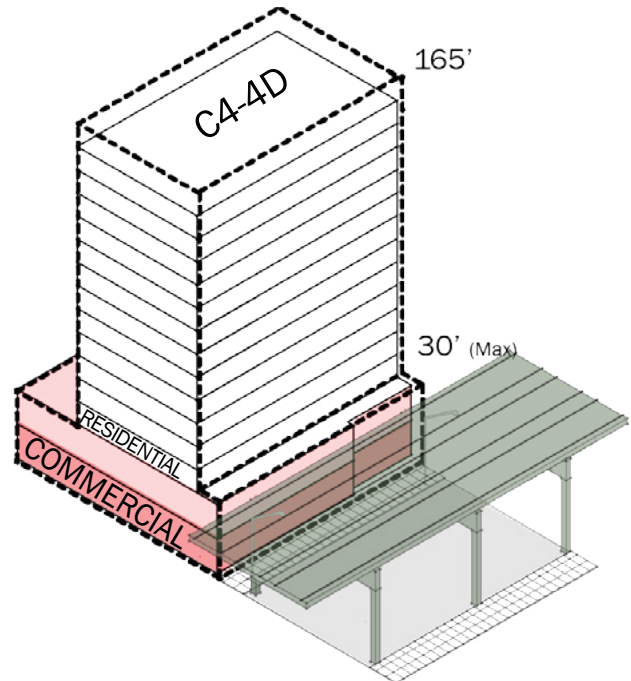
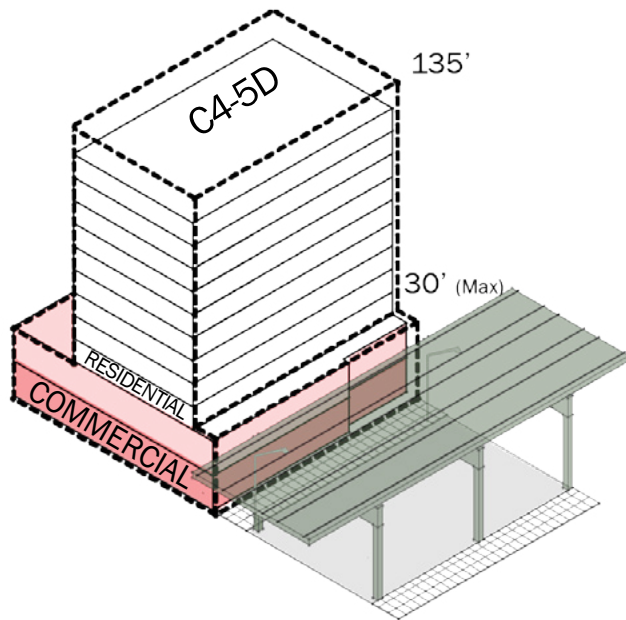

## Myrtle Avenue

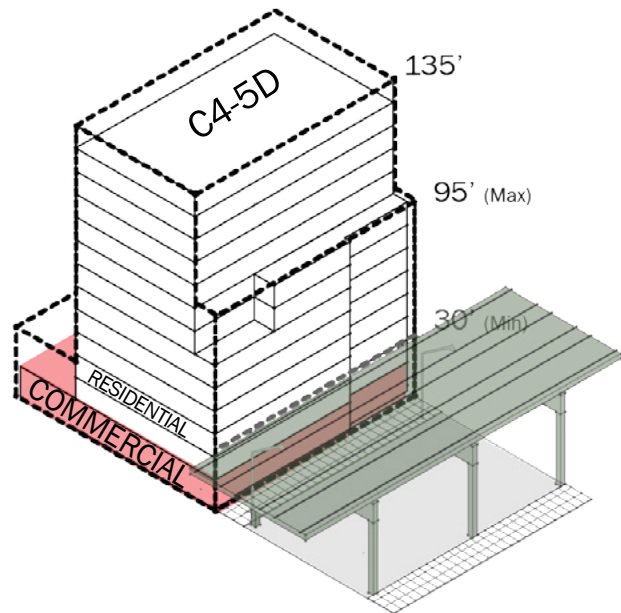
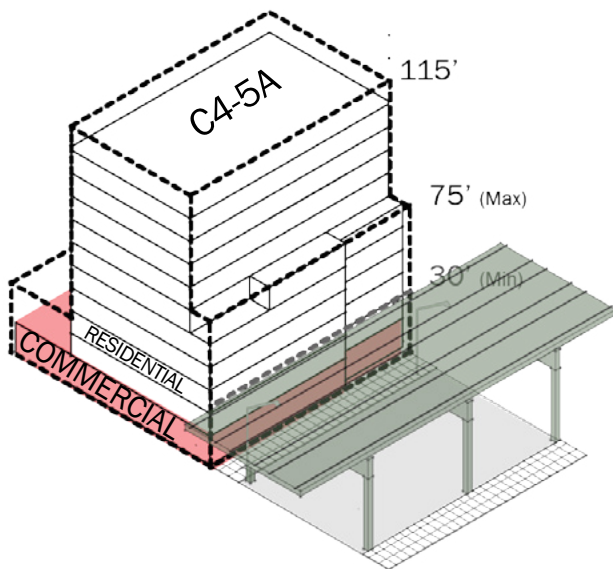

|   | C4-5A (R7A Equivalent)<br>Myrtle Elevated | C4-5D (R7D Equivalent)<br>Myrtle Elevated | C4-5D (R7D Equivalent)<br>Broadway Elevated | C4-4D (R8A Equivalent)<br>Broadway Elevated |
|---|---|---|---|---|
| Residential FAR                                       | 4.6                                       | 5.6                                       | 5.6   | 7.2   |
| Community Facility FAR                                | 4.0                                       | 4.2                                       | 4.2   | 6.5   |
| Commercial FAR  | 4.0                                       | 4.0                                       | 4.0   | 4.0   |
| Min Base Height                                       | 25  | 25  | 15  | 15  |
| Max Base Height                                       | 75  | 95  | 30  | 30  |
| Max Building Height                                   | 115                                       | 135                                       | 135   | 165   |
| Residential Parking                                   | 40%                                       | 40%                                       | 40%   | 40%   |
| Affordable (Income-Restricted)<br>Residential Parking | n/a                                       | n/a                                       | n/a   | n/a   |

## Objective: Reinforce and increase job-generating uses and enhance the vitality of industrial districts

- Maintain prohibition of residential use to strengthen and concentrate job generating uses in areas with active industrial businesses today along Wyckoff and Flushing avenues in northwest Bushwick, and Wyckoff Avenue and Moffat streets in eastern Bushwick.
- To better respond to existing neighborhood character, create new mid-density contextual manufacturing districts that facilitate modern, loft-style buildings with height limits.
- Lower barriers to development on industrial sites through elimination of parking requirements and lowered loading requirements.
- Raise FAR from 1 to 3 to 5, permitting more buildable industrial, commercial, and community facility floor area.
- Establish height limits that respond to surrounding context.



Knickerbocker Ave

## Contextual Manufacturing Districts

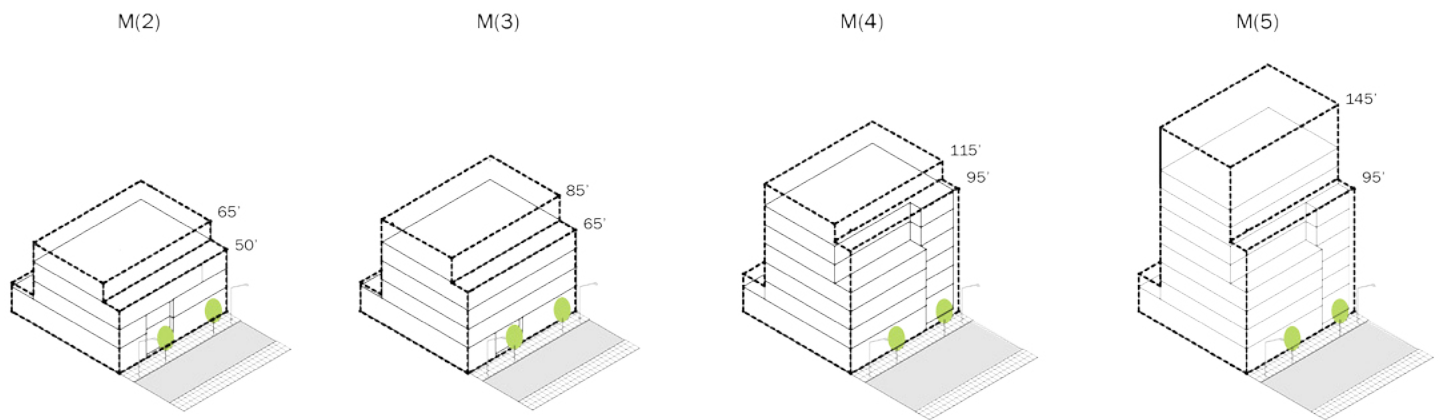

|                        | M(3)     | M(4)      | M(5)      |
|------------------------|----------|-----------|-----------|
| Community Facility FAR | 3.0      | 4.0       | 5.0       |
| Commercial FAR         | 3.0      | 4.0       | 5.0       |
| Industrial FAR         | 3.0      | 4.0       | 5.0       |
| Min Base Height        | 20       | 20        | 20        |
| Max Base Height        | 65 - 95  | 95 - 125  | 125 - 155 |
| Max Building Height    | 85 - 115 | 115 - 145 | 145 - 175 |
| Commercial Parking     | n/a      | n/a       | n/a       |
| Industrial Parking     | n/a      | n/a       | n/a       |

**Proposed Zoning Districts:** M(3), M(4), M(5)

Objective: Encourage a mix of residential, commercial, and industrial uses to best respond to needs for both jobs and new housing, including affordable housing



Jefferson Street  
Credit: CycloMedia

- In areas with a mix of uses today, bring residential uses into conformance and promote continuity and growth of non-residential uses through mapping MX districts.
- As part of MX districts, map new contextual M districts that will better respond to surrounding context through introducing height limits.
- On large sites, map separate industrial (M) and mixed-use (MX) districts to promote non-residential space and economic opportunity while also allowing a mix of uses including residential with permanently affordable housing.

**Proposed Zoning Districts:** M(3), M(4), M(5), R6B/M(2), R6A/M(3), R7A/M(3), R7D/M(4)

**Mixed-Use Districts**

R6B/M(2)

R6A/M(3)

R7A/M(3)

R7D/M(4)

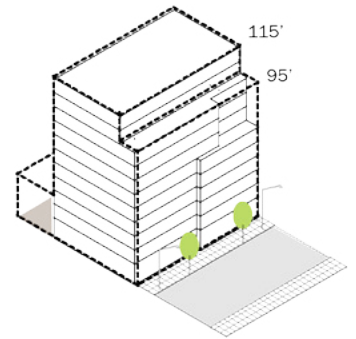
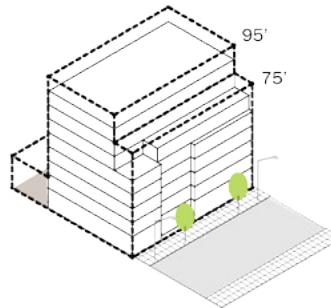
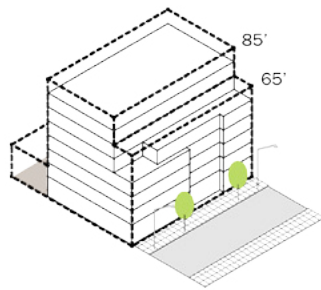
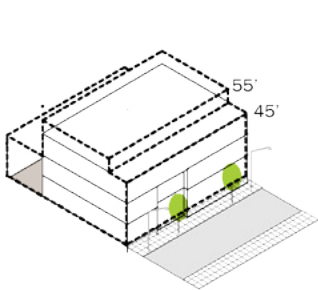

|                        | R6B/M(2) | R6A/M(3) | R7A/M(3) | R7D/M(4) |
|------------------------|----------|----------|----------|----------|
| Residential FAR        | 2.2      | 3.6      | 4.6      | 5.6      |
| Community Facility FAR | 2.0      | 3.0      | 3.0      | 4.0      |
| Commercial FAR         | 2.0      | 3.0      | 3.0      | 4.0      |
| Industrial FAR         | 2.0      | 3.0      | 3.0      | 4.0      |
| Min Base Height        | 30       | 40       | 40       | 60       |
| Max Base Height        | 45       | 65       | 75       | 85       |
| Max Building Height    | 55       | 85       | 95       | 115      |
| Residential Parking    | 50%      | 50%      | 50%      | 50%      |
| Commercial Parking     | n/a      | n/a      | n/a      | n/a      |
| Industrial Parking     | n/a      | n/a      | n/a      | n/a      |

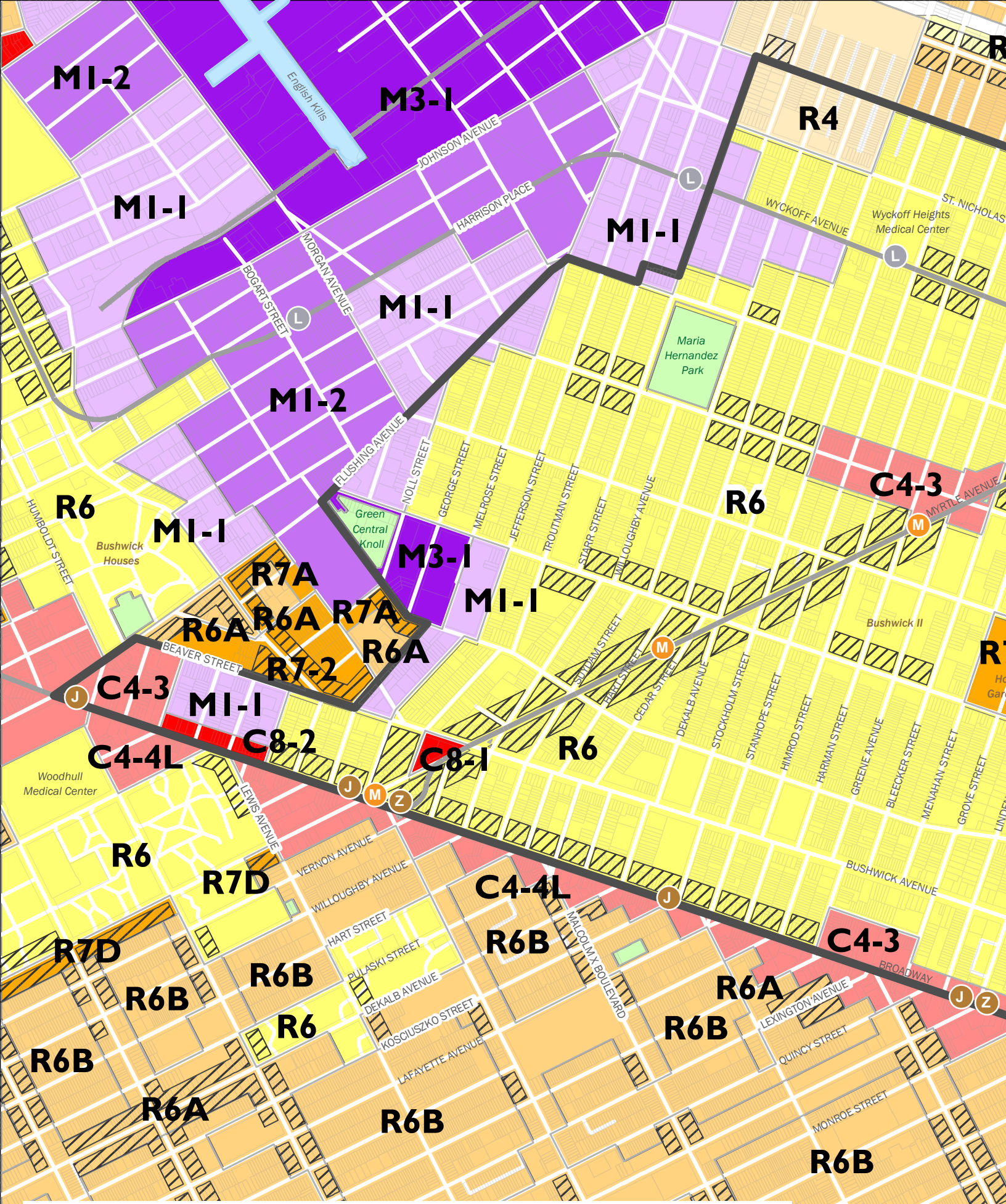

# EXISTING ZONING MAP

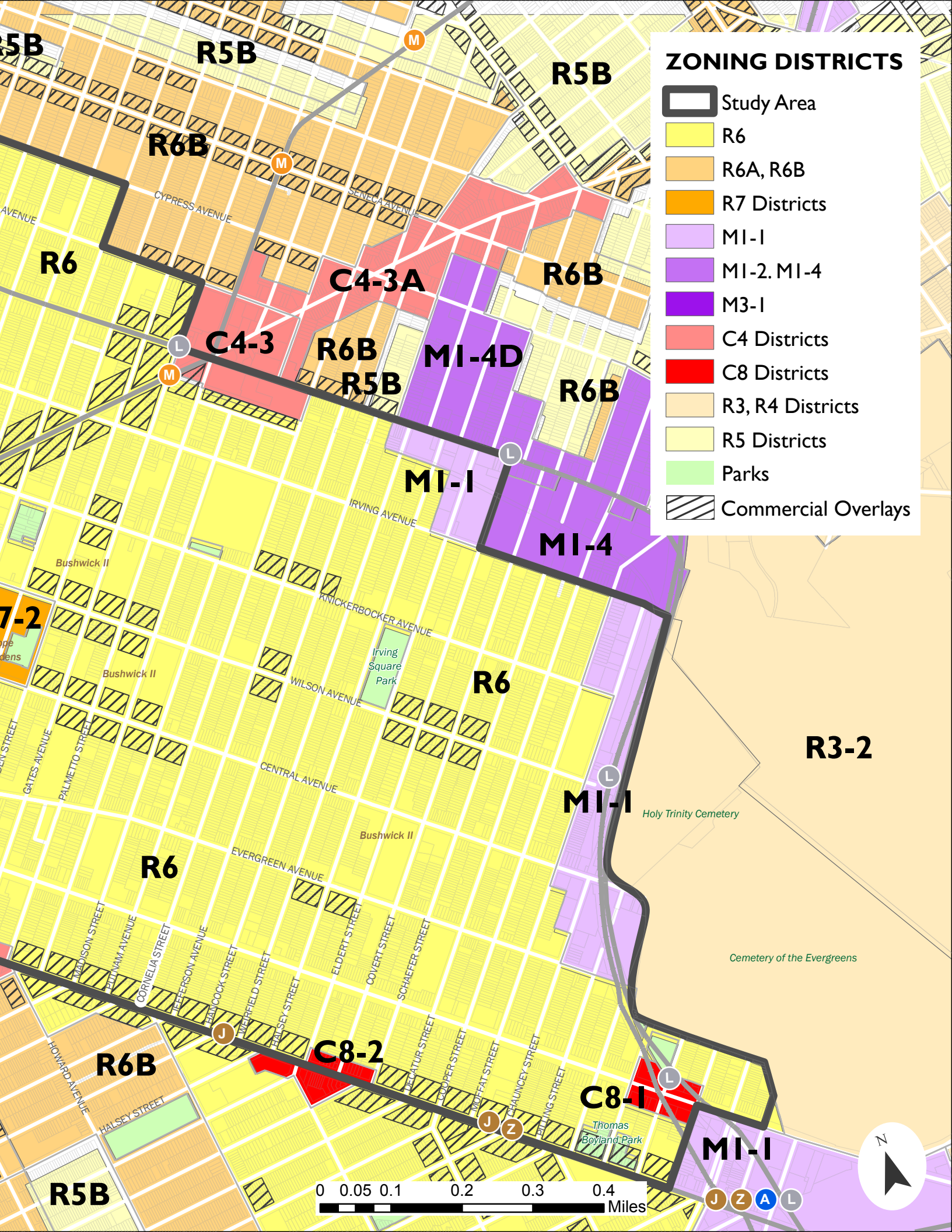



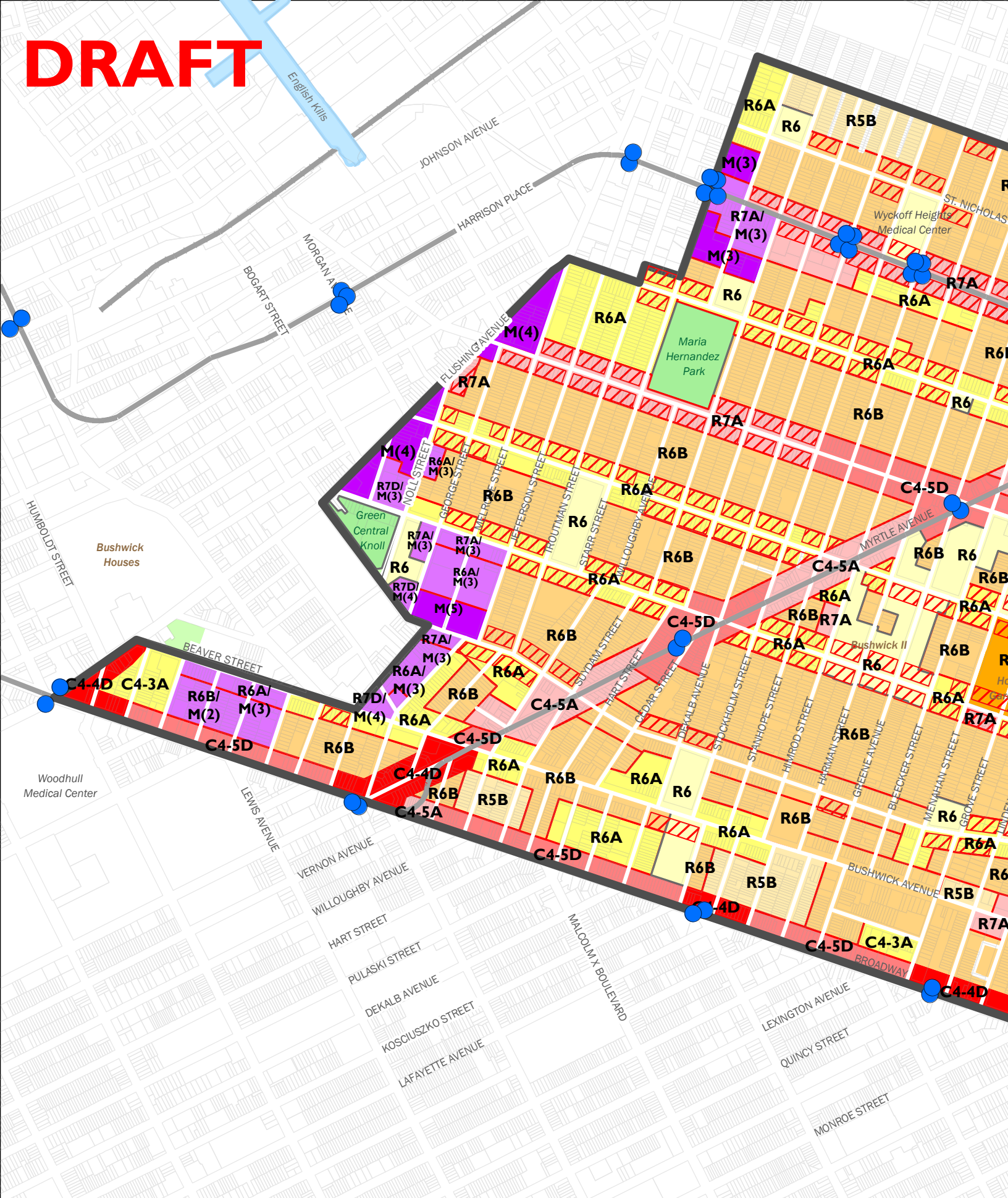















**DRAFT**



**BUSHWICK *DRAFT* ZONING PRO**



# ZONING DISTRICTS

-  Study Area
-  R5B
-  R6B
-  R6A
-  C4-3A
-  R6
-  R7A
-  C4-5A
-  C4-5D
-  R7-2
-  C4-4D
-  MI-1, MI-2
-  MX
-  Mid-Density M
-  Parks
-  Proposed District
-  Existing District
-  Subway entrances
-  Proposed Overlays

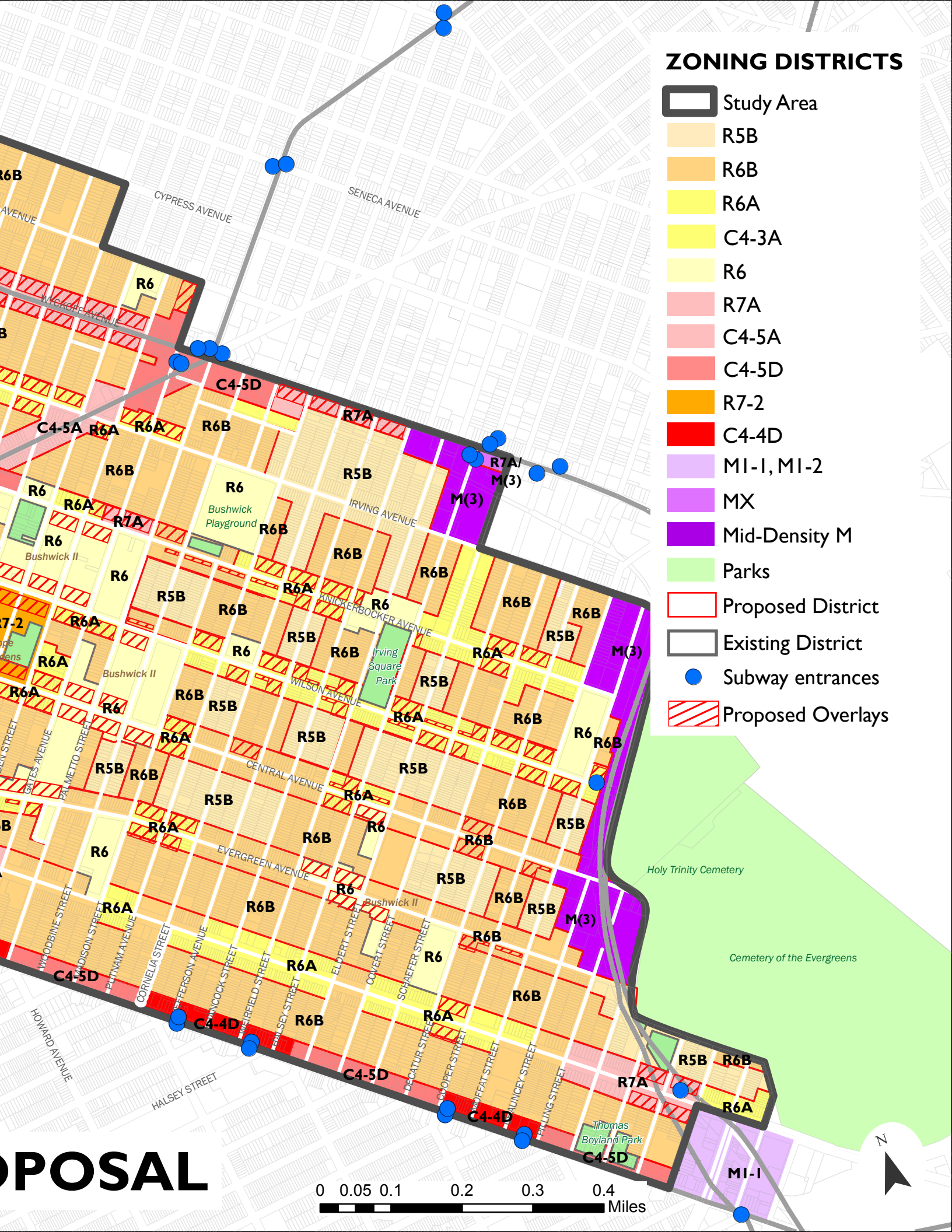

**PROPOSAL**

0 0.05 0.1 0.2 0.3 0.4 Miles





# Neighborhood Planning Process and Next Steps

## **Process: 2014 to 2019**

Since 2014, members of the Bushwick Community Plan Steering and Sub-committees and Community Board 4, participants at public town hall events, and City agency representatives, worked together towards the development of shared goals and strategies for the Bushwick neighborhood. This culminated in the release of the Bushwick Community Plan in September of 2018 which articulated the BCP members' goals and recommendations. The 2018 BCP informed a large part of this Neighborhood Plan Update document, serving as a roadmap for the City and its neighborhood partners as they work to implement a cohesive vision for a thriving and inclusive Bushwick with strategies to: preserve and create affordable housing, channel housing growth to appropriate locations, promote the growth of jobs, businesses, and local services, and identify neighborhood investment opportunities.

## Next Steps

This draft area-wide Plan will be refined through ongoing outreach and discussion with community stakeholders to develop a final neighborhood plan over the coming year. The Plan will work to promote shared goals, identify resources for targeted investments in neighborhood infrastructure and programming, and advance zoning strategies. See next steps below.

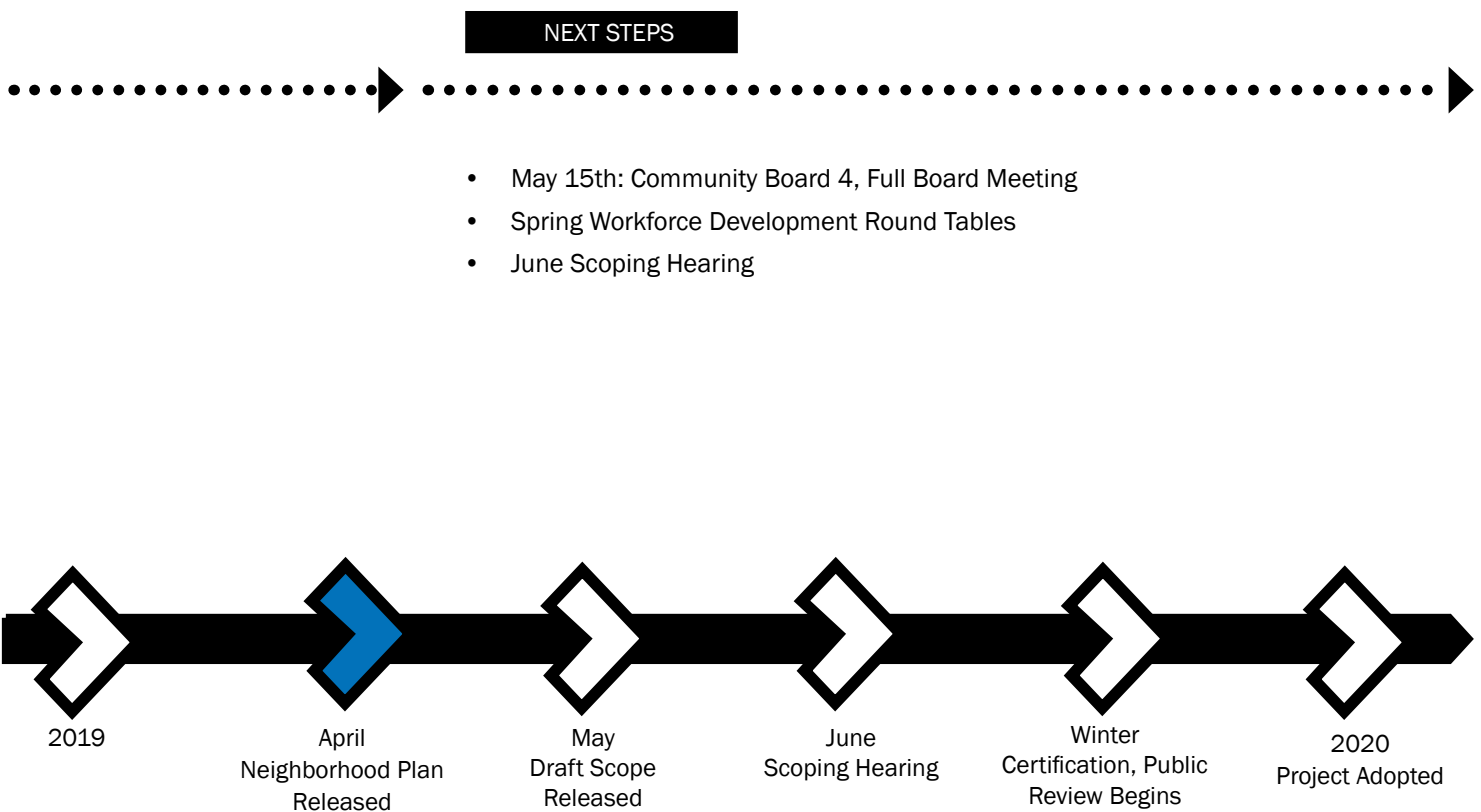

*This timeline reflects the current schedule and is tentative and subject to change*

## How to Get Involved

We urge neighborhood residents, area workers and business owners, and other people interested in planning how Bushwick should grow to get involved. There will be upcoming public events scheduled to gather feedback on the draft plan, and you can follow along with the Plan's next steps online at:

[Nyc.gov/bushwickneighborhoodplan](https://nyc.gov/bushwickneighborhoodplan)

And we know that sometimes great ideas can't wait, so in the interim, you can email your thoughts and comments to:

[bushwickneighborhoodplan@planning.nyc.gov](mailto:bushwickneighborhoodplan@planning.nyc.gov)

## Thank you!

Thank you to all the Bushwick residents, organizations, and stakeholders who have participated in this planning process and shared their time, input, and a commitment to working towards a thriving and inclusive future for Bushwick. Your engagement is essential to the success of this process. The City looks forward to continuing the discussion about these strategies with Bushwick stakeholders.



*Urban Design Workshop*