



THE CITY RECORD

Official Journal of The City of New York

THE CITY RECORD U.S.P.S. 0114-660
Printed on paper containing 30% post-consumer material

VOLUME CXLIII NUMBER 198

THURSDAY, OCTOBER 13, 2016

Price: \$4.00

TABLE OF CONTENTS

PUBLIC HEARINGS AND MEETINGS

Borough President - Manhattan	4329
Borough President - Queens	4329
City Council	4329
City Planning Commission	4333
Community Boards	4333
Design Commission	4334
Franchise and Concession Review Committee	4335
Housing Authority	4335
Independent Budget Office	4335
Landmarks Preservation Commission	4335
Office of Management and Budget	4337
Transportation	4337

COURT NOTICES

Supreme Court	4339
<i>Kings County</i>	4339
<i>Richmond County</i>	4340
<i>Court Notice Maps</i>	4353

PROPERTY DISPOSITION

Citywide Administrative Services	4340
<i>Office of Citywide Procurement</i>	4340
Police	4341

PROCUREMENT

Administration for Children's Services	4341
Administrative Trials and Hearings	4341
<i>Agency Chief Contracting Officer</i>	4341
Brooklyn Navy Yard Development Corporation	4342
<i>Technology</i>	4342
Buildings	4342
<i>Contracts</i>	4342

City University	4342
<i>LaGuardia Community College</i>	4342
Citywide Administrative Services	4342
<i>Office of Citywide Procurement</i>	4342
Design and Construction	4343
<i>Agency Chief Contracting Officer</i>	4343
<i>Professional Contracts</i>	4343
Environmental Protection	4343
<i>Wastewater Treatment</i>	4343
Finance	4343
<i>Agency Chief Contracting Office</i>	4343
Health and Mental Hygiene	4343
<i>Office of External Affairs</i>	4343
Housing Authority	4343
<i>Supply Management</i>	4343
Housing Preservation and Development	4344
<i>Maintenance</i>	4344
Human Resources Administration	4344
<i>Office of Contracts</i>	4344
Information Technology and	
Telecommunications	4344
Mayor's Office of Criminal Justice	4344
Parks and Recreation	4345
<i>Revenue</i>	4345
Sanitation	4345
<i>Agency Chief Contracting Officer</i>	4345
Transportation	4346
<i>Traffic</i>	4346

AGENCY RULES

Environmental Protection	4346
--------------------------	------

SPECIAL MATERIALS

City Planning	4347
Housing Preservation and Development	4348
Mayor's Office of Contract Services	4348
Changes in Personnel	4349

THE CITY RECORD

BILL DE BLASIO

Mayor

LISETTE CAMILO

Commissioner, Department of Citywide
Administrative Services

ELI BLACHMAN

Editor, The City Record

Published Monday through Friday except legal holidays by the New York City Department of Citywide Administrative Services under Authority of Section 1066 of the New York City Charter.

Subscription \$500 a year, \$4.00 daily (\$5.00 by mail). Periodicals Postage Paid at New York, N.Y. POSTMASTER: Send address changes to THE CITY RECORD, 1 Centre Street, 17th Floor, New York, N.Y. 10007-1602

Editorial Office/Subscription Changes:
The City Record, 1 Centre Street, 17th Floor, New York, N.Y. 10007-1602 (212) 386-0055

Visit The New City Record Online (CROL) at www.nyc.gov/cityrecord for a searchable database of all notices published in the City Record.

PUBLIC HEARINGS AND MEETINGS

See Also: Procurement; Agency Rules

BOROUGH PRESIDENT - MANHATTAN

MEETING

The Manhattan Borough Board will meet Thursday, October 20, 2016, at 8:30 A.M., in the Office of Manhattan Borough President, 1 Centre Street, 19th Floor South, New York, NY 10007.



o13-20

BOROUGH PRESIDENT - QUEENS

MEETING

The Queens Borough Board will meet Wednesday, October 19, 2016, at 5:30 P.M., in the Queens Borough President Conference Room, 120-55 Queens Boulevard, 2nd Floor, Kew Gardens, NY 11424.

Accessibility questions: Jeong-ah Choi, (718) 286-2860, jchoi@queensbp.org, by: Monday, October 17, 2016, 2:00 P.M.



o13-19

CITY COUNCIL

PUBLIC HEARINGS

NOTICE IS HEREBY GIVEN that the Council has scheduled the following public hearings on the matters indicated below:

The Subcommittee on Zoning and Franchises will hold a public hearing on the following matters in the Council Committee Room, 16th Floor, 250 Broadway, New York City, NY 10007, commencing at 9:30 A.M., Wednesday, October 19, 2016:

REEF

QUEENS - CB 6

20175051 TCQ

Application pursuant to Section 20-226 of the Administrative Code of the City of New York, concerning the petition of 10802 72nd Rest, LLC, d/b/a Reef, for a new revocable consent to establish, maintain and operate an unenclosed sidewalk café, located at 108-02 72nd Avenue.

HAPPY COOKING BISTRO

MANHATTAN - CB 2

20165243 TCM

Application pursuant to Section 20-225 of the Administrative Code of the City of New York, concerning the petition of Happy Cooking

Bistro, LLC, d/b/a Happy Cooking Bistro, for a new revocable consent to establish, maintain and operate an enclosed sidewalk café, located at 322 Spring Street.

95 HORATIO STREET

MANHATTAN - CB 2 M 840260 (E) ZMM

Application submitted by 95-97 Horatio LLC for the modification of Restrictive Declaration D-93, which was previously approved in connection with an application for a Zoning Map amendment (C 840260 ZMM), to allow uses permitted by the underlying C6-2A District, except for nightclub uses, in the 4,700-square-foot ground floor space, located at 95 Horatio Street (Block 643, Lot 1), in a C6-2A District.

LAMBERT HOUSES REDEVELOPMENT

BRONX - CB 6 C 160285 ZMX

Application submitted by the NYC Department of Housing Preservation and Development and Phipps Houses pursuant to Sections 197-c and 201 of the New York City Charter for the amendment of the Zoning Map, Section No. 3d:

- 1. changing from an R7-1 District to an R8 District property bounded by:
a. a line 230 feet southeasterly of Vyse Avenue, East 180th Street, a line perpendicular to the northeasterly street line of East 180th Street distant 335 feet northwesterly (as measured along the streetline) from the point of intersection of the northeasterly street line of East 180th Street and the northwesterly street line of Boston Road, a line 100 feet northeasterly of East 180th Street, 100 feet northwesterly of Boston Road, Bronx Park South, Boston Road, East 180th Street, a line 280 feet southeasterly of Boston Road, 100 feet southwesterly of East 180th Street, 100 feet southeasterly of Boston Road, a line 140 feet northeasterly of East 179th Street, Boston Road, East 179th Street, 100 feet northwesterly of Boston Road, and 120 feet southwesterly of East 180th Street; and
b. Boston Road, East 179th Street, the easterly street line of former Bronx Street, East Tremont Avenue, and West Farms Road; and
2. establishing within a proposed R8 District a C1-4 District bounded by a line 100 feet northwesterly of Boston Road, Bronx Park South, Boston Road, and East 179th Street.

LAMBERT HOUSES REDEVELOPMENT

BRONX - CB 6 C 160286 HAX

Application submitted by the NYC Department of Housing Preservation and Development (HPD) and Phipps Houses.

- 1) Pursuant to Article 16 of the General Municipal Law of New York State for:
a) The designation of property, located at Boston Road (Block 3139, Lot 50), as an Urban Development Action Area; and
b) an Urban Development Action Area Project for such area; and
2) pursuant to Section 197-c of the New York City Charter for the disposition of such property to a developer to be selected by HPD;

to facilitate a mixed use development containing approximately 1,665 affordable residential units, approximately 86,608 square feet of retail space and approximately 110 accessory parking spaces in Community District 6.

LAMBERT HOUSES REDEVELOPMENT

BRONX - CB 6 N 160288 ZRX

Application submitted by the Department of Housing Preservation and Development and Phipps Houses, pursuant to Section 201 of the New York City Charter, for an amendment of the Zoning Resolution of the City of New York, modifying Article VII, Chapter 8 relating to provisions for Location of Buildings, Distribution of Bulk and Open Space and Modification of Height and Setbacks in Community District 6.

Matter underlined is new, to be added;
Matter in strikeout is to be deleted;
Matter within # # is defined in Section 12-10;
* * * indicates where unchanged text appears in the Zoning Resolution

* * *

Article VII: ADMINISTRATION
Chapter 8 - Special Regulations Applying to Large-Scale Residential Developments

* * *

78-30
BULK REGULATIONS

78-31
Location of Buildings, Distribution of Bulk and Open Space and Modification of Height and Setbacks

(a) General provisions

For the purposes of this Section, the term "periphery" shall mean any #street line# bounding a #large-scale residential development# or any #lot line# abutting a #zoning lot# that is not part of the #large-scale residential development#. The term "wholly within" shall therefore mean any area of the #large-scale residential development# which is not within the area designated as "periphery." However, in R3-2 Districts, R4 Districts except R4A, R4-1 and R4B Districts, or R5 Districts except R5B Districts, the "periphery" shall also include all portions of a #large-scale residential development# within 100 feet of a peripheral #street line# or within 30 feet of any other peripheral #lot line#, except for portions directly opposite:

- (1) an area of at least 1.5 acres in a #Residence District# that is either vacant or #land with minor improvements#; or
(2) a #large-scale residential development developed# pursuant to the provisions of paragraph (b) of this Section; or
(3) a #Commercial# or a #Manufacturing District#.

All #buildings or other structures# in the periphery of a #large-scale residential development# shall comply with the height and setback regulations of Article II, Chapter 3, except as otherwise provided in this Section.

Special provisions applying to #large-scale residential developments# in R3, R4 or R5 Districts are set forth in paragraphs (b) and (c) of this Section. The provisions of paragraph (b) shall apply to any #large-scale residential development# in R3-2 Districts, R4 Districts except R4A, R4-1 and R4B Districts, or R5 Districts except R5B Districts. The provisions of paragraph (c) shall apply only to #large-scale residential developments# in all R3, R4 or R5 Districts that utilize the bonus provisions of Section 78-32 through 78-35, inclusive.

(b) Alternate height and setback regulations for certain districts

In R3-2 Districts, R4 Districts except R4A, R4-1 and R4B Districts, or R5 Districts except R5B Districts, #buildings or other structures#, or portions thereof, "wholly within" a #large-scale residential development# may use the alternate height and setback regulations set forth in paragraphs (b)(1) through (b)(3) of this Section.

- (1) In R3-2 Districts, the height and setback regulations applicable to R4 Districts, except R4A and R4B Districts, may be used.
(2) In R4 Districts, no portion of any #building or other structure#, including the apex of a roof, shall penetrate a plane 35 feet in height above the #base plane#.
(3) In R5 Districts, no portion of any #building or other structure#, including the apex of a pitched roof, shall penetrate a plane 40 feet in height above the #base plane#.
(c) Alternate #floor area# and #open space# regulations in R3, R4 or R5 Districts

In #large-scale residential developments# that utilize the bonus provisions of this Chapter, the #floor area ratio# and the #open space ratio# controls set forth in the following table shall apply in lieu of the #floor area ratio# and #lot coverage# controls of Article II, Chapter 3.

Table with 3 columns: District, #Open Space Ratio#, #Floor Area Ratio#. Rows for R3, R4, R5.

* The #floor area ratio# in the table may be increased by up to 20 percent provided that any such increase in #floor area# is located under a sloping roof which rises at least 3 1/2 inches in vertical distance per each foot of horizontal distance and the structural headroom of such #floor area# is between five and eight feet. Any such additional #floor area# under a sloped roof shall not be used to compute the #open space ratio#

- (d) Authorizations may be granted for #buildings# to be located, #bulk# and #open space# distributed, and height and setback modified, in accordance with the provisions of this Section.
(e) In R9, R10, C1-8, C1-9, C2-7 or C2-8 Districts, or in C1 or C2 Districts mapped within R9 or R10 Districts, #floor area# bonuses for #public plazas# or #arcades# permitted in accordance with the applicable district regulations shall apply only to a #development# or #enlargement# with 25 percent or less of the total #floor area# of the #building# in #residential use#.
(f) Alternate window to #lot line# regulations for a #zoning lot# directly adjoining a #public park#

In R7-1 and R8 Districts within a #large scale residential development# in Community District 6 in the Borough of the Bronx, the required minimum distance between a #legally required window# and a #lot line#, as set forth in Section 23-86 (Minimum Distance Between Legally Required Windows and Walls or Lot Lines), inclusive, shall not apply where a #legally required window# is fronting upon a #public park# with an area of at least one-half acre.

* * *

LAMBERT HOUSES REDEVELOPMENT

BRONX - CB 6 N 160289 ZRX

Application submitted by the NYC Department of Housing Preservation and Development and Phipps Houses pursuant to Section 201 of the New York City Charter, for an amendment of the Zoning Resolution of the City of New York, to establish a Mandatory Inclusionary Housing area, Borough of the Bronx, Community District 6.

Matter in underline is new, to be added; Matter in strikethrough is to be deleted; Matter within # # is defined in Section 12-10; * * * indicates where unchanged text appears in the Zoning Resolution

* * *

APPENDIX F Inclusionary Housing Designated Areas and Mandatory Inclusionary Housing Areas

* * *

THE BRONX

* * *

The Bronx Community District 6

In the R7-1, R7A, R7D, R7X, R8, R8A and R8X Districts within the areas shown on the following Maps 1, 2, 3, 4, and 5 and 6:

* * *

Map 6 - [date of adoption]

[PROPOSED MAP]

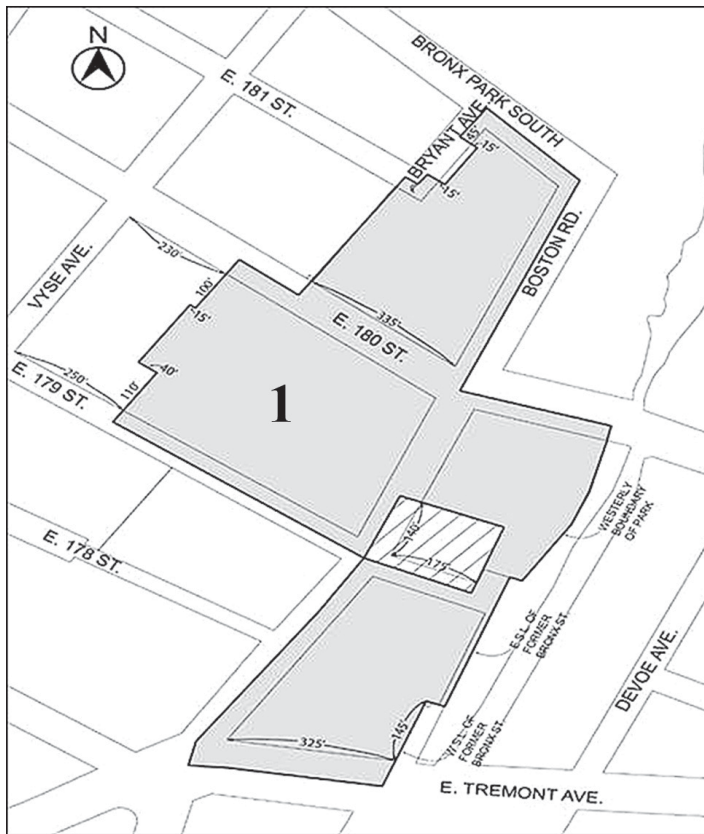

Mandatory Inclusionary Housing area see Section 23-154(d)(3) Area 1 [date of adoption] — MIH Program Option 1 Excluded area

Portion of Community District 6, The Bronx

* * *

LAMBERT HOUSES REDEVELOPMENT

BRONX - CB 6 C 160290 ZSX

Application submitted by the New York City Department of Housing Preservation and Development and Phipps Houses pursuant to Sections 197-c and 201 of the New York City Charter for the grant of a special permit to Section 78-312(d) of the Zoning Resolution to modify the height and setback requirements of Section 23-632 on the periphery of a large-scale residential development, in connection with a proposed mixed-use development within a proposed large-scale residential development, on property generally bounded by Bronx Park South, Boston Road, East 180th Street, the Bronx River, East Tremont Avenue, Boston Road, East 179th Street, a line approximately 170 feet southeasterly of Boston Road, a line approximately 240 feet southwesterly of East 180th Street, Boston Road, East 179th Street, a line approximately 230 feet southeasterly of Vyse Avenue, East 180th Street, the northwesterly street line of former Bryant Avenue, East 181st Street, and Bryant Avenue (Block 3132, Lot 1, Block 3138, Lot 1, Block 3139, Lots 1, 19 & 50, and Block 3140, Lot 7), in R7-1, R7-1/C1-4, R8, and R8/C1-4 Districts.

LAMBERT HOUSES REDEVELOPMENT

BRONX - CB 6 C 160218 MMX

Application submitted by The New York City Department of Housing Preservation and Development and Phipps Houses, pursuant to Sections 197-c and 199 of the New York City Charter, and Section 5-430 et seq. of the New York City Administrative Code for an amendment to the City Map involving:

- the narrowing by elimination, discontinuance and closing of a portion of East Tremont Avenue from Boston Road to East Tremont Avenue; and the adjustment of grades and block dimensions necessitated thereby;

including authorization for any acquisition or disposition of real property related thereto, in The Borough of The Bronx, Community District 6, in accordance with Map No. 13137 dated April 27, 2016 and signed by the Borough President.

LAMBERT HOUSES REDEVELOPMENT

BRONX - CB 6 C 160307 ZSX

Application submitted by the New York City Department of Housing Preservation and Development and Phipps Houses pursuant to Sections 197-c and 201 of the New York City Charter for the grant of a special permit to Section 78-312(d) of the Zoning Resolution to modify the height and setback requirements of Section 23-632 on the periphery of a large-scale residential development, in connection with a proposed modification of an existing large-scale residential development, on property generally bounded by East 179th Street, Boston Road, Bryant Avenue, a line approximately 110 feet southwesterly of East Tremont Avenue, a line approximately 67 feet southeasterly of Bryant Avenue, a line approximately 80 feet southwesterly of East Tremont Avenue, a line approximately 140 feet southeasterly of Bryant Avenue, East Tremont Avenue, and a line approximately 260 feet southeasterly of Vyse Avenue, (Block 3005, Lot 65, Block 3130, Lots 20 & 100, Block 3131, Lot 20, and Block 3136, Lots 1, 20 & 101), in an R7-1 District.

1614 WILLIAMSBRIDGE ROAD

BRONX - CB 11 C 160332 ZMX

Application submitted by Dominick Calderoni, Fred T. Santucci Jr. & Jeffrey D. Klein pursuant to Sections 197-c and 201 of the New York City Charter, for an amendment of the Zoning Map, Section No. 4b:

- establishing within an existing R4 District a C2-2 District bounded by Pierce Avenue, a line 150 feet southwesterly of Yates Avenue, a line 75 feet southeasterly of Pierce Avenue, Williamsbridge Road, a line 50 feet southeasterly of Pierce Avenue, and a line 50 feet northeasterly of Tomlinson Avenue; and
- establishing within an existing R4A District a C2-2 District bounded by a line 100 feet northwesterly of Pierce Avenue, Williamsbridge Road, a line 225 feet northwesterly of Pierce Avenue, a line 110 feet southwesterly of Yates Avenue, Pierce Avenue, and a line 50 feet northeasterly of Tomlinson Avenue.

CONCOURSE VILLAGE WEST REZONING

BRONX - CB 4 C 150312 ZMX

Application submitted by the Upper Manhattan Development Corporation, pursuant to Section 197-c and 201 of the New York City Charter for the amendment of the Zoning Map, Section No. 6a:

- changing from a C8-3 District to an R7D District property bounded by a line 100 feet northwesterly of Concourse Village West, East 156th Street, Concourse Village West, East 153rd Street, the centerline of the easterly portion of Grand Concourse, and a line 525 feet southwesterly of East 156th Street;
- changing from a C8-3 District to an R8 District property bounded by the centerline of the easterly portion of Grand Concourse, a line 450 feet southwesterly of East 156th Street, a line 100 feet

northwesterly of Concourse Village West, and a line 525 feet southwesterly of East 156th Street; and

- 3. establishing within the proposed R7D District a C1-4 District bounded by a line 100 feet northwesterly of Concourse Village West, East 156th Street, Concourse Village West, and a line 200 feet southwesterly of East 156th Street.

CONCOURSE VILLAGE WEST REZONING

BRONX - CB 4 N 150313 ZRX

Application submitted by the Upper Manhattan Development Corporation pursuant to Sections 201 of the New York City Charter, for an amendment of the Zoning Resolution of the City of New York, to establish a Mandatory Inclusionary Housing area, Borough of the Bronx, Community District 4.

Matter in underline is new, to be added;

Matter in ~~strikeout~~ is to be deleted;

Matter within # # is defined in Section 12-10;

* * * indicates where unchanged text appears in the Zoning Resolution

* * *

APPENDIX F

Inclusionary Housing Designated Areas and Mandatory Inclusionary Housing Areas

* * *

The Bronx Community District 4

In portions of the #Special Grand Concourse Preservation District# and in the R7A, R7D, R8, R8A and R9D Districts within the areas shown on the following Map 1:

[EXISTING MAP]

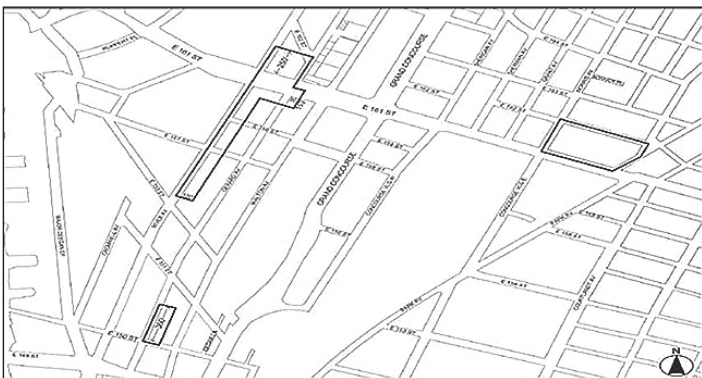

[PROPOSED MAP]



 Inclusionary Housing designated area

 Mandatory Inclusionary Housing area see Section 23-154(d) (3) Area 1 [date of adoption] — MIH Program Option 2

Portion of Community District 4, The Bronx

* * *

1932 BRYANT AVENUE

BRONX - CB 6 C 160365 ZMX

Application submitted by Second Farms Neighborhood, HFDC pursuant to Sections 197-c and 201 of the New York City Charter for the grant of a special permit pursuant Zoning Map, Section No. 3d:

- 1. changing from an R7-1 District to an R8 District property bounded by Bryant Avenue, a line 80 feet southwesterly of East Tremont Avenue, a line perpendicular to the southwesterly street line of East Tremont Avenue distant 125 feet northwesterly (as measured along the street line) from the point of intersection of the southwesterly street line of East Tremont Avenue and the northwesterly street line of Boston Road, East Tremont Avenue, and Boston Road; and
- 1. establishing within the proposed R8 District a C2-4 District bounded by a line 100 feet northwesterly of Boston Road, a line 80 feet southwesterly of East Tremont Avenue, a line perpendicular to the southwesterly street line of East Tremont Avenue distant 125 feet northwesterly (as measured along the street line) from the point of intersection of the southwesterly street line of East Tremont Avenue and the northwesterly street line of Boston Road, East Tremont Avenue, Boston Road, and Bryant Avenue;

Borough of the Bronx, Community District 6, as shown on a diagram (for illustrative purposes only) dated June 6, 2016, and subject to the conditions of the CEQR Declaration E-388.

1932 BRYANT AVENUE

BRONX - CB 6 N 160366 ZRX

Application submitted by the Second Farms Neighborhood HFDC, pursuant to Section 201 of the New York City Charter, for an amendment of the Zoning Resolution of the City of New York, modifying Appendix F for the purpose of establishing a Mandatory Inclusionary Housing area, Community District 6, Borough of the Bronx.

Matter in underline is new, to be added;

Matter in ~~strikeout~~ is to be deleted;

Matter within # # is defined in Section 12-10;

* * * indicates where unchanged text appears in the Zoning Resolution

* * *

APPENDIX F

Inclusionary Housing Designated Areas and Mandatory Inclusionary Housing Areas

* * *

THE BRONX

* * *

Bronx Community District 6

In the R7A, R7D, R7X, R8, R8A and R8X Districts within the areas shown on the following Maps 1, 2, 3, 4, and 5 and 6:

* * *

Map 6 – [date of adoption]

[PROPOSED MAP]

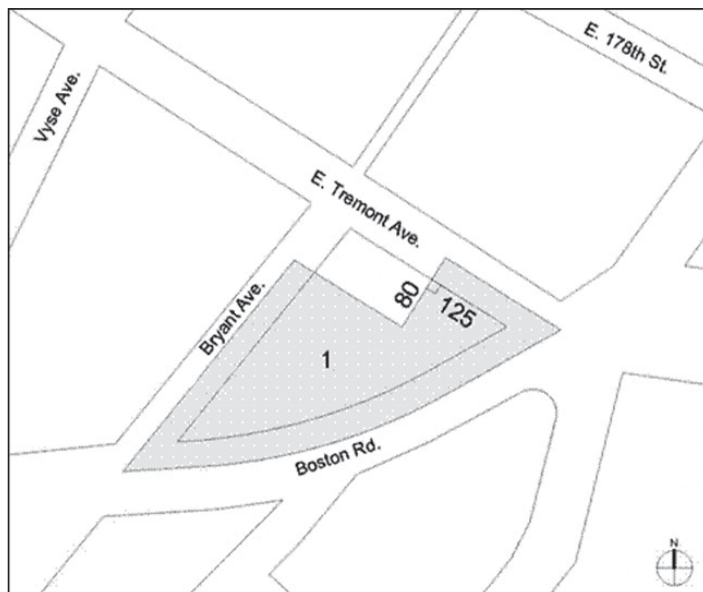

 Mandatory Inclusionary Housing area see Section 23-154(d)(3) Area 1 [date of adoption] — MIH Program Option 1 and Option 2

Portion of Community District 6, The Bronx

property, located at 72-42 60th Lane, for use as storage and related program spaces.

o13-19

PUBLIC NOTICE IS HEREBY GIVEN that the following matters have been scheduled for public hearing by Community Board:

BOROUGH OF BROOKLYN

COMMUNITY BOARD NO. 10 Monday, October 17, 2016 7:15 P.M., Fort Hamilton Senior Center, 9941 Fort Hamilton Parkway, Brooklyn, NY.

Public Hearing: Draft of Capital and Expense budget priorities for fiscal year 2018.

o11-17

PUBLIC NOTICE IS HEREBY GIVEN, that the following matters have been scheduled for public hearing by Community Board:

BOROUGH OF THE BRONX

COMMUNITY BOARD NO. 10 Thursday, October 13, 2016, 7:30 P.M., Bronx Community Board 10 Office, 3165 East Tremont Avenue, Bronx, NY.

A public hearing regarding Fiscal Year 2018 Budget Priorities.

o6-13

PUBLIC NOTICE IS HEREBY GIVEN that the following matters have been scheduled for public hearing by Community Board:

BOROUGH OF BROOKLYN

COMMUNITY BOARD NO. 18 Wednesday, October 19, 2016, 7:00 P.M., 1097 Bergen Avenue, Brooklyn, NY.

IN THE MATTER OF The Capital & Expense Budget Submissions for Fiscal Year 2018 - In preparation for the FY 2018 Capital and Expense Budget submissions. Civic and block associations, and the community-at-large, are invited to submit budget requests for consideration by the Community Board for inclusion in the Capital & Expense Budget Submissions for Fiscal Year 2018.

o13-19

PUBLIC NOTICE IS HEREBY GIVEN that the following matters have been scheduled for public hearing by Community Board:

BOROUGH OF BROOKLYN

COMMUNITY BOARD NO. 17 Wednesday, October 19, 2016, 7:00 P.M., Top Civic Center, 1100 Utica Avenue, Brooklyn, NY.

STATEMENT OF EXPENSE AND CAPITAL BUDGET PRIORITIES AND OF COMMUNITY DISTRICT NEEDS TO BE SUBMITTED BY COMMUNITY BOARD 17 FOR FISCAL YEAR 2018.

IN THE MATTER OF: Two statements to be submitted annually by Community Board 17 to the Mayor, pursuant to Sections 230 and 2800(d) (10&11) of the New York City Charter, of Expense Budget and Capital Budget priorities and of Community District Needs.

o13-19

DESIGN COMMISSION

MEETING

Agenda

Monday, October 17, 2016

The Committee Meeting is scheduled to begin at 9:30 A.M.

Public Meeting

11:00 A.M. Consent Items

- 25907: Reconstruction of a plaza, Kings Plaza Shopping Center, 5100 Kings Plaza, Brooklyn. (Preliminary and Final) (CC 46, CB 18) DCAS
- 25908: Construction of a portion of the Brooklyn Waterfront Greenway from Owl's Head Park at Wakeman Place to 2nd Avenue and 58th Street, Brooklyn. (Preliminary and Final) (CC 38, 43, CB 7 & 10) DDC/DOT
- 25909: Construction of a prototypical planted median, Atlantic Avenue from Georgia Avenue to Conduit Boulevard, Brooklyn. (Preliminary and Final) (CC 37, CB 5) DDC/DOT
- 25910: Reconstruction of a plaza, Flatbush Avenue at Eighth

- Avenue, Brooklyn. (Final) (CC 35, CB 6) DDC/DOT
- 25911: Installation of *Para Roberto* by Melissa Calderon, Roberto Clemente Plaza, Third Avenue, East 147th Street, East 149th Street, and Willis Avenue, Bronx. (Conceptual) (CC 8, CB 1) DDC/DOT/DCLA%
- 25912: Rehabilitation of Building J (Kids Powerhouse Discovery Center), 1 East 150th Street, Mill Pond Park (formerly Bronx Terminal Market), Bronx. (Preliminary and Final) (CC 8, CB 4) DDC/DPR
- 25913: Installation of rooftop equipment, Bloomingdale Branch Library, 150 West 100th Street, Manhattan. (Preliminary and Final) (CC 8, CB 7) DDC/NYPL
- 25914: Reconstruction of Bloomingdale Playground, Amsterdam Avenue between West 104th Street and West 105th Street, Manhattan. (Preliminary) (CC 7, CB 7) DPR
- 25915: Stabilization of the shoreline adjacent to Shaft 18, Kensico Reservoir, Westlake Drive, Valhalla, Mount Pleasant, Westchester County. (Final) DEP
- 25916: Construction of a stoop, 360 West 122nd Street, Manhattan. (Preliminary and Final) (CC 9, CB 10) DOT
- 25917: Reconstruction of a sidewalk, 420 Lexington Avenue, Lexington Avenue between 43rd Street and 44th Street, Manhattan. (Preliminary and Final) (CC 4, CB 5) DOT
- 25918: Reconstruction of a playground, Battery Park, State Street, Minuit Plaza, and South Street, Manhattan. (Preliminary) (CC 1, CB 1) DPR
- 25919: Reconstruction of Jacob Javits Playground, Fort Tryon Park, Margaret Corbin Plaza, Cabrini Boulevard and Fort Washington Avenue, Manhattan. (Preliminary) (CC 10, CB 12) DPR
- 25920: Reconstruction of a ballfield, Patterson Playground, adjacent to P.S. 18, College Avenue between East 145th Street and East 148th Street, Bronx. (Preliminary and Final) (CC 8, CB 1) DPR
- 25921: Construction of a playground, Van Cortlandt Park, Mosholu Avenue and Broadway, Bronx. (Final) (CC 11, CB 8) DPR
- 25922: Construction of ADA ramp and adjacent site work, Poe Cottage, Poe Park, Grand Concourse and East Kingsbridge Road, Bronx. (Final) (CC 15, CB 7) DPR
- 25923: Reconstruction of Edenwald Playground, Schieffelin Avenue between East 225th Street and East 229th Street, Bronx. (Final) (CC 12, CB 12) DPR
- 25924: Reconstruction of Michaelis-Bayswater Park, Bay 32nd Street and Dwight Avenue, Queens. (Final) (CC 31, CB 14) DPR
- 25925: Reconstruction of Aqueduct Walk, Phase II, Aqueduct Avenue between West 181st Street and West Burnside Avenue, Bronx. (Final) (CC 14, CB 5) DPR/DOT
- 25926: Installation of condensers, 625 Atlantic Avenue, Brooklyn. (Preliminary and Final) (CC 35, CB 2) EDC
- 25927: Reconstruction of Pier C, Phase I, Brooklyn Navy Yard Industrial Park, 63 Flushing Avenue, Brooklyn. (Preliminary and Final) (CC 33, CB 2) EDC
- 25928: Design of prototypical ferry service landings and canopies for installation citywide. (Final) EDC
- 25929: Reconstruction of the landscape to accommodate citywide ferry service, including the installation of electrical equipment, fencing and access gate, Beach 108th Street and Beach Channel Drive, Queens. (Preliminary) (CC 32, CB 14)
- 25930: Reconstruction of the landscape to accommodate citywide ferry service, including the installation of electrical equipment, fencing and access gate, Hallets Cove, East River between Hallets Point Playground and Goodwill Park, Queens. (Preliminary) (CC 22, CB 1)
- 25931: Reconstruction of the landscape to accommodate citywide ferry service, including the installation of electrical equipment, fencing and access gate, East River between East 20th Street and FDR Drive, Manhattan. (Preliminary) (CC 4, CB 6)
- 25932: Reconstruction of the landscape to accommodate citywide ferry service, including the installation of electrical equipment, fencing and access gate, Bay Ridge-American Veterans Memorial Pier, Bay Ridge Avenue and New York Bay, Brooklyn. (Preliminary) (CC 43, CB 10)
- 25933: Installation of an emergency generator, Engine Company 275, 111-36 Merrick Boulevard, Jamaica, Queens. (Preliminary and Final) (CC 27, CB 8) FDNY

- 25934: Installation of an emergency generator, Engine Company 52, 4550 Henry Hudson Parkway East, Bronx. (Preliminary and Final) (CC 11, CB 8) FDNY
- 25935: Installation of an emergency generator, Engine Company 70, 169 Schofield Street, Bronx. (Preliminary and Final) (CC 13, CB 10) FDNY
- 25936: Installation of rooftop solar thermal equipment and supply and return piping, Engine Company 44, 221 East 75th Street, Manhattan. (Preliminary and Final) (CC 4, CB 8) FDNY

Public Hearing

11:05 A.M.

- 25937: Installation of a prototypical newsstand, 418 11th Avenue, southeast corner of 11th Avenue and West 36th Street, Manhattan. (Preliminary and Final) (CC 33, CB 4) DCA/DOT

11:25 A.M.

- 25938: Installation of a prototypical newsstand, 1362 Jerome Avenue, southeast corner Jerome Avenue and Elliot Place, Bronx. (Preliminary and Final) (CC 16, CB 4) DCA/DOT

11:45 A.M.

- 25939: Reconstruction of bus stops and adjacent site work, Riverside Park, Riverside Drive from West 79th Street to West 129th Street, Manhattan. (Preliminary) (CC 6 & 7, CB 7 & 9) DPR

12:15 P.M.

- 25940: Reconstruction of the Well House landscape, Prospect Park, 200 Well House Drive, Brooklyn. (Final) (CC 39, CB 6, 7, 8, 9, & 14) DPR/PPA

Design Commission meetings are held in the Conference Room on the Third Floor of City Hall, unless otherwise indicated.

All attendees, including members of the public, are encouraged to arrive at least 45 minutes in advance of the estimated time; those who also plan to testify are encouraged to submit their testimony in writing in advance of the meeting date. Please note that all times are approximate and subject to change without notice.

Please note that items on the consent agenda are not presented. If members of the public wish to testify on a consent agenda item, they should contact the Design Commission immediately, so the project can be rescheduled for a formal presentation at the next appropriate public hearing, per standard procedure.

Do you need assistance to participate in the meeting? If you need a reasonable accommodation of a disability, such as a sign language interpreter, at the meeting, please inform the Public Design Commission three business days (72 hours) in advance of the meeting. The Public Design Commission conference room is wheelchair accessible.

Per Local Law Int 0132-2010, meetings are recorded on digital video and posted online.

Public Design Commission
 City Hall, Third Floor
 Phone: (212) 788-3071
 Fax: (212) 788-3086
www.nyc.gov/designcommission
designcommission@cityhall.nyc.gov



o13

FRANCHISE AND CONCESSION REVIEW COMMITTEE

MEETING

PUBLIC NOTICE IS HEREBY GIVEN that the Franchise and Concession Review Committee will hold a public meeting on Thursday, October 13, 2016, at 2:30 P.M., at 2 Lafayette Street, 14th Floor Conference Room, Borough of Manhattan.

NOTE: Individuals requesting Sign Language Interpreters should contact the Mayor's Office of Contract Services, 253 Broadway, 9th Floor, New York, NY 10007, (212) 788-0010, no later than **SEVEN (7) BUSINESS DAYS PRIOR TO THE PUBLIC MEETING.**

o3-13

HOUSING AUTHORITY

MEETING

The next Board Meeting of the New York City Housing Authority, is scheduled for Wednesday, October 26, 2016, at 10:00 A.M., in the Board Room, on the 12th Floor of 250 Broadway, New York, NY (unless otherwise noted). Copies of the Calendar are available on NYCHA's website, or can be picked up at the Office of the Corporate Secretary, at 250 Broadway, 12th Floor, New York, NY, no earlier than 24 hours before the upcoming Board Meeting. Copies of the Minutes are also available on NYCHA's website or can be picked up at the Office of the Corporate Secretary, no earlier than 3:00 P.M., on the Thursday after the Board Meeting.

Any changes to the schedule will be posted here and on NYCHA's website, at <http://www1.nyc.gov/site/nycha/about/board-calendar.page> to the extent practicable at a reasonable time before the meeting.

The meeting is open to the public. Pre-Registration at least 45 minutes before the scheduled Board Meeting is required by all speakers. Comments are limited to the items on the Calendar. Speaking time will be limited to three minutes. The public comment period will conclude upon all speakers being heard or at the expiration of 30 minutes allotted by law for public comment, whichever occurs first.

Any person requiring a reasonable accommodation in order to participate in the Board Meeting, should contact the Office of the Corporate Secretary by phone at (212) 306-6088 or by email, at corporate.secretary@nycha.nyc.gov, no later than five business days before the Board Meeting.

For additional information, please visit NYCHA's website or contact (212) 306-6088.

Accessibility questions: Office of the Corporate Secretary by phone, at (212) 306-6088, or by email at corporate.secretary@nycha.nyc.gov, by: Thursday, October 20, 2016, 1:00 A.M.



o12-26

INDEPENDENT BUDGET OFFICE

MEETING

The New York City Independent Budget Office Advisory Board will hold a meeting on Wednesday, October 19, 2016, beginning at 8:30 A.M., at the IBO Office, 110 William Street, 14th Floor. There will be an opportunity for the public to address the advisory board during the public portion of the meeting. To request an alternative format or other accommodations, please contact Doug Turetsky, (212) 442-0629, dougt@ibo.nyc.ny.us, at least 72 hours prior to the meeting to ensure availability.

Accessibility questions: Doug Turetsky, (212) 442-0629, dougt@ibo.nyc.ny.us, by: Friday, October 14, 2016, 5:00 P.M.



o12-18

LANDMARKS PRESERVATION COMMISSION

PUBLIC HEARINGS

NOTICE IS HEREBY GIVEN that pursuant to the provisions of Title 25, Chapter 3 of the Administrative Code of the City of New York (Sections 25-303, 25-307, 25-308, 25-309, 25-313, 25-318, 25-320) on Tuesday, October 25, 2016, a public hearing will be held at 1 Centre Street, 9th Floor, Borough of Manhattan with respect to the following properties and then followed by a public meeting. The final order and estimated times for each application will be posted on the Landmarks Preservation Commission website the Friday before the hearing. Any person requiring reasonable accommodation in order to participate in the hearing or attend the meeting should contact the Landmarks Commission no later than Five (5) business days before the hearing or meeting.

237-02 Hollywood Avenue - Douglaston Historic District
 185159 - Block 8047 - Lot 1 - Zoning: R1-2
CERTIFICATE OF APPROPRIATENESS

A Mediterranean Revival style house built in 1927. Application is to replace windows.

316 Grosvenor Street - Douglaston Historic District
 181695 - Block 8036 - Lot 10 Zoning: R1-2

CERTIFICATE OF APPROPRIATENESS

An Arts and Crafts style house with Colonial Revival details designed by Edward A. Maclean and built in 1910. Application is to construct an addition and retaining walls and perform excavation.

39-88 44th Street - Sunnyside Gardens Historic District

186607 - Block 182 - Lot 25 - **Zoning:** R4

CERTIFICATE OF APPROPRIATENESS

A rowhouse designed by Clarence Stein, Henry Wright, and Frederick Ackerman and built in 1927. Application is to install a fence.

37-46 & 37-50 82nd Street - Jackson Heights Historic District

183951 - Block 1292 - Lot 31 - **Zoning:** C4-3

CERTIFICATE OF APPROPRIATENESS

Two commercial buildings, with 37-46 designed by Murray Klein and built in 1929 and 37-50 designed by M.A. Cantor and built in 1929, altered in 1986 with modern facades. Application is to alter the front facades.

1901 Emmons Avenue - Individual Landmark

183812 - Block 20 - Lot 29 - **Zoning:** R5

CERTIFICATE OF APPROPRIATENESS

A Spanish Colonial Revival style restaurant building designed by Bloch & Hesse and built in 1934. Application is to legalize façade, roof and site work performed without Landmarks Preservation Commission permit(s) and install a marquee.

20 Jay Street - DUMBO Historic District

193006 - Block 19 - Lot 1 - **Zoning:** M1-4/R8A

CERTIFICATE OF APPROPRIATENESS

An Industrial Neo-Classical style warehouse building designed by William Higginson and built in 1909. Application is to modify entry infill and loading platforms.

55 Washington Street - DUMBO Historic District

193005 - Block 38 - Lot 1 - **Zoning:** M1-2/R8A

CERTIFICATE OF APPROPRIATENESS

An Industrial Neo-Classical style factory building designed by William Higginson and built in 1904. Application is to modify entry infill and stair and ramp platforms.

25 Jay Street - DUMBO Historic District

191519 - Block 20 - Lot 6 - **Zoning:** M1-4/R8A

CERTIFICATE OF APPROPRIATENESS

A Renaissance Revival style factory building designed by Flemer & Koehler and built in 1892. Application is to modify entry infill installed without Landmarks Preservation Commission permit(s).

45 Main Street - DUMBO Historic District

193007 - Block 37 - Lot 1 - **Zoning:** M1-2/R8A

CERTIFICATE OF APPROPRIATENESS

An Industrial Neo-Classical style factory building designed by William Higginson and built in 1919. Application is to modify infill and install canopies.

203 DeKalb Avenue - Fort Greene Historic District

180489 - Block 2090 - Lot 67 - **Zoning:** R6B

CERTIFICATE OF APPROPRIATENESS

An Italianate style rowhouse built c. 1864. Application is to construct rooftop and rear yard additions.

109 Halsey Street - Bedford Historic District

186854 - Block 1838 - Lot 82 - **Zoning:** R6B

CERTIFICATE OF APPROPRIATENESS

A Neo-Grec style rowhouse designed by Isaac D. Reynolds and built c. 1880-82. Application is to legalize the construction of a rooftop addition, expansion of the rear parapet, and modifications to the rear façade without Landmarks Preservation Commission permit(s).

158 Halsey Street - Bedford Historic District

190630 - Block 1844 - Lot 40 - **Zoning:** R6B

CERTIFICATE OF APPROPRIATENESS

A Neo-Grec style house built c. 1882. Application is to construct a rear yard addition and alter the roof.

436 Macon Street - Bedford-Stuyvesant/Expanded Stuyvesant Heights Historic District

190876 - Block 1670 - Lot 26 - **Zoning:** R6B

CERTIFICATE OF APPROPRIATENESS

A Neo-Grec/Queen Anne style rowhouse designed by Amzi Hill and built c. 1884. Application is to legalize the installation of windows without Landmarks Preservation Commission permit(s).

136 MacDonough Street - Stuyvesant Heights Historic District

190384 - Block 1855 - Lot 38 **Zoning:** R6B

CERTIFICATE OF APPROPRIATENESS

A rowhouse built in 1888-89. Application is to enlarge windows at the rear façade.

288 Carroll Street - Carroll Gardens Historic District

184312 - Block 450 - Lot 28 - **Zoning:** R6B

CERTIFICATE OF APPROPRIATENESS

A rowhouse built in 1872-73. Application is to amend Certificate of Appropriateness 17-0036 for the construction of a rooftop addition.

118 Amity Street - Cobble Hill Historic District

183352 - Block 296 - Lot 10 - **Zoning:** R6

CERTIFICATE OF APPROPRIATENESS

A French Renaissance style nurses' residence building designed by William C. Hough and built in 1902. Application is to legalize the installation of a curb cut and work at side yard without Landmarks Preservation Commission permit(s), and to modify a gate.

130 8th Avenue - Park Slope Historic District

182922 - Block 1071 - Lot 14 - **Zoning:** R7B

CERTIFICATE OF APPROPRIATENESS

An apartment house designed by Rollin A. Caughey and built in 1950. Application is to modify the entrance and install a barrier-free access ramp.

566 10th Street - Park Slope Historic District Extension

191062 - Block 1094 - Lot 19 - **Zoning:** R6B

CERTIFICATE OF APPROPRIATENESS

A Neo-Grec style rowhouse designed by L. Bouard and built in 1887. Application is to construct rooftop and rear yard addition and replace windows.

8 Perry Street - Greenwich Village Historic District

186439 - Block 612 - Lot 53 - **Zoning:**

CERTIFICATE OF APPROPRIATENESS

A rowhouse built in 1849. Application is to construct a stoop, rooftop and rear yard additions.

23 Commerce Street - Greenwich Village Historic District

183292 - Block 587 - Lot 46 - **Zoning:** R6, C2-6

CERTIFICATE OF APPROPRIATENESS

An apartment house designed by Somerfield & Steckler and built in 1908-09. Application is to legalize the installation of storefront infill, awnings and a bracket sign and modifications to steps, without Landmarks Preservation Commission permit(s).

139 Charles Street - Greenwich Village Historic District Extension

186982 - Block 632 - Lot 34 - **Zoning:** C1-6A

CERTIFICATE OF APPROPRIATENESS

A garage designed by Sidney Daub and built in 1955. Application is to install storefront infill, signage, and HVAC equipment, and create a masonry opening.

327 West 4th Street - Greenwich Village Historic District

185249 - Block 615 - Lot 558 - **Zoning:** R6 C1-6

CERTIFICATE OF APPROPRIATENESS

A late Federal style row house built in 1827-28. Application is to construct a rooftop addition, excavate the rear yard, alter the rear façade, replace the front entrance, and paint façade elements.

46 Carmine Street - Greenwich Village Historic District Extension II

190092 - Block 527 - Lot 7502 - **Zoning:** R6

CERTIFICATE OF APPROPRIATENESS

A Federal style rowhouse built in 1827-28. Application is to alter the roof.

109 Spring Street - SoHo-Cast Iron Historic District

192402 - Block 499 - Lot 37 - **Zoning:** 12C

CERTIFICATE OF APPROPRIATENESS

A store and loft building designed by J.B. Snook and built in 1878. Application is to establish a Master Plan governing the future installation of painted wall signs.

486 Broadway, aka 437-441 Broome Street - SoHo-Cast Iron Historic District

190894 - Block 473 - Lot 14 **Zoning:** M1-5B

CERTIFICATE OF APPROPRIATENESS

A Romanesque style store building with Moorish details designed by Lamb & Rich and built in 1882-83. Application is to replace the fire escape.

200 9th Avenue - Chelsea Historic District

167947 - Block 746 - Lot 2 - **Zoning:** R7B

CERTIFICATE OF APPROPRIATENESS

An Italianate style building built in 1857. Application is to install a barrier-free access ramp.

900 Broadway - Ladies' Mile Historic District

192920 - Block 848 - Lot 61 - **Zoning:** M1-5M

CERTIFICATE OF APPROPRIATENESS

A commercial building designed by McKim, Mead, and White and built in 1886; and altered by Maynick & Franke in 1905. Application is to replace windows.

30-34 Morningside Drive, aka 401 West 113th Street, 400 West 114th Street - Individual and Interior Landmark

192369 - Block 1866 - Lot 1 - **Zoning:** 5C

CERTIFICATE OF APPROPRIATENESS

A French Renaissance Revival pavilion style hospital complex designed by Ernest Flagg and built in 1904-06 and 1928-29. Application is to construct additions and bulkheads, create and modify masonry

openings, create and modify window openings, install railings and barrier-free access ramps, and replace doors.

o12-25

OFFICE OF MANAGEMENT AND BUDGET

■ PUBLIC HEARINGS

City of New York Community Development Block Grant – Disaster Recovery (CDBG-DR)

Proposed Amendment 12 to Action Plan

NOTE: This notice provides an update to the notice originally published on September 23, 2016. The public hearing originally scheduled for October 17th, 2016, at Coney Island Hospital, has been rescheduled to October 20th, 2016. See below for more information.

Overview

The City of New York (“City” or “NYC”) is the recipient of \$4.214 billion of Community Development Block Grant – Disaster Recovery (CDBG-DR) funding from the U.S. Department of Housing and Urban Development (HUD) to assist in disaster recovery and rebuilding efforts resulting from Hurricane Sandy. The City’s approved CDBG-DR Action Plan details how the City plans to spend the grant on eligible Hurricane Sandy disaster recovery and rebuilding activities.

Any change greater than \$1 million in funding committed to a certain program, the addition or deletion of any program, or change in eligibility criteria or designated beneficiaries of a program constitutes a substantial amendment and such amendment will be available for review by the public and approval by HUD.

The City is publishing proposed Amendment 12 for public comment. Amendment 12 proposes the following changes:

General

- Reallocates funding across program areas to fund the completion of the Build it Back and Business Loan and Grant Programs.
- Note: Funding transferred to Housing from other recovery categories will be fully replaced with other City funds. All current planned projects will move forward without delays or gaps in funding or have already been completed. Sources of funding will consist of City Capital dollars committed as part of the September 2016 Capital Commitment Plan (\$350 million) and certain disaster response expenses, incurred by the City in prior fiscal years, that are no longer being reimbursed with CDBG-DR funding (\$150 million).
- Updates need assessments and funding justifications to reflect the reallocation of funds.
- Updates program descriptions where needed, to provide clarifying detail or current project status and information.

Housing

- Reallocates \$500 million to the Single Family Build it Back program to serve all eligible applicants.
- Updates Single Family Build it Back program description, explaining program pathways, additional benefits and needs assessment.
- Reduces Temporary Disaster Assistance Program (TDAP) allocation by \$10 million to reflect eligible population needs.
- Creates a new program benefit for TDAP to allow arrears payments to be made to landlords on behalf of beneficiaries that experience a gap in subsidy while transitioning from the program to Section 8 rental assistance.
- Reallocates \$9 million to NYCHA’s Program Allocation from the City’s Planning and Administration funding.
- Creates a new workforce development program targeting NYCHA residents.

Business

- Reallocates \$10 million to the Hurricane Sandy Business Loan and Grant Program to serve all eligible applicants.
- Reallocates \$12 million from the Restoration of Saw Mill Creek Marsh and \$15 million from the Rockaways Commercial Corridor Resiliency programs to fund needs in other program areas. Both programs will move forward with other sources of funding, including Capital funds the City is providing as part of the September 2016 Capital Commitment Plan.
- Updates the program description of the Coney Island Resiliency Improvements program, which was formerly

referred to as the Coney Island Green Infrastructure Improvements program.

Infrastructure and Other City Services (IOCS)

- Updates the overall IOCS allocation from \$755 million to \$419 million in order to fund needs in other program areas. CDBG-DR funding has been reduced across all IOCS program areas, however, projects previously identified either have already occurred and will now be funded with City funds instead of CDBG-DR, including Capital funds the City is providing as part of the September 2016 Commitment Plan. (Note: A version of this notice appearing in some newspapers on September 23, 2016 incorrectly indicates that the remaining IOCS allocation is \$434 million.)
- Reorganizes chapter to clarify where CDBG-DR funds have been committed and removes detail for programs that are no longer anticipated to receive CDBG-DR funding.

Coastal Resiliency

- Reallocates \$152 million from the Coastal Protection program to fund needs in other program areas. Components of the Raise Shorelines project and the Red Hook Integrated Flood Protection System will move forward with Capital funds the City is providing as part of the September 2016 Capital Commitment Plan. A portion of the Raise Shorelines Program will continue to be funded with CDBG-DR.

Planning and Administration

- Describes efforts to apply lessons learned and to develop tools for preparedness for future disasters.

The comment period on the proposed CDBG-DR Action Plan

Amendment 12 is now open. Comments must be received no later than October 24, 2016, at 11:59 P.M. (EST). The proposed CDBG-DR Action Amendment 12 and the public commenting forms are available at <http://www.nyc.gov/cdbg>. Individuals will be able to read the amendment and the currently approved Action Plan and comment on the amendment in English, Spanish, Russian and Chinese (simplified). The online materials will also be accessible for the visually impaired. Written comments may also be directed by mail to Calvin Johnson, Assistant Director, CDBG-DR, New York City Office of Management and Budget, 255 Greenwich Street, 8th Floor, New York, NY 10007. Public comments may be given in person at any of the three hearings listed below.

The schedule of public hearings for proposed Amendment 12 is listed below. Hearings are subject to change. Please call 311 or 212-NEW-YORK (212-639-9675) from outside New York City or check <http://www.nyc.gov/cdbg> for the most updated information.

Wednesday, October 5, 2016, at 7:00 P.M.

Beach Channel Educational Campus Auditorium
100-00 Beach Channel Drive, Rockaway Park, Queens

Thursday, October 13, 2016, at 7:00 P.M.

SIUH North Campus, Regina McGinn Education and Conference Center
475 Seaview Avenue, Staten Island

Thursday, October 20, 2016, at 7:00 P.M.

Coney Island Hospital Auditorium
2601 Ocean Parkway, Brooklyn
(Note: In a prior version of this notice, the date for this hearing appeared as Monday, October 17th, 2016. This hearing is rescheduled to October 20th, 2016.)

Paper copies of the Action Plan Amendment 12, including in large print format (18pt. font size), are available at the following address in both English and the languages listed above:

New York City Office of Management and Budget
255 Greenwich Street, 8th Floor Reception Area
New York, NY 10007

At the end of the comment period, all comments shall be reviewed and a City response will be incorporated into the City’s Responses to Public Comments document. A summary of the comments and the City’s responses will be submitted to HUD for approval in the final CDBG-DR Action Plan Amendment 12. The revised Action Plan Amendment 12 including the public comments and responses will be posted on the City’s CDBG-DR website at <http://www.nyc.gov/cdbg>.

o7-13

TRANSPORTATION

■ PUBLIC HEARINGS

NOTICE IS HEREBY GIVEN, pursuant to law, that the following proposed revocable consents, have been scheduled for a public hearing

by the New York City Department of Transportation. The hearing will be held at 55 Water Street, 9th Floor, Room 945, commencing at 2:00 P.M., on Wednesday, November 2, 2016. Interested parties can obtain copies of proposed agreements or request sign-language interpreters (with at least seven days prior notice) at 55 Water Street, 9th Floor South West, New York, NY 10041, or by calling (212) 839-6550.

#1 IN THE MATTER OF a proposed revocable consent authorizing Beth Israel Medical Center to continue to maintain and use a bridge over and across East 17th Street, east of Nathan D. Perlman Place, in the Borough of Manhattan. The proposed revocable consent is for a term of ten years from July 1, 2016 to June 30, 2026, and provides among other terms and conditions for compensation payable to the City according to the following schedule: **R.P. #1092**

- For the period July 1, 2016 to June 30, 2017 - \$17,387
- For the period July 1, 2017 to June 30, 2018 - \$17,776
- For the period July 1, 2018 to June 30, 2019 - \$18,165
- For the period July 1, 2019 to June 30, 2020 - \$18,554
- For the period July 1, 2020 to June 30, 2021 - \$18,943
- For the period July 1, 2021 to June 30, 2022 - \$19,332
- For the period July 1, 2022 to June 30, 2023 - \$19,721
- For the period July 1, 2023 to June 30, 2024 - \$20,110
- For the period July 1, 2024 to June 30, 2025 - \$20,499
- For the period July 1, 2025 to June 30, 2026 - \$20,888

the maintenance of a security deposit in the sum of \$20,900 and the insurance shall be in the amount of Two Million Dollars (\$2,000,000) per occurrence, and Two Million Dollars (\$2,000,000) aggregate.

#2 IN THE MATTER OF a proposed revocable consent authorizing Beth Israel Medical Center to continue to maintain and use a tunnel under and across East 16th Street, east of Nathan D. Perlman Place, in the Borough of Manhattan. The proposed revocable consent is for a term of ten years from July 1, 2016 to June 30, 2026 and provides among other terms and conditions for compensation payable to the City according to the following schedule: **R.P. #12**

- For the period July 1, 2016 to June 30, 2017 - \$17,757
- For the period July 1, 2017 to June 30, 2018 - \$18,155
- For the period July 1, 2018 to June 30, 2019 - \$18,553
- For the period July 1, 2019 to June 30, 2020 - \$18,951
- For the period July 1, 2020 to June 30, 2021 - \$19,349
- For the period July 1, 2021 to June 30, 2022 - \$19,747
- For the period July 1, 2022 to June 30, 2023 - \$20,145
- For the period July 1, 2023 to June 30, 2024 - \$20,543
- For the period July 1, 2024 to June 30, 2025 - \$20,941
- For the period July 1, 2025 to June 30, 2026 - \$21,339

the maintenance of a security deposit in the sum of \$21,400 and the insurance shall be in the amount of Two Million Dollars (\$2,000,000) per occurrence, and Two Million Dollars (\$2,000,000) aggregate.

#3 IN THE MATTER OF a proposed revocable consent authorizing Consolidated Edison Company of New York, Inc. to continue to maintain and use a conduit under and across River Street, south of Metropolitan Avenue, in the Borough of Brooklyn. The proposed revocable consent is for a term of ten years from July 1, 2016 to June 30, 2026, and provides among other terms and conditions for compensation payable to the City according to the following schedule: **R.P.# 877**

- For the period July 1, 2016 to June 30, 2017 - \$6,930
- For the period July 1, 2017 to June 30, 2018 - \$7,085
- For the period July 1, 2018 to June 30, 2019 - \$7,240
- For the period July 1, 2019 to June 30, 2020 - \$7,395
- For the period July 1, 2020 to June 30, 2021 - \$7,550
- For the period July 1, 2021 to June 30, 2022 - \$7,705
- For the period July 1, 2022 to June 30, 2023 - \$7,860
- For the period July 1, 2023 to June 30, 2024 - \$8,015
- For the period July 1, 2024 to June 30, 2025 - \$8,170
- For the period July 1, 2025 to June 30, 2026 - \$8,325

the maintenance of a security deposit in the sum of \$5,500 and the insurance shall be in the amount of Two Million Dollars (\$2,000,000) per occurrence, and Five Million Dollars (\$5,000,000) aggregate.

#4 IN THE MATTER OF a proposed revocable consent authorizing Consolidated Edison Company of New York, Inc. to continue to maintain and use two pipes under and across East 133rd Street, west of Locust Avenue, in the Borough of the Bronx. The proposed revocable consent is for a term of ten years from July 1, 2016 to June 30, 2026 and provides among other terms and conditions for compensation payable to the City according to the following schedule: **R.P. #892**

- For the period July 1, 2016 to June 30, 2017 - \$5,041
- For the period July 1, 2017 to June 30, 2018 - \$5,154
- For the period July 1, 2018 to June 30, 2019 - \$5,267
- For the period July 1, 2019 to June 30, 2020 - \$5,380
- For the period July 1, 2020 to June 30, 2021 - \$5,493
- For the period July 1, 2021 to June 30, 2022 - \$5,606
- For the period July 1, 2022 to June 30, 2023 - \$5,719
- For the period July 1, 2023 to June 30, 2024 - \$5,832

- For the period July 1, 2024 to June 30, 2025 - \$5,945
- For the period July 1, 2025 to June 30, 2026 - \$6,058

the maintenance of a security deposit in the sum of \$4,000 and the insurance shall be the amount of Two Million Dollars (\$2,000,000) per occurrence, and Five Million Dollars (\$5,000,000) aggregate.

#5 IN THE MATTER OF a proposed revocable consent authorizing Consolidated Edison Company of New York, Inc. to continue to maintain and use a water line under and across John Street, west of Gold Street, in the Borough of Brooklyn. The proposed revocable consent is for a term of ten years from July 1, 2016 to June 30, 2026, and provides among other terms and conditions for compensation payable to the City according to the following schedule: **R.P. #1093**

- For the period July 1, 2016 to June 30, 2017 - \$2,664
- For the period July 1, 2017 to June 30, 2018 - \$2,724
- For the period July 1, 2018 to June 30, 2019 - \$2,784
- For the period July 1, 2019 to June 30, 2020 - \$2,844
- For the period July 1, 2020 to June 30, 2021 - \$2,904
- For the period July 1, 2021 to June 30, 2022 - \$2,964
- For the period July 1, 2022 to June 30, 2023 - \$3,024
- For the period July 1, 2023 to June 30, 2024 - \$3,084
- For the period July 1, 2024 to June 30, 2025 - \$3,144
- For the period July 1, 2025 to June 30, 2026 - \$3,204

the maintenance of a security deposit in the sum of \$2,100 and the insurance shall be the amount of Two Million Dollars (2,000,000) per occurrence, and Five Million Dollars (\$5,000,000) aggregate.

#6 IN THE MATTER OF a proposed revocable consent authorizing Consolidated Edison Company of New York, Inc. to continue to maintain and use water lines under and along East 15th and East 16th Streets, between Avenue C and Franklin D. Roosevelt Drive and under and along Twelfth Avenue, between West 49th and West 54th Streets, in the Borough of Manhattan. The proposed revocable consent is for a term of ten years from July 1, 2016 to June 30, 2026, and provides among other terms and conditions for compensation payable to the City according to the following schedule: **R.P. #1104**

- For the period July 1, 2016 to June 30, 2017 - \$155,037
- For the period July 1, 2017 to June 30, 2018 - \$158,510
- For the period July 1, 2018 to June 30, 2019 - \$161,983
- For the period July 1, 2019 to June 30, 2020 - \$165,456
- For the period July 1, 2020 to June 30, 2021 - \$168,929
- For the period July 1, 2021 to June 30, 2022 - \$172,402
- For the period July 1, 2022 to June 30, 2023 - \$175,875
- For the period July 1, 2023 to June 30, 2024 - \$179,348
- For the period July 1, 2024 to June 30, 2025 - \$182,821
- For the period July 1, 2025 to June 30, 2026 - \$186,294

the maintenance of a security deposit in the sum of \$120,871 and the insurance shall be in the amount of Two Million Dollars (2,000,000) per occurrence, and Five Million Dollars (5,000,000) aggregate.

#7 IN THE MATTER OF a proposed revocable consent authorizing St. Luke's-Roosevelt Hospital Center to continue to maintain and use a bridge over and across West 114th Street, east of Amsterdam Avenue, in the Borough of Manhattan. The proposed revocable consent is for a term of ten years from July 1, 2016 to June 30, 2026 and provides among other terms and conditions for compensation payable to the City according to the following schedule: **R.P. #758**

- For the period July 1, 2016 to June 30, 2017 - \$20,554
- For the period July 1, 2017 to June 30, 2018 - \$21,014
- For the period July 1, 2018 to June 30, 2019 - \$21,474
- For the period July 1, 2019 to June 30, 2020 - \$21,934
- For the period July 1, 2020 to June 30, 2021 - \$22,394
- For the period July 1, 2021 to June 30, 2022 - \$22,854
- For the period July 1, 2022 to June 30, 2023 - \$23,314
- For the period July 1, 2023 to June 30, 2024 - \$23,774
- For the period July 1, 2024 to June 30, 2025 - \$24,234
- For the period July 1, 2025 to June 30, 2026 - \$24,694

the maintenance of a security deposit in the sum of \$24,700 and the insurance shall be the amount of Two Million Dollars (2,000,000) per occurrence, and Two Million Dollars (2,000,000) aggregate.

#8 IN THE MATTER OF a proposed revocable consent authorizing St. Luke's Roosevelt Hospital Center to continue to maintain and use a tunnel under and across West 114th Street, east of Amsterdam Avenue, in the Borough of Manhattan. The proposed revocable consent is for a term of ten years from July 1, 2016 to June 30, 2026 and provides among other terms and conditions for compensation payable to the City according to the following schedule: **R.P. #806**

- For the period July 1, 2016 to June 30, 2017 - \$13,535
- For the period July 1, 2017 to June 30, 2018 - \$13,838
- For the period July 1, 2018 to June 30, 2019 - \$14,141
- For the period July 1, 2019 to June 30, 2020 - \$14,444
- For the period July 1, 2020 to June 30, 2021 - \$14,747
- For the period July 1, 2021 to June 30, 2022 - \$15,050
- For the period July 1, 2022 to June 30, 2023 - \$15,353
- For the period July 1, 2023 to June 30, 2024 - \$15,656

For the period July 1, 2024 to June 30, 2025- \$15,959
For the period July 1, 2025 to June 30, 2026 -\$16,262

the maintenance of a security deposit in the sum of \$16,300 and the insurance shall be the amount of Two Million Dollars (2,000,000) per occurrence, and Two Million Dollars (2,000,000) aggregate.

#9 IN THE MATTER OF a proposed revocable consent authorizing Brickman 95 Morton LLC to construct, maintain and use stairs and a lift on the south sidewalk of Barrow Street, east of Washington Street, in the Borough of Manhattan. The proposed revocable consent is for a term of ten years from Date of Approval by the Mayor and provides among other terms and conditions for compensation payable to the City according to the following schedule: **R.P. #2351**

From the approval Date to June 30, 2017 - \$2,686/annum

- For the period July 1, 2017 to June 30, 2018 - \$2,746
- For the period July 1, 2018 to June 30, 2019 - \$2,806
- For the period July 1, 2019 to June 30, 2020 - \$2,866
- For the period July 1, 2020 to June 30, 2021 - \$2,926
- For the period July 1, 2021 to June 30, 2022 - \$2,986
- For the period July 1, 2022 to June 30, 2023 - \$3,046
- For the period July 1, 2023 to June 30, 2024 - \$3,106
- For the period July 1, 2024 to June 30, 2025 - \$3,166
- For the period July 1, 2025 to June 30, 2026 - \$3,226
- For the period July 1, 2026 to June 30, 2027 - \$3,286

the maintenance of a security deposit in the sum of \$10,000 and the insurance shall be the amount of Two Million Dollars (2,000,000) per occurrence, and Two Million Dollars (2,000,000) aggregate.

o13-n2

COMMUTER VAN SERVICE AUTHORITY APPLICATION

NOTICE IS HEREBY GIVEN that the Department of Transportation is conducting a public hearing on a Van Authority in the Borough of Queens and Manhattan. The van company, L & W Express Van Services Corp., is requesting an expansion of vehicles. The company address is 136-31 41st Avenue, Apartment 4C, Flushing, NY 11355. The applicant is currently authorized to use 23 vans and is proposing to use an additional 15 vans daily to provide this service 16 hours a day.

There will be a public hearing held on Monday, October 24, 2016 at the Queens Borough Hall, Room 213, Part 1, 120-55 Queens Boulevard, Kew Gardens, NY 11424 from 2:00 P.M. - 4:00 P.M. and on Thursday, October 27, 2016 at the Manhattan Borough President's Office, One Centre Street, 19th Floor South, New York, NY 10007 from 2:00 P.M. - 4:00 P.M. so that you may have an opportunity to voice your position on this application. In addition, written comments in support or in opposition to this application may be sent to Ms. Dorothy Szorc, at the New York City Department of Transportation, Transportation Planning & Management, 55 Water Street, 6th Floor, New York, NY 10041 no later than October 27, 2016. Any written comments received after this date may not be considered. Those opposing the application must clearly specify why the proposed service will not meet present and/or future public convenience and necessity.

o11-17

COMMUTER VAN SERVICE AUTHORITY APPLICATION

NOTICE IS HEREBY GIVEN that the Department of Transportation is conducting a public hearing on a Van Authority in the Borough of Queens and Manhattan. The van company, Eight Star, Inc., is requesting an expansion of vehicles. The company address is 136-31 41st Avenue #PH, Flushing, NY 11355. The applicant is currently authorized to use 10 vans and is proposing to use an additional 15 vans daily to provide this service 16 hours a day.

There will be a public hearing held on Monday, October 24, 2016, at the Queens Borough Hall, Room 213, Part 1, 120-55 Queens Boulevard, Kew Gardens, NY 11424 from 2:00 P.M.- 4:00 P.M., and on Thursday, October 27, 2016 at the Manhattan Borough President's Office, One Centre Street, 19th Floor South, New York, NY 10007 from 2:00 P.M. - 4:00 P.M., so that you may have an opportunity to voice your position on this application. In addition, written comments in support or in opposition to this application may be sent to Ms. Dorothy Szorc, at the New York City Department of Transportation, Transportation Planning & Management, 55 Water Street, 6th Floor, New York, NY 10041 no later than October 27, 2016. Any written comments received after this date may not be considered. Those opposing the application must clearly specify why the proposed service will not meet present and/or future public convenience and necessity.

o7-14

Commuter Van Service Authority Six-Year Renewal

NOTICE IS HEREBY GIVEN that the Department of Transportation is conducting a Public Hearing on the Six-Year Renewal of a Van

Authority, in the Borough of Brooklyn and Staten Island. The van company requesting renewal is:

- **TD Van Service, Inc. 133-56 41st Avenue, Flushing, NY 11355**

There will be a Public Hearing held on Monday, October 31, 2016 from 2:00 P.M. to 4:00 P.M., at the Brooklyn Borough Commissioner's Office, 16 Court Street, 16th Floor, Small Conference Room 1620, New York, NY 11241, so that you may have an opportunity to voice your position on this application. In addition, written comments in support or in opposition may be sent to Ms. Dorothy Szorc, at the New York City Department of Transportation, Transportation Planning and Management, 55 Water Street, 6th Floor, New York, NY 10041, no later than October 31, 2016. Any written comments received after this date may not be considered. Those opposing the renewal must clearly specify why the existing services will not meet present and/or future public convenience and necessity.

o7-14

COURT NOTICES

SUPREME COURT

KINGS COUNTY

NOTICE

**KINGS COUNTY
IA PART 89
NOTICE OF PETITION
INDEX NUMBER 517650/2016
CONDEMNATION PROCEEDING**

IN THE MATTER OF the Application of the City of New York, relative to acquiring title in fee simple absolute to certain real property known as:

BLOCK 7074, PARTS OF LOTS 4, 23 AND 105 in the Borough of Brooklyn, City and State of New York,

Required to establish New Streets and Parkland in connection with the Coney Island Plan – Stage 1.

PLEASE TAKE NOTICE that the Corporation Counsel of the City of New York intends to make application to the Supreme Court of the State of New York, Kings County, IA Part 89, for certain relief.

The application will be made at the following time and place: At 360 Adams Street, in the Borough of Kings, City and State of New York, on October 27, 2016 at 2:00 P.M., or as soon thereafter as counsel can be heard.

The application is for an order:

1. authorizing the City to file the acquisition map, in the Office of the City Register;
2. directing that, upon the filing of said map, title to the property sought to be acquired shall vest in the City;
3. providing that just compensation therefor be ascertained and determined by the Supreme Court without a jury; and
4. providing that notices of claim must be served and filed within one calendar year from the date of service of the Notice of Acquisition for this proceeding.

The City of New York, in this proceeding, intends to acquire title in fee simple absolute to certain real property— parts of tax lots 4, 23 and 105, in Block 7074 - located in Coney Island, Brooklyn, New York, for the development of new streets and parkland in furtherance of the Coney Island Plan.

The real property which is to be acquired in fee simple absolute in this proceeding is all those certain tracts of land, together with the buildings and improvements erected thereon and the appurtenances thereunto belonging situated in the Borough of Brooklyn, City and State of New York, bounded and described as follows:

BEGINNING at a point on the southerly side of Surf Avenue, distant 181.61 feet westerly along a curve to the left having a radius of 3940.00 feet and an interior angle of 2°38'28" from the corner formed by the intersection of the southerly side of Surf Avenue with the westerly side of West 15th Street;

RUNNING THENCE southerly along a line forming an angle of

90°17'15" from the tangent line of the last course along the easterly side of the proposed West 16th Street right of way a distance of 509.46 feet to a point of curvature;

THENCE southeasterly along said easterly side of the proposed West 16th Street right of way and being a curve to the left an arc distance of 43.68 feet having a radius of 50.00 feet and an interior angle of 50°03'04" to a point of compound curvature;

THENCE southeasterly along said easterly side of the proposed West 16th Street right of way and being a curve to the right an arc distance of 20.31 feet having a radius of 45.00 feet and an interior angle of 25°51'38" to an angle point on the north side of the proposed West Walk;

THENCE northeasterly along a line forming an angle of 104°00'17" from the tangent line to last course along said north side of the proposed West Walk a distance of 104.34 feet to a point;

THENCE southerly along a line forming an interior angle of 79°46'11" with the previous course, a distance of 311.60 feet to a point on the northerly side of the Riegelmann Boardwalk;

THENCE westerly along a line forming an interior angle of 91°18'24" with the previous course, a distance of 149.65 feet to a point;

THENCE northerly along a line forming an interior angle of 88°44'14" with the previous course, a distance of 860.13 feet to a point on the southerly side of Surf Avenue;

THENCE easterly along a line forming an interior angle of 90°38'18" with the previous course, a distance of 4.49 feet to a point of curvature;

THENCE easterly along the southerly side of Surf Avenue and along a curve bearing to the right an arc distance of 12.62 feet having a radius of 3940.00 feet and an interior angle of 0°11'01" to the point or place of BEGINNING.

Said parcel containing an area of 55,346.01 SF or 1.271 acres.

Surveys, maps or plans of the property to be acquired are on file in the office of the Corporation Counsel of the City of New York, 100 Church Street, New York, NY 10007.

PLEASE TAKE FURTHER NOTICE that, pursuant to EDPL § 402(B)(4), any party seeking to oppose the acquisition must interpose a verified answer, which must contain specific denial of each material allegation of the petition controverted by the opponent, or any statement of new matter deemed by the opponent to be a defense to the proceeding. Pursuant to CPLR 403, said answer must be served upon the office of the Corporation Counsel at least seven (7) days before the date that the petition is noticed to be heard.

Dated: New York, NY
October 6, 2016

ZAHARY W. CARTER
Corporation Counsel of the City of New York
Attorney for the Condemnor,
100 Church Street,
New York, NY 10007
(212) 356-2140

SEE MAPS IN BACK OF PAPER

◀ o13-26

RICHMOND COUNTY

■ NOTICE

**RICHMOND COUNTY
IA PART 89
NOTICE OF PETITION
INDEX NUMBER CY4501/2016
CONDEMNATION PROCEEDING**

IN THE MATTER OF the Application of the CITY OF NEW YORK, Relative to Acquiring Title in Fee Simple to Property, located in Staten Island, including All or Parts of:

SOUTH AVENUE from Netherland Avenue to Forest Avenue In the Borough of Staten Island, City and State of New York.

PLEASE TAKE NOTICE that the City of New York (the "City") intends to make application to the Supreme Court of the State of New York, Richmond County, IA Part 89, for certain relief.

The application will be made at the following time and place: At the Kings County Courthouse, located at 360 Adams Street, in the Borough of Brooklyn, City and State of New York, on October 27, 2016 at 2:00 P.M., or as soon thereafter as counsel can be heard.

The application is for an order:

- 1. authorizing the City to file the acquisition map, in the Richmond County Clerk's Office;
- 2. directing that, upon the filing of said map, title to the property

- sought to be acquired shall vest in the City;
- 3. providing that just compensation therefore be ascertained and determined by the Supreme Court without a jury; and
- 4. providing that notices of claim must be served and filed within one calendar year from the date of service of the Notice of Acquisition for this proceeding.
- 5. The City of New York, in this proceeding, intends to acquire title in fee simple absolute to certain real property where not heretofore acquired for the same purpose, for the reconstruction of roadways, sidewalks, and curbs, the installation of new storm and sanitary sewers, and the upgrading of existing water mains, in the Borough of Staten Island, City and State of New York.
- 6. The real property which is to be acquired in fee simple absolute in this proceeding is described as follows:

ALL that certain plot, piece or parcel of land, situate, lying and being in the Borough of Staten Island, County of Richmond, City and State of New York, as bounded and described as follows:

BEGINNING at the corner formed by the intersection of the northerly side of Forest Avenue and the westerly side of South Avenue;

RUNNING THENCE along the westerly side of South Avenue, North 01 degree 39 minutes 38 seconds East, a distance of 591.12 feet to a point;

THENCE South 88 degrees 01 minute 09 seconds East, a distance of 80.00 feet to a point;

THENCE through a bed of Netherland Avenue and along the easterly side of South Avenue, South 01 degree 39 minutes 38 seconds West, a distance of 608.86 feet to a corner formed by the intersection of the northerly side of Forest Avenue and the easterly side of South Avenue;

THENCE North 75 degrees 31 minutes 52 seconds West, a distance of 82.04 feet to a point or place of BEGINNING.

Said parcels containing 47,998.675 square feet or 1.102 acres.

- 7. The above described property shall be acquired subject to encroachments, if any, so long as said encroachments shall stand, as delineated on the Damage and Acquisition Map.
- 8. Surveys, maps or plans of the property to be acquired are on file in the office of the Corporation Counsel of the City of New York, 100 Church Street, New York, NY 10007.

Dated: New York, NY
October 6, 2016

ZAHARY W. CARTER
Corporation Counsel of the
City of New York
Attorney for the Condemnor,
100 Church Street,
New York, NY 10007
(212) 356-2670

SEE MAPS IN BACK OF PAPER

◀ o13-26

PROPERTY DISPOSITION

CITYWIDE ADMINISTRATIVE SERVICES

■ SALE

The City of New York in partnership with PropertyRoom.com posts vehicle and heavy machinery auctions online every week at: <https://www.propertyroom.com/s/nyc+fleet>

All auctions are open to the public and registration is free.

Vehicles can be viewed in person by appointment at: Kenben Industries Ltd., 1908 Shore Parkway, Brooklyn, NY 11214. Phone: (718) 802-0022

o11-m29

OFFICE OF CITYWIDE PROCUREMENT

■ NOTICE

The Department of Citywide Administrative Services, Office of Citywide Procurement is currently selling surplus assets on the internet. Visit

<http://www.publicsurplus.com/sms/nycdcas.ny/browse/home>.

To begin bidding, simply click on 'Register' on the home page.

There are no fees to register. Offerings may include but are not limited to: office supplies/equipment, furniture, building supplies, machine tools, HVAC/plumbing/electrical equipment, lab equipment, marine equipment, and more.

Public access to computer workstations and assistance with placing bids is available at the following locations:

- DCAS Central Storehouse, 66-26 Metropolitan Avenue, Middle Village, NY 11379
- DCAS, Office of Citywide Procurement, 1 Centre Street, 18th Floor, New York, NY 10007

j4-d30

POLICE

■ NOTICE

OWNERS ARE WANTED BY THE PROPERTY CLERK DIVISION OF THE NEW YORK CITY POLICE DEPARTMENT

The following listed property is in the custody of the Property Clerk Division without claimants: Motor vehicles, boats, bicycles, business machines, cameras, calculating machines, electrical and optical property, furniture, furs, handbags, hardware, jewelry, photographic equipment, radios, robes, sound systems, surgical and musical instruments, tools, wearing apparel, communications equipment, computers, and other miscellaneous articles.

Items are recovered, lost, abandoned property obtained from prisoners, emotionally disturbed, intoxicated and deceased persons; and property obtained from persons incapable of caring for themselves.

INQUIRIES

Inquiries relating to such property should be made in the Borough concerned, at the following office of the Property Clerk.

FOR MOTOR VEHICLES (All Boroughs):

- Springfield Gardens Auto Pound, 174-20 North Boundary Road, Queens, NY 11430, (718) 553-9555
- Erie Basin Auto Pound, 700 Columbia Street, Brooklyn, NY 11231, (718) 246-2030

FOR ALL OTHER PROPERTY

- Manhattan - 1 Police Plaza, New York, NY 10038, (646) 610-5906
- Brooklyn - 84th Precinct, 301 Gold Street, Brooklyn, NY 11201, (718) 875-6675
- Bronx Property Clerk - 215 East 161 Street, Bronx, NY 10451, (718) 590-2806
- Queens Property Clerk - 47-07 Pearson Place, Long Island City, NY 11101, (718) 433-2678
- Staten Island Property Clerk - 1 Edgewater Plaza, Staten Island, NY 10301, (718) 876-8484

j4-d30

PROCUREMENT

"Compete To Win" More Contracts!

Thanks to a new City initiative - "Compete To Win" - the NYC Department of Small Business Services offers a new set of FREE services to help create more opportunities for minority and women-owned businesses to compete, connect and grow their business with the City. With NYC Construction Loan, Technical Assistance, NYC Construction Mentorship, Bond Readiness, and NYC Teaming services, the City will be able to help even more small businesses than before.

- *Win More Contracts at nyc.gov/competetowin*

"The City of New York is committed to achieving excellence in the design and construction of its capital program, and

building on the tradition of innovation in architecture and engineering that has contributed to the City's prestige as a global destination. The contracting opportunities for construction/construction services and construction-related services that appear in the individual agency listings below reflect that commitment to excellence."

HHS ACCELERATOR

To respond to human services Requests for Proposals (RFPs), in accordance with Section 3-16 of the Procurement Policy Board Rules of the City of New York ("PPB Rules"), vendors must first complete and submit an electronic prequalification application using the City's Health and Human Services (HHS) Accelerator System. The HHS Accelerator System is a web-based system maintained by the City of New York for use by its human services Agencies to manage procurement. The process removes redundancy by capturing information about boards, filings, policies, and general service experience centrally. As a result, specific proposals for funding are more focused on program design, scope, and budget.

Important information about the new method

- Prequalification applications are required every three years.
- Documents related to annual corporate filings must be submitted on an annual basis to remain eligible to compete.
- Prequalification applications will be reviewed to validate compliance with corporate filings, organizational capacity, and relevant service experience.
- Approved organizations will be eligible to compete and would submit electronic proposals through the system.

The Client and Community Service Catalog, which lists all Prequalification service categories and the NYC Procurement Roadmap, which lists all RFPs to be managed by HHS Accelerator may be viewed at <http://www.nyc.gov/html/hhsaccelerator/html/roadmap/roadmap.shtml>. All current and prospective vendors should frequently review information listed on roadmap to take full advantage of upcoming opportunities for funding.

Participating NYC Agencies

HHS Accelerator, led by the Office of the Mayor, is governed by an Executive Steering Committee of Agency Heads who represent the following NYC Agencies:

- Administration for Children's Services (ACS)
- Department for the Aging (DFTA)
- Department of Consumer Affairs (DCA)
- Department of Corrections (DOC)
- Department of Health and Mental Hygiene (DOHMH)
- Department of Homeless Services (DHS)
- Department of Probation (DOP)
- Department of Small Business Services (SBS)
- Department of Youth and Community Development (DYCD)
- Housing and Preservation Department (HPD)
- Human Resources Administration (HRA)
- Office of the Criminal Justice Coordinator (CJC)

To sign up for training on the new system, and for additional information about HHS Accelerator, including background materials, user guides and video tutorials, please visit www.nyc.gov/hhsaccelerator

ADMINISTRATION FOR CHILDREN'S SERVICES

■ AWARD

Human Services/Client Services

EARLYLEARN SERVICES - Renewal - PIN#06811P0012088R001 - AMT: \$1,354,845.08 - TO: Lincoln Square Neighborhood Center Inc., 250 West 64th Street, New York, NY 10023.

- **VIOLENCE PREVENTION** - Line Item Appropriation or Discretionary Funds - Available only from a single source - PIN# 06816L0039001 - AMT: \$50,000.00 - TO: Life Camp, Inc., 111-12 Stuphin Boulevard, Jamaica, NY 11435.

◀ o13

ADMINISTRATIVE TRIALS AND HEARINGS

AGENCY CHIEF CONTRACTING OFFICER

■ INTENT TO AWARD

Services (other than human services)

AUTOMATED GENERATION, PRINTING AND MAILING OF NOTICES OF VIOLATIONS - Negotiated Acquisition/Pre-Qualified

List - PIN#82012M0001001N001 - Due 10-21-16 at 11:00 A.M.

This notice of intent to enter into negotiations is being published for informational purposes. The Office of Administrative Trials and Hearings (OATH) intends to enter into a negotiated acquisition extension contract with New York State Industries for the Disabled, Inc., for the provision of automated generation, printing and mailing of notices of violations. OATH is currently in the process of procuring a new service contract through preferred source or Competitive Sealed Bids (CSB) method but this procurement has not yet been completed.

The term of the contract will be from December 1, 2016 through November 30, 2017.

Any firm that believes it can provide this service in the future is invited to submit an expression of interest which must be received by October 21, 2016 by 5:00 P.M. Expression of interest should be sent to Brian Genzmann at BGenzmann2@oath.nyc.gov.

Use the following address unless otherwise specified in notice, to secure, examine or submit bid/proposal documents, vendor pre-qualification and other forms; specifications/blueprints; other information; and for opening and reading of bids at date and time specified above.

Administrative Trials and Hearings, 100 Church Street, 12th Floor, New York, NY 10007. Brian Genzmann (212) 933-3062; bgenzmann2@oath.nyc.gov

o7-14

BROOKLYN NAVY YARD DEVELOPMENT CORPORATION

TECHNOLOGY

■ SOLICITATION

Services (other than human services)

DESIGN, INSTALLATION AND CONFIGURATION OF NETWORK SERVICES - Competitive Sealed Proposals - Judgment required in evaluating proposals - PIN#0001222 - Due 10-28-16 at 12:00 P.M.

A mandatory Pre-Bid Conference Meeting will be held at BNYDC, Building 292, 3rd Floor Conference Room, on Friday, October 14, 2016, at 3:00 P.M. Failure to attend will result in proposer disqualification.

● **INSTALLATION AND CONFIGURATION OF VIDEO SECURITY AND ACCESS CONTROL SYSTEMS** - Competitive Sealed Proposals - Judgment required in evaluating proposals - PIN#0001223 - Due 10-28-16 at 12:00 P.M.

The Brooklyn Navy Yard Development Corporation (BNYDC) is seeking to retain a Value Added Reseller (VAR) to install and configure Video and Access Control Security systems for a newly renovated building and integrating the systems into the Brooklyn Navy Yard's existing security systems.

A mandatory Pre-Bid Conference Meeting will be held at BNYDC, Building 292, 3rd Floor Conference Room, on Friday, October 14, 2016, at 9:00 A.M. Failure to attend will result in proposer disqualification.

Use the following address unless otherwise specified in notice, to secure, examine or submit bid/proposal documents, vendor pre-qualification and other forms; specifications/blueprints; other information; and for opening and reading of bids at date and time specified above.

Brooklyn Navy Yard Development Corporation, 63 Flushing Avenue, Building 292, Brooklyn, NY 11205. Pasquale Cirullo (718) 907-5974; Fax: (718) 643-9296; pcirullo@brooklynnavyard.org

o12-14

BUILDINGS

CONTRACTS

■ SOLICITATION

Services (other than human services)

CRANE TECHNOLOGY SOLUTION - Request for Information - PIN#81017RF10001 - Due 11-18-16 at 3:00 P.M.

Use the following address unless otherwise specified in notice, to secure, examine or submit bid/proposal documents, vendor pre-qualification and other forms; specifications/blueprints; other information; and for opening and reading of bids at date and time specified above.

Buildings, 280 Broadway, 6th Floor, New York, NY 10007. Leesel Wong (212) 393-2242; Fax: (646) 500-6194; leewong@buildings.nyc.gov

o13

CITY UNIVERSITY

LAGUARDIA COMMUNITY COLLEGE

■ INTENT TO AWARD

Services (other than human services)

INTEGRATED TESTING PROGRAM W/ NCLEX-RN - Sole Source - Available only from a single source - PIN#09302016 - Due 10-21-16 at 2:00 P.M.

LaGuardia Community College, CUNY is looking into entering a sole source agreement with Kaplan, Inc., for the development of a test review program to prepare nursing students and international nurses for the NCLEX-RN examination.

If you believe that your company can provide these services, please send your profile via email pricequote@lagcc.cuny.edu, or fax (718) 609-2166, no later than the due date of this ad.

Any purchase that results from this advertisement shall be governed by the terms and conditions of this advertisement (including without limitation, any attached specifications and any other terms and conditions attached hereto or incorporated herein by reference), the University's standard Purchase Order Terms and Conditions and Appendix A, the Standard Clauses for New York State Contracts, which are incorporated herein by reference with the same effect as it is written.

Communication with respect to this procurement initiated by or on behalf of an interested vendor through others may constitute an "impermissible contact" under State law, and could result in disqualification of that vendor. No subcontracting allowed.

The Procurement Lobbying Act (PLA) applies to this Solicitation. The restricted period began with the publication of this ad.

Compliance Procurement Lobbying Act

Required Forms: Vendor shall complete, sign and submit the following forms if they are selected.

- a) "Offerer's Affirmation of Understanding of and Agreement pursuant to State Finance Law § 139-j (3) and § 139-j (6) (b)"
- b) "Offerer's Disclosure of Prior Non-Responsibility Determinations and Certification of Compliance with State Finance Law §139-j and §139-k"

Contact with CUNY:

Under the requirements of the PLA, all communications regarding advertised projects are to be channeled through the Designated Contact. Communication with respect to this procurement initiated by or on behalf of an interested vendor through others than the Designated Contact may constitute an "impermissible contact" under NYS law and could result in disqualification of that vendor.

Rules and regulations and more information on this law, please visit: <http://www.ogs.ny.gov/aboutogs/regulations/advisoryCouncil/Faq.htm> (Advisory Council FAQs) <http://www.jcope.ny.gov/law/lob/lobbying2.html> (New York State Lobbying Act)

Use the following address unless otherwise specified in notice, to secure, examine or submit bid/proposal documents, vendor pre-qualification and other forms; specifications/blueprints; other information; and for opening and reading of bids at date and time specified above.

City University, 31-10 Thomson Avenue, Room E405, Long Island City, NY 11101. Tawannika Smith (718) 482-5525; Fax: (718) 609-2166; pricequote@lagcc.cuny.edu

o6-13

CITYWIDE ADMINISTRATIVE SERVICES

OFFICE OF CITYWIDE PROCUREMENT

■ SOLICITATION

Goods

SPONGES, CELLULOSE - Competitive Sealed Bids - PIN#8571700021 - Due 11-17-16 at 10:30 A.M.

A copy of the bid can be downloaded from the City Record Online site at www.nyc.gov/cityrecord. Enrollment is free. Vendors may also request the bid by contacting Vendor Relations via email at dcasdmssbids@dcas.nyc.gov, by telephone at (212) 386-0044 or by fax at (212) 669-7585.

Use the following address unless otherwise specified in notice, to secure, examine or submit bid/proposal documents, vendor pre-qualification and other forms; specifications/blueprints; other

information; and for opening and reading of bids at date and time specified above.
 Citywide Administrative Services, 1 Centre Street, 18th Floor, New York, NY 10007. Michelle McCoy (212) 386-0469; mmccoy@dcas.nyc.gov

o13

AWARD

Goods

SALT, HIGHWAY DE-ICING - Competitive Sealed Bids - PIN# 8571600378 - AMT: \$1,059,800.00 - TO: Morton Salt Inc., 123 North Wacker Drive, Chicago, IL 60606-1743.

o13

DESIGN AND CONSTRUCTION

AGENCY CHIEF CONTRACTING OFFICER

SOLICITATION

Construction/Construction Services

BRONX CHILDREN'S MUSEUM-BOROUGH OF THE BRONX - Competitive Sealed Bids - PIN#85016B0161 - Due 11-15-16 at 2:00 P.M. PROJECT NO.P-1YANK15A/DDC PIN:8502015WM0015C

Bid document deposit-\$35.00 per set-company check or money order only-no cash accepted-late bids will not be accepted. Special experience requirements. Apprenticeship participation requirements apply to this contract. Bid documents are available at: <http://ddcbiddocuments.nyc.gov/inet/html/contrbid.asp>

*" New York State MWBE requirements apply to this contract. Accordingly, please review and fully complete Exhibits H through H(6) in Volume 2 of this Contract."

Use the following address unless otherwise specified in notice, to secure, examine or submit bid/proposal documents, vendor pre-qualification and other forms; specifications/blueprints; other information; and for opening and reading of bids at date and time specified above.

Design and Construction, 30-30 Thomson Avenue, First Floor, Long Island City, NY 11101. Brenda Barreiro (718) 391-1041; Fax: (718) 391-2615; barreibob@ddc.nyc.gov

o13

PROFESSIONAL CONTRACTS

AWARD

Construction/Construction Services

ENGINEERING DESIGN AND RELATED SERVICES FOR SELECT BUS SERVICE - Request for Proposals - PIN#8502016RQ00046P - AMT: \$15,000,000.00 - TO: Camp Dresser McKee and Smith, 14 Wall Street, Suite 1702, New York, NY 10005.

o13

ENVIRONMENTAL PROTECTION

WASTEWATER TREATMENT

SOLICITATION

Services (other than human services)

CORRECTION: MAINTENANCE OF PETROLEUM BULK STORAGE TANKS AT VARIOUS WASTEWATER TREATMENT PLANT. - Competitive Sealed Bids - PIN#82616B0045 - Due 11-3-16 at 11:30 A.M.

Contract Number: 1432-PBS(R), Document Fee: \$80, Gerson Tavarez, GTavarez@dep.nyc.gov. There will be a Pre-Bid Conference on 10/20/16, at 96-05 Horace Harding Expressway, 2nd Floor Conference Room #4, Flushing, NY 11373, at 10:00 A.M. Last day for questions 10/26/16, email agency contact.

The procurement is subject to participation goals for MBEs and/or WBEs as required by Local Law 1. This contract is subject to Apprenticeship Program Questionnaire. 9.5 percent M/WBE Subcontracting

Use the following address unless otherwise specified in notice, to secure, examine or submit bid/proposal documents, vendor pre-qualification and other forms; specifications/blueprints; other information; and for opening and reading of bids at date and time

specified above.
 Environmental Protection, 59-17 Junction Boulevard, 17th Floor Bid Room, Flushing, NY 11373. Fabian Heras (718) 595-3265; fheras@dep.nyc.gov



o13

FINANCE

AGENCY CHIEF CONTRACTING OFFICE

AWARD

Goods

LENOVO THINKPAD NOTEBOOKS - Intergovernmental Purchase - Other - PIN#83616O0009001 - AMT: \$184,380.00 - TO: Asi System Integration, Inc., 48 West 37th Street, 4th Floor, New York, NY 10018.

Available through NYS OGS Contract.

o13

HEALTH AND MENTAL HYGIENE

OFFICE OF EXTERNAL AFFAIRS

INTENT TO AWARD

Services (other than human services)

MEDIA BUYER FOR BUS STOP SHELTERS - Sole Source - Available only from a single source - PIN#17EO005301R0X00 - Due 10-24-16 at 11:00 A.M.

DOHMH intends to enter a Sole Source contract with JCDecaux Street Furniture New York, LLC. to reserve and lease space for DOHMH's public health advertising on New York City bus shelters. This procurement will provide bus shelter advertising space to DOHMH for the purpose of educating New York City residents on health risks and preventions. DOHMH has determined that JCDecaux Street Furniture New York, LLC is the sole source provider for the required advertising services, as they are the only vendor authorized (via a franchise agreement) by the New York City Department of Transportation to sell advertising space on bus stop shelters.

Any vendor that believes it can provide the proposed services are welcome to submit an expression of interest via email to swillia9@health.nyc.gov no later than 10/24/2016 by 11:00 A.M. All questions and concerns should also be submitted via email.

Use the following address unless otherwise specified in notice, to secure, examine or submit bid/proposal documents, vendor pre-qualification and other forms; specifications/blueprints; other information; and for opening and reading of bids at date and time specified above.

Health and Mental Hygiene, 42-09 28th Street, 17th Floor, Long Island City, NY 11101. Shamecka Williams (347) 396-6656; Fax: (347) 396-6758; swillia9@health.nyc.gov

o7-14

HOUSING AUTHORITY

SUPPLY MANAGEMENT

SOLICITATION

Goods

PLUMBING SUPPLIES COPPER, BRASS, MAL IRON - Competitive Sealed Bids - PIN#64250,1 - Due 11-3-16 at 10:30 A.M.

Interested firms are invited to obtain a copy on NYCHA's website. To conduct a search for the RFQ number; vendors are instructed to open the link: <http://www1.nyc.gov/site/nycha/business/isupplier-vendor-registration.page>. Once on that page, make a selection from the first three links highlighted in red: New suppliers for those who have never registered with iSupplier, current NYCHA suppliers and vendors for those who have supplied goods or services to NYCHA in the past but never requested a login ID for iSupplier, and Login for registered suppliers if you already have an iSupplier ID and password. Once you are logged into iSupplier, select "Sourcing Supplier," then "Sourcing Homepage" and then reference the applicable RFQ PIN/solicitation number.

Suppliers electing to obtain a non-electronic paper document will be subject to a \$25 non-refundable fee; payable to NYCHA by USPS-Money Order/Certified Check only for each set of RFQ documents requested. Remit payment to NYCHA Finance Department, at 90

Church Street, 6th Floor; obtain receipt and present it to the Supply Management Procurement Group; RFQ package will be generated at the time of request.

Use the following address unless otherwise specified in notice, to secure, examine or submit bid/proposal documents, vendor pre-qualification and other forms; specifications/blueprints; other information; and for opening and reading of bids at date and time specified above.

Housing Authority, 90 Church Street, 6th Floor, New York, NY 10007. Christine Gencerelli (212) 306-6719; christine.gencerelli@nycha.nyc.gov

o13

HOUSING PRESERVATION AND DEVELOPMENT

MAINTENANCE

SOLICITATION

Construction/Construction Services

LEAD ABATEMENT SERVICES FOR HPD - MANHATTAN AND THE BRONX - Competitive Sealed Bids - PIN# 80616B0010 - Due 11-1-16 at 11:00 A.M.

Bid documents will be available commencing Thursday, October 13, 2016. Download from The City Record free of charge or obtain paper documents for a non-refundable convenience fee of \$25 per bid package, payable at time of pick-up. Acceptable forms of payment are money order or certified bank check, only. Paper documents are available Monday through Friday, excluding City holidays, between 9:00 A.M. and NOON and between 2:00 P.M. and 4:00 P.M.

A Pre-Bid Conference is scheduled for Wednesday, October 19, 2016, at 11:00 A.M., at HPD, 100 Gold Street, 6th Floor, New York, NY 10038. Attendance is NOT mandatory, but is HIGHLY encouraged.

People with disabilities requiring special accommodations to pick up solicitation documents are advised to call Brian C. Saunders at (212) 863-6590/7995, so that necessary arrangements can be made.

This contract is subject to all provisions as may be required by Federal, State and Local Statutes, Rules and Regulations.

Use the following address unless otherwise specified in notice, to secure, examine or submit bid/proposal documents, vendor pre-qualification and other forms; specifications/blueprints; other information; and for opening and reading of bids at date and time specified above.

Housing Preservation and Development, 100 Gold Street, Section 6-M, New York, NY 10038. Brian C. Saunders (212) 863-6590; contracts@hpd.nyc.gov

o13

HUMAN RESOURCES ADMINISTRATION

OFFICE OF CONTRACTS

AWARD

Human Services/Client Services

PROVISION OF TEEN RELATIONSHIP ABUSE PREVENTION PROGRAM (TEEN RAPP) - Negotiated Acquisition - Judgment required in evaluating proposals - PIN#06908X0042CNVN008 - AMT: \$1,039,089.00 - TO: Center for the Elimination of Violence in the Family, Inc., 25 Chapel Street, 9th Floor, Suite 904, Brooklyn, NY 11201. Term: 9/1/2015 - 6/30/2016

PROVISION OF ANTI-HARASSMENT TENANT PROTECTION LEGAL SERVICES PROGRAM - Competitive Sealed Proposals - Judgment required in evaluating proposals - PIN# 09616I0003003 - AMT: \$16,031,004.00 - TO: Urban Justice Center, 40 Rector Street, 9th Floor, New York, NY 10006. Term: 1/1/2016 - 6/30/2018

PROVISION OF TEEN RELATIONSHIP ABUSE PREVENTION PROGRAM (TEEN RAPP) SERVICES - Competitive Sealed Proposals - Judgment required in evaluating proposals - PIN#09615I0006003 - AMT: \$4,080,000.00 - TO: Center for the Elimination of Violence in the Family, Inc., 25 Chapel Street, 9th Floor, Suite 904, Brooklyn, NY 11201. Term: 7/1/2016 - 6/30/2019

PROVISION OF ANTI-HARASSMENT TENANT PROTECTION LEGAL SERVICES PROGRAM - Competitive Sealed Proposals - Judgment required in evaluating proposals - PIN# 09616I0003001 - AMT: \$32,062,004.00 - TO: Legal Services -

NYC, 40 Worth Street, Suite 606, New York, NY 10013. Term: 1/1/2016 - 6/30/2018

o13

Services (other than human services)

PROVIDE CONSULTANT FOR QUALITATIVE AND IMPACT EVALUATION OF ARCHES - Other - PIN#06910H071700G-8 - AMT: \$180,000.00 - TO: The Urban Institute, 2100 M Street North West, Washington, DC 20037. Term: 11/12/2015 - 12/31/2016

o13

INFORMATION TECHNOLOGY AND TELECOMMUNICATIONS

AWARD

Services (other than human services)

CITYWIDE STANDBY INFORMATION TECHNOLOGY AND TELECOMMUNICATION CONSULTING SERVICES (ITCS) - Competitive Sealed Proposals - Judgment required in evaluating proposals - PIN# 85816P0002

DoITT intends to enter into contracts with the following eight (8) vendors to provide Citywide Standby Information Technology and Telecommunication Consulting Services (ITCS):

Experis US, Inc. 100 Manpower Place, Milwaukee, WI 53212 PIN: 85816P0002001 Contract Amount: \$18,750,000

Spruce Technology, Inc. 1149 Bloomfield Avenue, Clifton, NJ 07012 PIN: 85816P0002002 Contract Amount: \$18,750,000

GCOM Software, Inc. 24 Madison Avenue Extension, Albany, NY 12203 PIN: 85816P0002003 Contract Amount: \$18,750,000

Info People Corporation 450 Seventh Avenue, Suite 1106, New York, NY 10123 PIN: 85816P0002004 Contract Amount: \$18,750,000

Kforce, Inc. 1001 East Palm Avenue, Tampa, FL 033605 PIN: 85816P0002005 Contract Amount: \$18,750,000

Teksystems, Inc. 757 Third Avenue, Suite 1202, New York, NY 10017 PIN: 85816P0002006 Contract Amount: \$18,750,000

Universal Technologies, LLC 28 Madison Avenue Extension, Albany, NY 11203 PIN: 85816P0002007 Contract Amount: \$18,750,000

Rangam Consultants, Inc. 270 Davidson Avenue, Suite 103, Somerset, NJ 08873 PIN: 85816P0002008 Contract Amount: \$18,750,000

o13

MAYOR'S OFFICE OF CRIMINAL JUSTICE

SOLICITATION

Human Services/Client Services

RNR SIMULATION TOOL NEGOTIATED ACQUISITION - Negotiated Acquisition - Judgment required in evaluating proposals - PIN# 00217N0003 - Due 10-28-16

MOCJ proposes to develop a Risk-Need-Responsivity (RNR) Simulation Tool for New York City. This tool will help the City utilize the risk-need-responsivity approach by providing administrators with access to modules that can help them implement effective screening, assessment, programs, and treatment matching (responsivity) to improve individual and system outcomes. The Risk-Needs-Responsivity Tool was developed by George Mason University (Mason) will custom-modify their existing Risk-Need-Responsivity Simulation Tool to meet the specific needs of New York City. This modification will result in the development of customized analytics and databases for New York City on top of the successful base-platform that is presently operational. Through this procurement, the City will have access to a customized online RNR Simulation Tool.

Use the following address unless otherwise specified in notice, to secure, examine or submit bid/proposal documents, vendor pre-qualification and other forms; specifications/blueprints; other information; and for opening and reading of bids at date and time specified above.

Mayor's Office of Criminal Justice, 1 Centre Street, Room 1012N, New York, NY 10007. Jeremy Cherson (646) 576-3515; Fax: (646) 576-3515; jcherson@cityhall.nyc.gov

o12-18

PARKS AND RECREATION

■ **VENDOR LIST**

Construction/Construction Services

PREQUALIFIED VENDOR LIST: GENERAL CONSTRUCTION - NON-COMPLEX GENERAL CONSTRUCTION SITE WORK ASSOCIATED WITH NEW YORK CITY DEPARTMENT OF PARKS AND RECREATION ("DPR" AND/OR "PARKS") PARKS AND PLAYGROUNDS CONSTRUCTION AND RECONSTRUCTION PROJECTS

DPR is seeking to evaluate and pre-qualify a list of general contractors (a "PQL") exclusively to conduct non-complex general construction site work involving the construction and reconstruction of DPR parks and playgrounds projects not exceeding \$3 million per contract ("General Construction").

By establishing contractor's qualification and experience in advance, DPR will have a pool of competent contractors from which it can draw to promptly and effectively reconstruct and construction its parks, playgrounds, beaches, gardens and green-streets. DPR will select contractors from the General Construction PQL for non-complex general construction site work of up to \$3,000,000.00 per contract, through the use of a Competitive Sealed Bid solicited from the PQL generated from this RFQ.

The vendors selected for inclusion in the General Construction PQL will be invited to participate in the NYC Construction Mentorship. NYC Construction Mentorship focuses on increasing the use of small NYC contracts, and winning larger contracts with larger values. Firms participating in NYC Construction Mentorship will have the opportunity to take management classes and receive on-the-job training provided by a construction management firm.

DPR will only consider applications for this General Construction PQL from contractors who meet any one of the following criteria:

- 1) The submitting entity must be a Certified Minority/Woman Business enterprise (M/WBE)*;
- 2) The submitting entity must be a registered joint venture or have a valid legal agreement as a joint venture, with at least one of the entities in the joint venture being a certified M/WBE*;
- 3) The submitting entity must indicate a commitment to sub-contract no less than 50 percent of any awarded job to a certified M/WBE for every work order awarded.

*Firms that are in the process of becoming a New York City-Certified M/WBE may submit a PQL application and submit a M/WBE Acknowledgement Letter, which states the Department of Small Business Services has began the Certification process.

Application documents may also be obtained on-line at: <http://a856-internet.nyc.gov/nycvendoronline/home.asap.>; or <http://www.nycgovparks.org/opportunities/business>

Use the following address unless otherwise specified in notice, to secure, examine or submit bid/proposal documents, vendor pre-qualification and other forms; specifications/blueprints; other information; and for opening and reading of bids at date and time specified above.

Parks and Recreation, Olmsted Center, Annex, Flushing Meadows-Corona Park, Flushing, NY 11368. Alicia H. Williams (718) 760-6925; Fax: (718) 760-6781; dmwbe.capital@parks.nyc.gov

j4-d30

REVENUE

■ **SOLICITATION**

Services (other than human services)

RENOVATION, OPERATION, AND MAINTENANCE OF A PARKING LOT - Competitive Sealed Proposals - Judgment required in evaluating proposals - PIN#X39-B-PL-2016 - Due 12-1-16 at 3:00 P.M.

at Orchard Beach, Pelham Bay Park, The Bronx.

There will be a recommended site visit on Friday, October 28, 2016, at 12:00 P.M. We will be meeting in front of the toll booths at the parking lot at Orchard Beach, Pelham Bay Park, The Bronx. If you are considering responding to this RFP, please make every effort to attend this recommended site visit.

The RFP is also available for download, commencing on October 12, 2016 through December 1, 2016, on Parks' website. To download the RFP, visit www.nyc.gov/parks/businessopportunities, click on the link for "Concessions Opportunities at Parks" and, after logging in, click on the "download" link that appears adjacent to the RFP's description.

Use the following address unless otherwise specified in notice, to secure, examine or submit bid/proposal documents, vendor pre-qualification and other forms; specifications/blueprints; other information; and for opening and reading of bids at date and time specified above.

Parks and Recreation, The Arsenal, Central Park, 830 Fifth Avenue, Room 407, New York, NY 10065. Danielle Seeley (212) 360-3407; Fax: (917) 849-6653; danielle.seeley@parks.nyc.gov

Accessibility questions: For inquiries, Please call: (212) 360-3407. Telecommunication Device for the Deaf (TDD): (212) 504-4115, by: Tuesday, November 29, 2016, 3:00 P.M.



o12-25

FOR THE OPERATION OF A FREE CONCERT SERIES AND A MAXIMUM OF SIX (6) KIOSKS - Competitive Sealed Proposals - Judgment required in evaluating proposals - PIN#X39-CON-O-2016 - Due 12-1-16 at 3:00 P.M.

for the Operation of a Free Concert Series and a Maximum of Six (6) Kiosks at Orchard Beach, Pelham Bay Park.

There will be a recommended site visit on Thursday, October 27, 2016, at 2:00 P.M. We will be meeting in Room 407 of the Arsenal, which is located at, 830 5th Avenue, in Central Park, Manhattan. If you are considering responding to this RFP, please make every effort to attend this recommended site visit.

The RFP is also available for download, commencing on October 12, 2016 through December 1, 2016, on Parks' website. To download the RFP, visit www.nyc.gov/parks/businessopportunities, click on the link for "Concessions Opportunities at Parks" and, after logging in, click on the "download" link that appears adjacent to the RFP's description.

Use the following address unless otherwise specified in notice, to secure, examine or submit bid/proposal documents, vendor pre-qualification and other forms; specifications/blueprints; other information; and for opening and reading of bids at date and time specified above.

Parks and Recreation, The Arsenal, Central Park, 830 Fifth Avenue, Room 407, New York, NY 10065. Danielle Seeley (212) 360-3407; Fax: (917) 849-6653; danielle.seeley@parks.nyc.gov

Accessibility questions: For inquiries, please call: (212) 360-3407. Telecommunication Device for the Deaf (TDD): (212) 504-4115, by: Tuesday, November 29, 2016, 3:00 P.M.



o12-25

SANITATION

AGENCY CHIEF CONTRACTING OFFICER

■ **SOLICITATION**

Construction/Construction Services

QUEENS CENTRAL REPAIR SHOP FLOOR SLAB REHABILITATION AT 52-35 58TH STREET, WOODSIDE, QUEENS, NY 11377 - Competitive Sealed Bids - PIN#82716RR00026 - Due 11-17-16 at 11:00 A.M.

Bid Estimate – \$2,550,855.00. There is a \$80.00 refundable fee for this bid document, postal money order only accepted, please make payable to "Comptroller, City of New York."

Pre-Bid Conference will be held on October 27, 2016, at 1:30 P.M., at 44 Beaver Street, 12th Floor Conference Room, New York, NY 10004. Last day for questions is 11/4/16, at 3:00 P.M., please contact Frank Mitchell at (212) 437-4542, or email at fmitchell@dsny.nyc.gov.

In accordance with Schedule A of the bid document, if your bid is over \$1,000,000, you must submit a certified check or money order equal to 5 percent of the Bid amount or Bid Bond with Penal Sum equal to 10 percent of the Bid amount. This Procurement is subject to MWBE Local Law 1 of 2013. There is a 28 percent MWBE goal. This Procurement is Subject to a Project Labor Agreement (PLA)

VSID # 90996

Use the following address unless otherwise specified in notice, to secure, examine or submit bid/proposal documents, vendor pre-qualification and other forms; specifications/blueprints; other information; and for opening and reading of bids at date and time specified above.

Sanitation, 44 Beaver Street, Room 203, New York, NY 10004. Agency Chief Contracting Office (212) 437-5057.

Accessibility questions: Frank Mitchell (212) 437-4542, by: Thursday, October 27, 2016, 1:30 P.M.



o13

TRANSPORTATION

TRAFFIC

INTENT TO AWARD

Services (other than human services)

MUNI-METERS AND ANCILLARY SOFTWARE - Sole Source - Available only from a single source - PIN#84117MBTR053 - Due 10-25-16 at 2:00 P.M.

The New York City Department of Transportation (DOT) intends to enter into a sole source agreement with Parkeon, Inc., to purchase multi-space muni-meter parts, and support services for the current 14,300 electronic multi-space muni-meters supplied by Parkeon, Inc. and installed Citywide. Parkeon, Inc. provides equipment and communications from DOT's meters to process live credit card transactions, back office support and data management, reporting, programming and spare parts for these electronic multi-space parking meters.

It is a fully managed solution for DOT, a networked system that communicates with Parkeon, Inc.'s proprietary infrastructure using Parkeon, Inc.'s encrypted proprietary software. Based on the foregoing, on September 30, 2016 the Agency Chief Contracting Officer's Office determined, in accordance with Section 3-05(b) of the Procurement Policy Board Rules, that Parkeon, Inc. is the only vendor able to supply the needed parts compatible with DOT's meters which enable communications and provide data needed to manage the City's meters on the first day of a new contract term.

Vendors may express interest in providing this service by contacting David Maco, New York Department of Transportation, Agency Chief Contracting Officer's Office, 55 Water Street, 8th Floor, New York, NY 10041, at (212) 839-9400, no later than October 25, 2016, at 2:00 P.M.

Use the following address unless otherwise specified in notice, to secure, examine or submit bid/proposal documents, vendor pre-qualification and other forms; specifications/blueprints; other information; and for opening and reading of bids at date and time specified above.

Transportation, Agency Chief Contracting Officer's Office, 55 Water Street, 8th Floor, New York, NY 10041. Bid Window (212) 839-9400.

07-14

AGENCY RULES

ENVIRONMENTAL PROTECTION

NOTICE

Notice of Public Hearing and Opportunity to Comment on Amended Proposed Rules

What are we proposing? The Department of Environmental Protection is issuing rules that establish requirements for stack tests and smoke tests to measure smoke emissions from generators with an output of 40 kilowatts or more.

When and where is the hearing? The department will hold a public hearing on the proposed rule. The public hearing will take place at 10:00 A.M., on November 16, 2016. The hearing will be held in the 9th Floor Conference Room, at 59-17 Junction Boulevard, Flushing, NY 11373. The prior hearing was held on August 10, 2016.

How do I comment on the proposed rules? Anyone can comment on the proposed rules by:

- Website. You can submit comments to the Department of Environmental Protection through the NYC rules website at http://rules.cityofnewyork.us.
Email. You can email written comments to nycrules@dep.nyc.gov.

- Mail. You can mail written comments to the Department of Environmental Protection, Bureau of Legal Affairs, 59-17 Junction Boulevard, 19th Floor, Flushing, NY 11373.
Fax. You can fax written comments to the Department of Environmental Protection, Bureau of Legal Affairs, at (718) 595-6543.
By speaking at the hearing. Anyone who wants to comment on the proposed rule at the public hearing must sign up to speak. You can sign up before the hearing by calling (718) 595-6531. You can also sign up in the hearing room before the hearing begins on November 16, 2016. You can speak for up to three minutes.

Is there a deadline to submit written comments? Yes, you must submit written comments by November 16, 2016.

Do you need assistance to participate in the hearing? You must tell the Bureau of Legal Affairs if you need a reasonable accommodation of a disability at the hearing. You must tell us if you need a sign language interpreter. You can tell us by mail at the address given above. You may also tell us by telephone at (718) 595-6531. You must tell us by November 9, 2016.

Can I review the comments made on the proposed rules? You can review the comments made online on the proposed rules by going to the website at http://rules.cityofnewyork.us/. A few days after the hearing, a transcript of the hearing and copies of the written comments will be available to the public at the Bureau of Legal Affairs.

What authorizes the department to make this rule? Section 1043 of the City Charter and Sections 24-105, 24-109(c)(2)(i), and 24-125(a) (1) of the Administrative Code authorize the department to make this proposed rule. This proposed rule was included in the department's regulatory agenda for this fiscal year.

Where can I find the department's rules? The department's rules are in Title 15 of the Rules of the City of New York.

What rules govern the rulemaking process? The department must meet the requirements of Section 1043(c) of the City Charter when creating or changing rules. This notice is made according to the requirements of Section 1043(b) of the City Charter.

Statement of Basis and Purpose of Proposed Rule

This rule defines the method that must be used in performing a smoke test or stack test for generators with an output of 40 kilowatts or more.

Local Law Number 38 for the year 2015 amends Title 24 of the Administrative Code of the City of New York. It defines required procedures that a Professional Engineer (P.E.) or Registered Architect (R.A.) must follow in order to certify that any generator with an output of 40 kilowatts or more has passed a stack test. This rule only sets forth the test method that a P.E. or R.A. shall follow if a Method 9, "Visual determination of the opacity of emissions from stationary sources" test is not used to meet the requirements set forth in Section 24-109(c)(2)(i).

Section 24-109(c)(2)(i) specifically requires the Department to establish by rule a method for the stack test that generators must pass before registration of the generator that may be used instead of conducting a Method 9 test. This rule also meets the requirement set forth in Section 24-125(a) that requires the Department to issue a rule that establishes criteria that must be met prior to a work permit being granted for any equipment, including a generator.

DEP has clarified the requirements and standards required in this rule based on comments received at the hearing and in writing. Comments that were submitted that pertained to Code requirements, including but not limited to what types of generators need to obtain a registration or work permit and certificate of operation, are not addressed by this rule as these requirements have already been affirmatively provided for in the Air Pollution Control Code.

The Rule is authorized by Section 1043 of the Charter and Section 24-105 24-109(c)(2)(i), and 24-125(a)(1) of the Administrative Code.

The text of the Rule follows.

Section 1. Section 1. Title 15 of the Rules of the City of New York is amended by adding a new Chapter 44, to read as follows:

New material is underlined.
[Deleted material is in brackets.]

"Shall" and "must" denote mandatory requirements and may be used interchangeably in the rules of this department, unless otherwise specified or unless the context clearly indicates otherwise.

Chapter 44

Standard Test Procedures to Determine Smoke Emissions from Generators with an Output of 40 kw or More

44-01 Definitions

“Generator” means any internal combustion engine that operates as a mechanical or electrical power source.

“Kilowatt” means a unit of electrical power equal to one thousand watts.

44-02 Test Procedures

(a) Exemptions

The following generators are not subject to this rule’s testing requirements: Generators that are (1) certified Tier IV as set forth in table one of Section 1039.101 of Title 40 of the code of Federal regulations or any subsequent United States environmental protection agency, and (2) newly installed and being registered for the first time.

(b) Test Procedures

All generators that are subject to the test requirements of this rule must be tested in accordance with the procedures set forth in paragraph (1) or (2) below.

(1) Stack Test Procedure

- (a) Generators must meet equivalent Tier IV particulate matter (PM) emissions standards established by the United States Environmental Protection Agency (EPA) as set forth in table one of Section 1039.101 of Title 40 of the code of federal regulations or any subsequent United States EPA emissions standard for such generator that is at least as stringent.
- (b) In order to demonstrate that the PM emissions from the stack of a generator meet the Tier IV PM emissions standard, testing must be performed by the equipment owner following EPA Method 5, titled “Determination of particulate matter emissions from stationary sources” (Appendix A-3 to part 60 of Title 40 of the code of Federal regulations). The P.E. or R.A. must certify the stack test results.

(2) Smoke Test Procedure

A smoke test on a generator shall be performed in accordance with the procedures set forth in EPA Method 9, titled “Visual determination of the opacity of emissions from stationary sources” (Appendix A-4 to part 60 of Title 40 of the code of Federal regulations). The test results shall indicate less than 20 percent opacity for any two consecutive minutes in any 60-minute period. The smoke test must be performed and certified by a qualified visible emissions evaluator.

(c) Recordkeeping

- (1) For generators that require a registration under Section 24-109 of the administrative code (those stationary generators with an output from 40 kw to less than 450 kw and all emergency and portable generators with an output of 40 KW or greater), proof that the generator passed either a stack test using EPA Method 5 or a smoke test using EPA Method 9 must be submitted to the department upon request.
- (2) For generators that require a certificate of operation under Section 24-122 of the administrative code (those with an output of 450 kw or more), proof that the generator passed either a stack test using EPA Method 5 or a smoke test using EPA Method 9 must be submitted to the department with the application for an original inspection request to obtain the Certificate of Operation.
- (3) Records of tests required by this rule shall be maintained by the equipment owner for five years.

NEW YORK CITY LAW DEPARTMENT
DIVISION OF LEGAL COUNSEL
100 CHURCH STREET
NEW YORK, NY 10007
(212) 356-4028

CERTIFICATION PURSUANT TO
CHARTER §1043(d)

RULE TITLE: Measurement of Stack Emissions of Certain Generators

REFERENCE NUMBER: 2016 RG 077

RULEMAKING AGENCY: New York City Department of Environmental Protection

I certify that this office has reviewed the above-referenced proposed rule as required by Section 1043(d) of the New York City Charter, and that the above-referenced proposed rule:

- (i) is drafted so as to accomplish the purpose of the authorizing provisions of law;
- (ii) is not in conflict with other applicable rules;
- (iii) to the extent practicable and appropriate, is narrowly drawn to achieve its stated purpose; and
- (iv) to the extent practicable and appropriate, contains a statement of basis and purpose that provides a clear explanation of the rule and the requirements imposed by the rule.

/s/ STEVEN GOULDEN
Acting Corporation Counsel

Date: October 5, 2016

NEW YORK CITY MAYOR’S OFFICE OF OPERATIONS
253 BROADWAY, 10th FLOOR
NEW YORK, NY 10007
(212) 788-1400

CERTIFICATION/ANALYSIS
PURSUANT TO CHARTER SECTION 1043(d)

RULE TITLE: Measurement of Stack Emissions of Certain Generators

REFERENCE NUMBER: DEP-28

RULEMAKING AGENCY: New York City Department of Environmental Protection

I certify that this office has analyzed the proposed rule referenced above as required by Section 1043(d) of the New York City Charter, and that the proposed rule referenced above:

- (i) Is understandable and written in plain language for the discrete regulated community or communities;
- (ii) Minimizes compliance costs for the discrete regulated community or communities consistent with achieving the stated purpose of the rule; and
- (iii) Does not provide a cure period because it does not establish a violation, modification of a violation, or modification of the penalties associated with a violation.

/s/ [Stephen Narloch]
Mayor’s Office of Operations

[October 5, 2016]
Date



o13



CITY PLANNING

■ NOTICE

THE CITY OF NEW YORK
THE DEPARTMENT OF CITY PLANNING
THE DEPARTMENT OF HOUSING PRESERVATION AND DEVELOPMENT
NOTICE OF PROPOSED SUBSTANTIAL AMENDMENT TO THE 2015 CONSOLIDATED PLAN ONE-YEAR ACTION PLAN

TO ALL INTERESTED AGENCIES, COMMUNITY BOARDS, GROUPS, AND PERSONS:

In accordance with 24 CFR 91.505 of the U.S. Department of Housing and Urban Development (HUD) Consolidated Plan regulations regarding amendments, the City of New York announces the public comment period for the substantial amendment to the City’s 2015 Consolidated Plan One-Year Action Plan HOME Investment Partnerships (HOME) programmatic activities.

The public comment period will begin on October 12, 2016 and extend thirty (30) days to November 10, 2016.

The amendment to New York City’s 2015 HOME-funded activities entails the reallocation of funds between two existing programs: the HOME Tenant-Based Rental Assistance Program (HOME TBRA) and the HOME-funded Supportive Housing Program (SHP). The

amendment also revises the proposed accomplishments for each program reflective of the reallocation of funds. Specifically, the amendment shows that \$17,000,000 of HOME TBRA funding will be transferred to the SHP to support additional new construction projects for affordable housing units. \$3,000,000 of the originally allocated \$20,000,000 in the City's 2015 HOME Program funding remains with the TBRA program, better reflecting the needs of the overall 2015 HOME Program Year (Calendar 2015).

Copies of the amended 2015 Consolidated Plan One-Year Action Plan - Addendum: HOME Investment Partnerships Program will be made available on October 12, 2016 and can be obtained at the Department of City Planning Bookstore, 120 Broadway, 31st Floor, New York, NY 10271 (Mondays 10:00 A.M. until 12:00 NOON with walk-ins from 10:00 A.M. until 11:00 A.M., and Wednesdays from 1:00 P.M. until 3:00 P.M. with walk ins from 2:00 P.M. until 3:00 P.M.). In addition, the Addendum can be downloaded through the internet via the Department's website at www.nyc.gov/planning.

Written comments on the proposed changes should be sent by close of business November 10, 2016 to: Charles V. Sorrentino, Consolidated Plan Coordinator, 120 Broadway, 31st Floor, New York, NY 10271. email: Con-PlanNYC@planning.nyc.gov.

The City of New York: Bill de Blasio, Mayor
Carl Weisbrod, Director, Department of City Planning
Vicki Been, Commissioner, Department of Housing Preservation and Development

o11-24

**THE CITY OF NEW YORK
THE DEPARTMENT OF CITY PLANNING
THE DEPARTMENT OF HOUSING PRESERVATION AND DEVELOPMENT
NOTICE OF PROPOSED SUBSTANTIAL AMENDMENT
TO THE 2016 CONSOLIDATED PLAN
ONE-YEAR ACTION PLAN**

TO ALL INTERESTED AGENCIES, COMMUNITY BOARDS, GROUPS, AND PERSONS:

In accordance with 24 CFR 91.505 of the U.S. Department of Housing and Urban Development (HUD) Consolidated Plan regulations regarding amendments, the City of New York announces the public comment period for the substantial amendment to the City's 2016 Consolidated Plan One-Year Action Plan HOME Investment Partnerships (HOME) programmatic activities.

The public comment period will begin on October 12, 2016 and extend thirty (30) days to November 10, 2016.

The amendment to New York City's 2016 HOME-funded activities entails the creation of a new program - HOME Tenant-Based Rental Assistance Program (HOME TBRA). The new program will be funded with \$5,000,000 reallocated from the City's 2016 HOME-funded Supportive Housing Program (SHP). The amendment also revises the proposed accomplishments for the existing SHP, reflective of the reallocation of funds.

Copies of the amended 2016 Consolidated Plan - Addendum: HOME Investment Partnerships will be made available on October 12, 2016 and can be obtained at the Department of City Planning Bookstore, 120 Broadway, 31st Floor, New York, NY 10271 (Mondays 10:00 A.M. until 12:00 NOON with walk-ins from 10:00 A.M. until 11:00 A.M., and Wednesdays from 1:00 P.M. until 3:00 P.M., with walk ins from 2:00 P.M. until 3:00 P.M.). In addition, the Addendum can be downloaded through the internet via the Department's website at www.nyc.gov/planning.

Written comments on the proposed changes should be sent by close of business November 10, 2016 to: Charles V. Sorrentino, Consolidated Plan Coordinator, 120 Broadway, 31st Floor, New York, NY 10271. email: Con-PlanNYC@planning.nyc.gov.

The City of New York: Bill de Blasio, Mayor
Carl Weisbrod, Director, Department of City Planning
Vicki Been, Commissioner, Department of Housing Preservation and Development

o11-24

HOUSING PRESERVATION AND DEVELOPMENT

■ NOTICE

**REQUEST FOR COMMENT
REGARDING AN APPLICATION FOR A
CERTIFICATION OF NO HARASSMENT**

Notice Date: October 12, 2016

To: Occupants, Former Occupants, and Other Interested Parties

Property:	Address	Application #	Inquiry Period
	638 West 158 th Street, Manhattan	126/16	September 1, 2013 to Present
	43 East 92 nd Street, Manhattan	127/16	September 1, 2013 to Present
	a/k/a 1295 Madison Avenue		
	244 West 18 th Street, Manhattan	128/16	September 1, 2013 to Present
	111 West 130 th Street, Manhattan	129/16	September 2, 2013 to Present
	429 West 162 nd Street, Manhattan	131/16	September 6, 2013 to Present
	117 West 79 th Street, Manhattan	135/16	September 13, 2013 to Present
	116 West 118 th Street, Manhattan	138/16	September 22, 2013 to Present
	10 East 128 th Street, Manhattan	140/16	September 26, 2013 to Present
	532 West 148 th Street, Manhattan	141/16	September 26, 2013 to Present
	469 West 147 th Street, Manhattan	143/16	September 29, 2013 to Present
	133 Fort Greene Place, Brooklyn	130/16	September 2, 2013 to Present
	212A Macon Street, Brooklyn	133/16	September 12, 2013 to Present
	533 Quincy Street, Brooklyn	134/16	September 13, 2013 to Present
	290 Jefferson Avenue, Brooklyn	136/16	September 15, 2013 to Present
	716 Marcy Avenue, Brooklyn	137/16	September 16, 2013 to Present
	580 St. Marks Avenue, Brooklyn	139/16	September 22, 2013 to Present
	375 Sterling Place, Brooklyn	142/16	September 28, 2013 to Present
	179 Beach 115 th Street, Queens	132/16	September 7, 2013 to Present

Authority: SRO, Administrative Code §27-2093

Before the Department of Buildings can issue a permit for the alteration or demolition of a single room occupancy multiple dwelling, the owner must obtain a "Certification of No Harassment" from the Department of Housing Preservation and Development ("HPD") stating that there has not been harassment of the building's lawful occupants during a specified time period. Harassment is conduct by an owner that is intended to cause, or does cause, residents to leave or otherwise surrender any of their legal occupancy rights. It can include, but is not limited to, failure to provide essential services (such as heat, water, gas, or electricity), illegally locking out building residents, starting frivolous lawsuits, and using threats or physical force.

The owner of the building identified above has applied for a Certification of No Harassment. If you have any comments or evidence of harassment at this building, please notify HPD at **CONH Unit, 100 Gold Street, 6th Floor, New York, NY 10038** by letter postmarked not later than 30 days from the date of this notice or by an in-person statement made within the same period. To schedule an appointment for an in-person statement, please call **(212) 863-5277 or (212) 863-8211**.

o12-20

MAYOR'S OFFICE OF CONTRACT SERVICES

■ NOTICE

Notice of Intent to Issue New Solicitation(s) Not Included in FY 2017 Annual Contracting Plan and Schedule

NOTICE IS HEREBY GIVEN that the Mayor will be issuing the following solicitation(s) not included in the FY 2017 Annual Contracting Plan and Schedule that is published pursuant to New York City Charter § 312(a):

Agency: New York City Emergency Management (NYCEM)
 Description of services sought: Third-Party logistics Services
 Start date of the proposed contract: December 1, 2016
 End date of the proposed contract: November 30, 2017
 Method of solicitation the agency intends to utilize: Negotiated Acquisition Extension (NAE)
 Personnel in substantially similar titles within agency: None
 Headcount of personnel in substantially similar titles within agency: 0

◀ o13

CHANGES IN PERSONNEL

DEPT OF HEALTH/MENTAL HYGIENE
FOR PERIOD ENDING 09/09/16

NAME		TITLE	NUM	SALARY	ACTION	PROV	EFF DATE	AGENCY
ABRAMS	CRYSTAL	L	31215	\$41199.0000	APPOINTED	YES	08/21/16	816
ADAMS	APRIL	A	51195	\$19.2800	APPOINTED	YES	08/21/16	816
ALEX	BYRON	T	53039	\$108621.0000	APPOINTED	YES	08/28/16	816
ALEXANDER	GEM	C	56058	\$70000.0000	APPOINTED	YES	08/21/16	816
ALEXIS	JOANNE	T	1002F	\$99181.0000	INCREASE	YES	08/07/16	816
ARIAS-DIAZ	EVELYN	K	83052	\$67307.0000	RESIGNED	YES	09/01/16	816
ARTHUR	ROXANNE	S	52613	\$53643.0000	APPOINTED	YES	08/21/16	816
ATTREED	MATTHEW	T	21849	\$59589.0000	APPOINTED	YES	08/21/16	816
BAERGA	JENNIFER		81815	\$18.2600	APPOINTED	NO	08/28/16	816
BAILEY	HAROLD		31121	\$62061.0000	RETIRED	YES	09/01/16	816
BAILEY	HAROLD		70817	\$57846.0000	RETIRED	NO	09/01/16	816
BAPTISTE	SAFIYA	A	56058	\$62400.0000	RESIGNED	YES	08/21/16	816
BARON	REBECCA	E	1002A	\$61031.0000	RESIGNED	YES	08/23/16	816
BARRIOS	YASMIN	V	10232	\$20.5900	RESIGNED	YES	08/21/16	816
BRAHWAITTE	CHANTELLE	A	1002F	\$73004.0000	INCREASE	YES	08/07/16	816
BROWN	FELICIA		81815	\$15.8300	APPOINTED	YES	08/21/16	816
BROWN	FRANCINE	M	83052	\$51177.0000	APPOINTED	YES	08/21/16	816
BYNUM	MERCEDES	K	81815	\$15.8300	APPOINTED	YES	08/21/16	816
CATANIA	HOLLY		21744	\$110000.0000	APPOINTED	YES	08/28/16	816
CESPEDES	OLIVER	A	70810	\$34666.0000	RESIGNED	NO	08/28/16	816
CHAN	KRISTEN	D	21849	\$59589.0000	APPOINTED	YES	08/21/16	816
CHEN	WINNIE	Y	10095	\$91873.0000	INCREASE	YES	08/21/16	816
CHRIST	KELLY	C	51191	\$54142.0000	RESIGNED	NO	08/28/16	816

DEPT OF HEALTH/MENTAL HYGIENE
FOR PERIOD ENDING 09/09/16

NAME		TITLE	NUM	SALARY	ACTION	PROV	EFF DATE	AGENCY
CLARKE	RYAN	P	21849	\$59589.0000	APPOINTED	YES	08/21/16	816
COFER	RENEE	M	12158	\$82245.0000	INCREASE	YES	08/07/16	816
COLON	JACQUELI		12158	\$40.0000	INCREASE	YES	08/07/16	816
COOPER-LUCAS	ESTHER		83052	\$68322.0000	RETIRED	YES	09/01/16	816
COOPER-LUCAS	ESTHER		52613	\$61233.0000	RETIRED	NO	09/01/16	816
CORREA	MARIA		12158	\$52979.0000	INCREASE	NO	08/28/16	816
CRAWFORD	CHRISTOP	G	21744	\$99700.0000	APPOINTED	YES	08/21/16	816
CRIBBS	KRISTEN	A	10209	\$13.9000	RESIGNED	YES	08/28/16	816
CRUZ	ELIZABET		56056	\$30273.0000	APPOINTED	YES	08/21/16	816
CUFF	YVETTE		06611	\$97780.0000	APPOINTED	YES	08/21/16	816
DARABSEH	ALAA	I	13631	\$64807.0000	APPOINTED	YES	08/28/16	816
DAVIDSON	ANTHONY		21513	\$48166.0000	INCREASE	YES	08/21/16	816
DAVIDSON	ANTHONY		21512	\$44598.0000	APPOINTED	NO	08/21/16	816
DAVIDSON	GEORGIA	K	21744	\$110971.0000	RETIRED	YES	09/02/16	816
DAVIDSON	GEORGIA	K	12627	\$73389.0000	RETIRED	NO	09/02/16	816
DAVIS	CHAUNTE	E	81815	\$15.8300	APPOINTED	YES	08/21/16	816
DELVILLAR	MARIA	D	51611	\$69056.0000	RETIRED	NO	09/01/16	816
DESROSIERS	KIMBERLY		51195	\$19.2800	APPOINTED	YES	08/21/16	816
DOMENECH	JAHNNA	A	51022	\$31.5500	RESIGNED	YES	08/28/16	816
DRAGICH	AUDREY	J	5100B	\$31.2900	DECEASED	YES	08/28/16	816
EISENBERG	HARVEY		53040	\$89.5400	RESIGNED	YES	08/30/16	816
EVANS	PATRICIA	B	5100B	\$31.2900	RETIRED	YES	09/02/16	816
FREEMAN	MILLICEN	L	56058	\$73484.0000	INCREASE	YES	08/07/16	816
GANDHI	ANISHA	D	21744	\$76340.0000	APPOINTED	YES	08/28/16	816
GEEVARUGHSE	ANITA		5304B	\$153340.0000	INCREASE	YES	08/28/16	816
GONZALEZ	ESTELA		51110	\$53678.0000	APPOINTED	NO	03/06/16	816
GONZALEZ	MARIO	L	10010	\$96000.0000	APPOINTED	YES	08/28/16	816
GORTCHAKOVA	NATALIA		5100B	\$31.2900	RESIGNED	YES	08/28/16	816
GRAHAM	CHANIQUA	F	21512	\$38432.0000	RESIGNED	NO	08/14/16	816
GRANT	JESSICA	D	5100B	\$31.2900	RESIGNED	YES	08/28/16	816
GREENIDGE	PETRONA	S	81815	\$15.8300	APPOINTED	YES	08/21/16	816
GUIDA	FRANCESC		51195	\$19.2800	APPOINTED	YES	08/21/16	816
GUNTHORPE	MAUREL	E	51022	\$31.5500	RETIRED	YES	09/02/16	816
HAMILTON	CAPUCINE	D	8297A	\$83462.0000	INCREASE	YES	08/07/16	816
HAND	STEVEN	M	21849	\$59589.0000	APPOINTED	YES	08/21/16	816
HAQUE	FATEMA	Y	51181	\$58473.0000	INCREASE	YES	08/21/16	816
HAQUE	FATEMA	Y	51191	\$54142.0000	APPOINTED	NO	08/21/16	816
HARDING	ADRIANNE	S	5100B	\$31.2900	RESIGNED	YES	08/28/16	816
HARDING	ERIKA		51190	\$34784.0000	RESIGNED	YES	08/28/16	816
HARRIS	SHELLA		21512	\$41184.0000	RETIRED	NO	09/02/16	816
HAWKINS	SHEPERIO	J	91232	\$52397.0000	RETIRED	NO	09/01/16	816
HENDRICKS	ASATA	E	10209	\$9.6000	RESIGNED	YES	08/30/15	816
HENRY	GARY		56058	\$75900.0000	INCREASE	YES	08/07/16	816
HILLS	KATHLEEN	J	81815	\$15.8300	APPOINTED	YES	08/21/16	816
HOLLAND	VALERIE	E	1002C	\$107485.0000	INCREASE	NO	08/28/16	816
HOOD	GRACE	I	10232	\$20.5900	RESIGNED	YES	08/21/16	816

HSIEH	VICTORIA	G	21849	\$49796.0000	APPOINTED	YES	08/21/16	816
HUIE	ERIN	L	10056	\$80000.0000	APPOINTED	YES	08/28/16	816
HUNTER	JAMES	H	52613	\$46163.0000	RESIGNED	NO	08/21/16	816
HYNES	JOSEPH	E	21849	\$25.6500	APPOINTED	YES	08/21/16	816
ISNORA	PERALT	O	51195	\$19.2800	APPOINTED	YES	08/28/16	816

DEPT OF HEALTH/MENTAL HYGIENE
FOR PERIOD ENDING 09/09/16

NAME		TITLE	NUM	SALARY	ACTION	PROV	EFF DATE	AGENCY
IUPPA	ELIZABET	G	21744	\$57969.0000	APPOINTED	YES	08/28/16	816
JACOBS	JEAN	S	12626	\$72642.0000	RETIRED	NO	09/01/16	816
JENKINS	LISA	M	53040	\$71.2300	APPOINTED	YES	08/21/16	816
JOHN	GWENDOLY		81805	\$33298.0000	RETIRED	NO	09/02/16	816
JOHNSON	ERICA	N	21849	\$49796.0000	APPOINTED	YES	08/21/16	816
JOSEPH	BRITANY	A	81815	\$15.8300	APPOINTED	YES	08/21/16	816
KHAN	RIBEN		10209	\$11.5000	RESIGNED	YES	08/21/16	816
KIM	WOO YONG		5100B	\$31.2900	RESIGNED	YES	08/28/16	816
KINNA	EMMA	A	21849	\$59589.0000	INCREASE	YES	08/21/16	816
KONIG	JASON	C	51195	\$19.2800	APPOINTED	YES	08/28/16	816
LAM	JENNY		31215	\$41199.0000	APPOINTED	YES	08/21/16	816
LASNER-FRATER	LARA	B	10251	\$56775.0000	RESIGNED	NO	08/17/16	816
LEE	EMILY	J	10209	\$10.6000	RESIGNED	YES	08/21/16	816
LI	SHUYI		40526	\$55144.0000	INCREASE	NO	08/21/16	816
LIEBMAN	EMMA	R	10234	\$12.3900	RESIGNED	YES	08/21/16	816
LIEW	KWOCK	F	21538	\$55015.0000	APPOINTED	YES	08/21/16	816
LIGGIO	KATHLEEN	E	53299	\$78464.0000	APPOINTED	YES	08/21/16	816
LITVAK	JACQUELI	J	10232	\$20.5900	RESIGNED	YES	08/21/16	816
LIU	BOVEN		12158	\$88945.0000	APPOINTED	NO	08/07/16	816
LOPEZ	JOELLE	A	21849	\$49796.0000	APPOINTED	YES	08/21/16	816
LOWE	KAMECA	A	51195	\$19.2800	APPOINTED	YES	08/21/16	816
LU	KATRINA	B	10209	\$11.5000	RESIGNED	YES	08/28/16	816
LUCIANY	ELIZABET	M	10251	\$30580.0000	APPOINTED	NO	08/21/16	816
LUNDI	ELIZABET	T	06316	\$65000.0000	APPOINTED	YES	08/21/16	816
LURIE	ELIZABET	A	21744	\$68239.0000	RESIGNED	YES	08/31/16	816
MANTUS	MOLLY	R	10234	\$12.3900	RESIGNED	YES	08/21/16	816
MARTIN	MARIEKE	B	81815	\$15.8300	RESIGNED	YES	08/28/16	816
MARTINEZ	JORGE		30087	\$110186.0000	INCREASE	YES	08/21/16	816
MCCANN	DAVID	T	10095	\$138685.0000	INCREASE	YES	09/01/16	816
MCCRIGHT	SADIA	L	82107	\$37584.0000	APPOINTED	YES	08/21/16	816
MCKNIGHT	DEWAYNE	E	12158	\$85284.0000	INCREASE	NO	08/14/16	816
MCLBE	JADE	C	21744	\$57969.0000	APPOINTED	YES	08/28/16	816
MEHLMAN	YONATAN		10209	\$10.0000	RESIGNED	YES	08/21/16	816
MEJIA	DIEGO	F	60910	\$62148.0000	APPOINTED	NO	08/21/16	816
MELITO	STEPHEN	J	53859	\$131556.0000	RESIGNED	YES	09/02/16	816
MELGORIMO	JOSEPH	M	21849	\$49796.0000	APPOINTED	YES	08/21/16	816
MILLICAN	MICHAEL	M	56058	\$64820.0000	APPOINTED	YES	08/28/16	816
MINHAS	HARJIT	S	40510	\$65000.0000	APPOINTED	YES	08/21/16	816
MOHSIN	FAROSI		10050	\$110000.0000	APPOINTED	YES	08/21/16	816
MORALES GIL	BASTI	A	51195	\$19.2800	APPOINTED	YES	08/21/16	816
MURPHY JR	ROBERT	J	21538	\$68469.0000	APPOINTED	YES	08/28/16	816
NAT	PRAHDEE	K	51022	\$31.5500	RESIGNED	YES	08/21/16	816
NIGEN	ESTHER	R	51022	\$31.5500	RESIGNED	NO	08/28/16	816
OKOROJI	JESSICA		51195	\$19.2800	APPOINTED	YES	08/21/16	816
OTERO	ERICA	L	70810	\$36652.0000	APPOINTED	NO	08/21/16	816
PAULINO	LISSETTE		56056	\$37396.0000	APPOINTED	YES	08/21/16	816
PETERSON	EBONY		81815	\$15.8300	APPOINTED	YES	08/21/16	816
PIERRE	DANILOVA		51195	\$23.2300	RESIGNED	NO	08/28/16	816
PIZARRO JR	CARLOS		06316	\$60759.0000	INCREASE	YES	08/21/16	816
PNDURWILLOW	PAANJHAL		81815	\$15.8300	APPOINTED	YES	08/21/16	816
PONDE	KIMONE		10095	\$88000.0000	INCREASE	YES	08/28/16	816

DEPT OF HEALTH/MENTAL HYGIENE
FOR PERIOD ENDING 09/09/16

NAME		TITLE	NUM	SALARY	ACTION	PROV	EFF DATE	AGENCY
PONDE	KIMONE		10124	\$62919.0000	APPOINTED	NO	08/28/16	816
PRIMO	CANDACEY	V	51195	\$19.2800	APPOINTED	YES	08/21/16	816
RAHMAN	ABUNOMAN	M	10124	\$44210.0000	RESIGNED	YES	10/22/08	816
RASCH	KIMBERLY	A	21744	\$87791.0000	INCREASE	NO	08/21/16	816
RENE	YVES		1002F	\$87393.0000	INCREASE	YES	08/07/16	816
ROBINSON	CHANTELLE	A	56056	\$31169.0000	APPOINTED	YES	08/21/16	816
ROMNEY-THOMAS	ZENETA	J	21538	\$60000.0000	INCREASE	YES	08/07/16	816
ROMNEY-THOMAS	ZENETA	J	31215	\$56347.0000	APPOINTED	NO	08/07/16	816
ROZZA	NICOLA		10					

YANKOVICH	SOFIYA	51193	\$56291.0000	RETIRED	NO	08/28/16	816
YARRELL	CHRISTOP	56058	\$65000.0000	RESIGNED	YES	08/21/16	816
YUSUFF	SULAIMON B	21514	\$57969.0000	RESIGNED	NO	08/17/16	816
ZEIGENFUSE	ANGELA D	21538	\$60000.0000	APPOINTED	YES	08/28/16	816
ZUCKOFF	ISABEL M	21744	\$57969.0000	APPOINTED	YES	08/21/16	816

ADMIN TRIALS AND HEARINGS
FOR PERIOD ENDING 09/09/16

NAME		TITLE	NUM	SALARY	ACTION	PROV	EFF DATE	AGENCY
BALSAM	HELAINA B	95005	\$140000.0000	RESIGNED	YES	08/28/16	820	
MIFTARI	LISJETA	10209	\$10.3500	RESIGNED	YES	08/28/16	820	
NAIR	SETHU L	56058	\$70000.0000	APPOINTED	YES	08/21/16	820	
ROMAN	NADINE C	52406	\$14.5900	RESIGNED	YES	08/28/16	820	

DEPT OF ENVIRONMENT PROTECTION
FOR PERIOD ENDING 09/09/16

NAME		TITLE	NUM	SALARY	ACTION	PROV	EFF DATE	AGENCY
ABASS	SHARAE L	56056	\$38131.0000	APPOINTED	YES	08/21/16	826	
AHMED	SALEK	20202	\$52000.0000	RESIGNED	YES	08/25/16	826	
ALLISON	MICHAEL R	91011	\$54243.0000	APPOINTED	NO	07/31/16	826	
AMARO	JANET	22122	\$84997.0000	RESIGNED	YES	08/21/16	826	
BARR	DWAYNE R	90748	\$28523.0000	APPOINTED	YES	08/22/16	826	
BOLT	MELODY J	31305	\$49255.0000	RESIGNED	YES	08/21/16	826	
CAMBRANES	GEORGE	20310	\$61665.0000	RETIRED	NO	08/30/16	826	
CAMPANELLA	ANTHONY	13632	\$74066.0000	APPOINTED	YES	08/21/16	826	
CHAN	PHILIP	20616	\$52000.0000	APPOINTED	YES	08/21/16	826	
CHEN	JACKY	31305	\$42830.0000	APPOINTED	YES	08/21/16	826	
COOPER	KODY A	20202	\$52000.0000	RESIGNED	YES	08/31/16	826	
CRAWFORD	CHRISAI	21822	\$47831.0000	RESIGNED	YES	08/26/16	826	
DAVIDOCK	THOMAS J	22122	\$76000.0000	APPOINTED	YES	08/21/16	826	
DICK	RONALD J	91645	\$363.9200	RETIRED	NO	08/21/16	826	
DOLAN BOCCADIFU	JANICE K	13621	\$83000.0000	APPOINTED	YES	08/21/16	826	
DOUGLAS	CHERELLE	10251	\$18.0011	APPOINTED	YES	08/21/16	826	
DUNCAN	TROY L	90748	\$28523.0000	APPOINTED	YES	08/21/16	826	
EDMOND	SANDRA R	10124	\$55144.0000	APPOINTED	NO	08/21/16	826	
ERMONGON	LOIZOS	34615	\$47778.0000	RESIGNED	NO	08/19/16	826	
FANOURAKIS	STAVROS	31305	\$42830.0000	APPOINTED	YES	08/21/16	826	
FERRANTE	JOSEPH A	90739	\$318.0800	RETIRED	NO	08/31/16	826	
GALLAGHER	MARK	90767	\$350.4800	RETIRED	NO	09/01/16	826	
GALLEGOS	CHRISTOP	22427	\$70422.0000	RESIGNED	YES	08/23/16	826	
GARRETT	VINCENT L	34620	\$76761.0000	INCREASE	NO	08/21/16	826	
GIBSON	ALEXANDR M	56058	\$73172.0000	INCREASE	YES	08/28/16	826	
GOZZA	CHRISTOP J	1002D	\$112291.0000	INCREASE	YES	08/21/16	826	
GRATE	TIERNY Y	10124	\$49284.0000	APPOINTED	NO	08/22/16	826	
GREENSTEIN	ELIZABET D	83008	\$120000.0000	APPOINTED	YES	08/21/16	826	
HAMID-SHAPIRO	LAUREN R	22122	\$75000.0000	INCREASE	YES	08/21/16	826	
HANNA	EMILE M	20215	\$84415.0000	RETIRED	NO	08/30/16	826	
HOLLEY	NEAL A	34620	\$76761.0000	INCREASE	YES	08/21/16	826	
HOSSAIN	BILLAL	20415	\$83726.0000	APPOINTED	YES	08/21/16	826	
HOSSAIN	BILLAL	20410	\$70265.0000	APPOINTED	YES	08/21/16	826	
INGLOT	MAREK T	90748	\$28522.0800	APPOINTED	YES	08/21/16	826	
INNELLA	MARIO C	90748	\$28522.0800	APPOINTED	YES	08/21/16	826	
IRIZARRY	EDDIE L	90739	\$318.0800	RESIGNED	NO	08/26/16	826	
JESSUP	MATTHEW	20618	\$93660.0000	INCREASE	YES	08/07/16	826	

DEPT OF ENVIRONMENT PROTECTION
FOR PERIOD ENDING 09/09/16

NAME		TITLE	NUM	SALARY	ACTION	PROV	EFF DATE	AGENCY
KENNY	BENJAMIN J	90748	\$28523.0000	APPOINTED	YES	08/21/16	826	
KHONDOKER	JULKERNI M	31220	\$60673.0000	APPOINTED	YES	08/22/16	826	
KLOSKOWSKI	MAGDALEN	13631	\$69217.0000	RESIGNED	YES	08/31/16	826	
KOCINSKY	JOHN E	90739	\$318.0800	DECEASED	NO	08/08/16	826	
KWARI	HASSANA	20113	\$50938.0000	RESIGNED	NO	08/21/16	826	
LACHMENAR	SUBRAMON J	34615	\$30565.0000	RESIGNED	YES	08/02/16	826	
LAFOREST	MICHEL	10251	\$20.7200	RETIRED	NO	08/25/16	826	
LAWANI	LUCKY O	20403	\$52000.0000	APPOINTED	YES	08/21/16	826	
LETOICH	JAMES	92510	\$287.6000	RETIRED	YES	09/01/16	826	
LETOICH	JAMES	92511	\$292.0800	RETIRED	NO	09/01/16	826	
MALK	MUBASHAR N	20616	\$52000.0000	APPOINTED	YES	08/21/16	826	
MANCELL	BENJAMIN A	13631	\$74754.0000	RESIGNED	YES	08/21/16	826	
MCGINTY	MICHAEL A	91645	\$363.9200	RETIRED	YES	09/02/16	826	
MELODIA	FRANCINE	12626	\$56693.0000	RETIRED	NO	08/25/16	826	
MINTERN	THOMAS	91011	\$54282.0000	RETIRED	NO	09/02/16	826	
MOHAMED	ALLEN J	90748	\$28523.0000	APPOINTED	YES	08/22/16	826	
MONTGOMERY	RANDY L	80609	\$30991.0000	TERMINATED	NO	08/17/16	826	
MOREY	ERIN K	21744	\$68239.0000	INCREASE	YES	08/28/16	826	
MOREY	ERIN K	12627	\$63817.0000	APPOINTED	NO	08/28/16	826	
NARASUWAN	ROSITA	56057	\$49570.0000	RETIRED	YES	08/30/16	826	
NARASUWAN	ROSITA	10251	\$38801.0000	RETIRED	NO	08/30/16	826	
NIDHAN	ANDRE H	12626	\$63343.0000	RESIGNED	NO	07/24/16	826	
OWENS	J'VON	13611	\$64017.0000	INCREASE	YES	08/21/16	826	
PATEL	CHAMPAKE R	91645	\$363.9200	RETIRED	NO	08/29/16	826	
PATTEN	GREGORY K	22121	\$48312.0000	RESIGNED	YES	08/21/16	826	
PAYNE	ANDREW R	21538	\$55015.0000	RESIGNED	YES	08/07/16	826	
PEDUTO	LOUIS M	90748	\$28523.0000	APPOINTED	YES	08/22/16	826	
PHILLIPS	SEAN M	90739	\$318.1100	RESIGNED	NO	08/28/16	826	
PIRELA	JO-ANN	10251	\$19.8000	INCREASE	NO	08/21/16	826	
POWELL	ANTON	90748	\$28523.0000	APPOINTED	YES	08/21/16	826	
PUGLIA	PAUL	34620	\$76761.0000	INCREASE	YES	08/21/16	826	
SHEHATA	ADEL E	34615	\$47778.0000	DISMISSED	NO	08/16/16	826	
SOMMA	PATRICK A	70811	\$41922.0000	TERMINATED	NO	08/26/16	826	
STEPHENSON	ANN C	12158	\$60851.0000	INCREASE	YES	08/21/16	826	
STERN	MATTHEW A	90748	\$28523.0000	APPOINTED	YES	08/22/16	826	
THAISZ	DAVID	90739	\$318.0800	RETIRED	NO	09/01/16	826	
VAN NOY	MARY	30087	\$82748.0000	RESIGNED	YES	08/21/16	826	
VANEPSS	JAMEY J	83008	\$80000.0000	APPOINTED	YES	08/21/16	826	
VARGAS	JULISSA	40502	\$67409.0000	INCREASE	NO	08/21/16	826	
VASQUEZ	ERNESTO	90748	\$28523.0000	APPOINTED	YES	08/21/16	826	
WALLACE	STEVEN	34620	\$76761.0000	RETIRED	NO	08/25/16	826	

WILLIAMS	KEITH J	10124	\$70557.0000	RETIRED	NO	08/31/16	826
WOOD	MATTHEW E	70811	\$68886.0000	RETIRED	NO	08/31/16	826
YULFO	CARMELO	90739	\$318.0800	RESIGNED	NO	08/26/16	826

DEPARTMENT OF SANITATION
FOR PERIOD ENDING 09/09/16

NAME		TITLE	NUM	SALARY	ACTION	PROV	EFF DATE	AGENCY
AGOSTINO JR	ANTHONY A	70112	\$35643.0000	APPOINTED	NO	08/21/16	827	
ARLEQUIN	CARLOS I	70112	\$35643.0000	APPOINTED	NO	08/21/16	827	
AYANRU	IYORE	70112	\$35643.0000	APPOINTED	NO	08/21/16	827	
BAIG	WAJID M	92575	\$102263.0000	PROMOTED	NO	08/29/16	827	
BARBACCIA	DANIEL J	70112	\$35643.0000	APPOINTED	NO	08/21/16	827	
BATTAGLIA	ANDREW S	70112	\$35643.0000	APPOINTED	NO	08/21/16	827	
BAUER	FRANZ J	70112	\$35643.0000	APPOINTED	NO	08/21/16	827	
BIANCO	ADAM A	70112	\$35643.0000	APPOINTED	NO	08/21/16	827	
BIANROSA	ROBERT M	70112	\$35643.0000	APPOINTED	NO	08/21/16	827	
BILOTTO	VINCENT M	70112	\$35643.0000	APPOINTED	NO	08/21/16	827	
BINDER	JOSEPH B	70112	\$35643.0000	APPOINTED	NO	08/21/16	827	
BLASZCZYK	TOMASZ	70112	\$35643.0000	APPOINTED	NO	08/21/16	827	
BRANCH	EVERETT M	70112	\$73235.0000	RETIRED	NO	09/01/16	827	
CALCATTERRA	MICHAEL S	70112	\$35643.0000	APPOINTED	NO	08/21/16	827	
CAMPOLI	ANTHONY	70112	\$35643.0000	APPOINTED	NO	08/21/16	827	
CAPUTO	ANTHONY S	70112	\$35643.0000	APPOINTED	NO	08/21/16	827	
CARANNANTE	GERALD	7019B	\$166808.0000	RETIRED	NO	08/31/16	827	
CARMONA	JASMINE A	10209	\$11.3000	RESIGNED	YES	08/21/16	827	
CARUSO	MARY ANN	10251	\$37854.0000	RETIRED	YES	09/02/16	827	
CASTALDO	PHILIP S	70112	\$38664.0000	RESIGNED	NO	08/09/16	827	
CHALUISANT	ANDREW W	70112	\$35643.0000	APPOINTED	NO	08/21/16	827	
CHEN	ALBERT	10234	\$12.3900	RESIGNED	YES	08/21/16	827	
CHEN	RICHARD	70112	\$35643.0000	APPOINTED	NO	08/21/16	827	
CIMONETTI	RICHARD J	70112	\$73235.0000	RETIRED	NO	09/02/16	827	
CIRAULO	STEVEN M	70112	\$35643.0000	APPOINTED	NO	08/21/16	827	
CLANTON	ELLIOT J	70112	\$38664.0000	RESIGNED	NO	08/21/16	827	
COLLAZO	CHRISTIA	70112	\$35643.0000	APPOINTED	NO	08/21/16	827	
COOPER	NICOLE A	70112	\$35643.0000	APPOINTED	NO	08/21/16	827	
CORDOVA	CHRISTIA M	70112	\$35643.0000	APPOINTED	NO	08/21/16	827	
COREAS	LUIS A	92510	\$268.9600	APPOINTED	YES	08/21/16	827	
CORREA	REINALDO C	70112	\$35643.0000	APPOINTED	NO	08/21/16	827	
CUCCHIARA	GIUSEPPE	70112	\$35643.0000	APPOINTED	NO	08/21/16	827	
D'ADAMO	STEPHANI	70112	\$35643.0000	APPOINTED	NO	08/21/16	827	
D'ORAZIO	LUKE J	10124	\$49284.0000	APPOINTED	YES	08/18/16	827	
DALEY	LISA C	56057	\$54549.0000	INCREASE	YES	08/21/16	827	
DALEY	LISA C	10251	\$44549.0000	APPOINTED	NO	08/21/16	827	
DAVIS	KENNETH D	70112	\$73235.0000	RETIRED	NO	09/01/16	827	
DAY	RONALD	70112	\$73235.0000	RETIRED	NO	08/31/16	827	
DECAPITE	MICHAEL G	70112	\$35643.0000	APPOINTED	NO	08/21/16	827	
DECHIRICO	FREDERIC N	70112	\$35643.0000	APPOINTED	NO	08/21/16	827	
DELUCA	ELIZABET	70112	\$35643.0000	APPOINTED	NO	08/21/16	827	
DENT	CONNOR T	70112	\$73235.0000	RETIRED	NO	09/01/16	827	
DI MARCO	CHARLES	70112	\$73235.0000	RETIRED	NO	09/02/16	827	
DIAZ	LUIS R	70112	\$35643.0000	APPOINTED	NO	08/21/16	827	
DIBENEDETTO III	VINCENT	70112	\$35643.0000	APPOINTED	NO	08/21/16	827	
DIGIOIA	ANTHONY V	70112	\$35643.0000	APPOINTED	NO	08/21/16	827	
DRON	KREYSZTO	70112	\$35643.0000	APPOINTED	NO	08/21/16	827	
DUNN	CHRISTOP J	70112	\$35643.0000	APPOINTED	NO	08/21/16	827	
ESPOSITO	WAYNE P	92575	\$102263.0000	PROMOTED	NO	08/29/16	827	
FAAM	SOBHY	12158	\$36499.0000	APPOINTED	NO	08/28/16	827	
FAELLO	JOSEPH	70112	\$35643.0000	APPOINTED	NO	08/21/16	827	

DEPARTMENT OF SANITATION
FOR PERIOD ENDING 09/09/16

NAME		TITLE	NUM	SALARY	ACTION	PROV	EFF DATE	AGENCY
FIER								

KOVARIK	ANDREW	K	70112	\$35643.0000	INCREASE	NO	08/21/16	827
KOVARIK	ANDREW	K	71681	\$33400.0000	APPOINTED	NO	08/21/16	827
LA SCALA	SALVATOR		70112	\$35643.0000	APPOINTED	NO	08/21/16	827
LAM	WEI MAN		70112	\$35643.0000	APPOINTED	NO	08/23/16	827
LASKER	RAM		70112	\$35643.0000	APPOINTED	NO	08/21/16	827
LAWAL	BABAJIDE	I	56058	\$48895.0000	APPOINTED	YES	08/28/16	827
LEHE	BRIAN	P	70112	\$35643.0000	APPOINTED	NO	08/21/16	827
LEIBOWITZ	STEVEN		70112	\$73235.0000	RETIRED	NO	09/01/16	827
LOGIUDICE	JOSEPH		70112	\$35643.0000	APPOINTED	NO	08/21/16	827
LOUTAN	SAMLALL		92575	\$102263.0000	PROMOTED	NO	08/28/16	827
LOWDER	JASON	J	70112	\$35643.0000	APPOINTED	NO	08/21/16	827
LYONS	DARRELL	E	70112	\$73235.0000	RETIRED	NO	09/01/16	827
MAGNONE	DOMENICK		70112	\$73235.0000	RETIRED	NO	09/02/16	827

DEPARTMENT OF SANITATION
FOR PERIOD ENDING 09/09/16

TITLE								
NAME			NUM	SALARY	ACTION	PROV	EFF DATE	AGENCY
MALONE	BRIDGET	M	70112	\$35643.0000	APPOINTED	NO	08/21/16	827
MANGUAL	JEFFREY	J	70112	\$35643.0000	APPOINTED	NO	08/21/16	827
MANNION	MICHAEL	L	70112	\$73235.0000	RETIRED	NO	09/02/16	827
MARRERO	EDDIE		70112	\$35643.0000	APPOINTED	NO	08/21/16	827
MARSHALL	KEVIN	J	80633	\$11.7900	RESIGNED	YES	08/07/16	827
MASSO	PATRICK	D	70112	\$35643.0000	APPOINTED	NO	08/21/16	827
MAURI	MANUEL		70112	\$73235.0000	RETIRED	NO	09/02/16	827
MCCOLGAN	JOHN	A	70112	\$35643.0000	APPOINTED	NO	08/21/16	827
MCGOWAN JR	WILLIAM	S	70112	\$35643.0000	APPOINTED	NO	08/21/16	827
MCNEAL	LESTER		70112	\$73235.0000	RETIRED	NO	09/02/16	827
MEGHER	SEAN	T	70112	\$35643.0000	APPOINTED	NO	08/21/16	827
MERCADO	ERIC	J	70112	\$35643.0000	APPOINTED	NO	08/21/16	827
MISIR	CHAITRAM	R	70112	\$35643.0000	APPOINTED	NO	08/21/16	827
MOHAMED	EMAD		70112	\$35643.0000	APPOINTED	NO	08/21/16	827
MOORE	THOMAS	M	70112	\$35643.0000	APPOINTED	NO	08/21/16	827
MORALES	ERIC	C	70112	\$35643.0000	APPOINTED	NO	08/21/16	827
MULQUEEN	DANIEL	R	70112	\$35643.0000	APPOINTED	NO	08/21/16	827
MURGOLO	WILLIAM	N	70112	\$73235.0000	RETIRED	NO	09/02/16	827
MUTHU	GREGORY	M	70112	\$35643.0000	APPOINTED	NO	08/21/16	827
NASIR	ESHITA		10234	\$12.3900	RESIGNED	YES	08/21/16	827
NAVAS	JORGE	B	70112	\$35643.0000	APPOINTED	NO	08/21/16	827
NEPOLA	ADAM		70112	\$35643.0000	APPOINTED	NO	08/21/16	827
NICOLOSI	ALFREDO		70112	\$35643.0000	APPOINTED	NO	08/21/16	827
O'TOOLE	BRIAN	J	70112	\$35643.0000	APPOINTED	NO	08/21/16	827
OBERIKA	CHINYELU	C	10232	\$20.5900	RESIGNED	YES	08/21/16	827
OLAVARRIA	REBECCA	M	10209	\$10.3500	RESIGNED	YES	08/24/16	827
OLIVO	CLINT	A	70112	\$35643.0000	APPOINTED	NO	08/21/16	827
ORDONEZ	KENNETH	R	70112	\$35643.0000	APPOINTED	NO	08/21/16	827
ORTIZ	EDWINRAY		70112	\$35643.0000	APPOINTED	NO	08/21/16	827
PALLADINO	SANTO	M	70112	\$73235.0000	RETIRED	NO	08/31/16	827
PAPALLO	PATRICK		70112	\$35643.0000	APPOINTED	NO	08/21/16	827
PATTEN	GREGORY	K	56058	\$56229.0000	APPOINTED	YES	08/21/16	827
PENA-MOLINA	ROBERTO		70112	\$35643.0000	APPOINTED	NO	08/21/16	827
PERAZIC	AFRIM		70112	\$35643.0000	APPOINTED	NO	08/21/16	827
PERSAUD	TISHAUN		92510	\$268.9600	APPOINTED	YES	08/21/16	827
PICCA	GIUSEPPE		70112	\$35643.0000	APPOINTED	NO	08/21/16	827
POLLACK	YAAKOV		70112	\$35643.0000	APPOINTED	NO	08/21/16	827
PORCELLA	DANIEL		70112	\$35643.0000	APPOINTED	NO	08/21/16	827
PUGLIESE	CHRISTOP	D	70112	\$35643.0000	APPOINTED	NO	08/21/16	827
PYRYC	JAKUB	K	70112	\$35643.0000	APPOINTED	NO	08/21/16	827
RACHAKONDA	VENKATES		13643	\$127000.0000	APPOINTED	YES	08/28/16	827
RAMIREZ	CHRISTIN	N	10209	\$11.3000	RESIGNED	YES	08/26/16	827
RATHOD	SAGAR	G	70112	\$35643.0000	APPOINTED	NO	08/21/16	827
RELLA	JAMES	A	70112	\$35643.0000	APPOINTED	NO	08/21/16	827
RIOS JR.	JOSE	A	70112	\$73235.0000	RETIRED	NO	09/01/16	827
RIZZO	MICHAEL	A	70112	\$35643.0000	APPOINTED	NO	08/21/16	827
ROBERTSON JR.	JAMES	H	70112	\$35643.0000	APPOINTED	NO	08/21/16	827
RODRIGUEZ	STEVEN	A	70112	\$35643.0000	APPOINTED	NO	08/21/16	827
ROMAN	JESUS		70112	\$35643.0000	APPOINTED	NO	08/21/16	827
ROMERO	CARLOS	G	70112	\$73235.0000	RETIRED	NO	08/28/16	827
RUSSO	JOSEPH	P	70112	\$35643.0000	APPOINTED	NO	08/21/16	827

DEPARTMENT OF SANITATION
FOR PERIOD ENDING 09/09/16

TITLE								
NAME			NUM	SALARY	ACTION	PROV	EFF DATE	AGENCY
SAFI	KAMALODE		70112	\$35643.0000	APPOINTED	NO	08/21/16	827
SARNO	JOHN	M	70112	\$35643.0000	APPOINTED	NO	08/21/16	827
SCHININA	CORRADO		70112	\$35643.0000	APPOINTED	NO	08/21/16	827
SCHUFF	KARL	F	70112	\$35643.0000	APPOINTED	NO	08/21/16	827
SIGILLO	ANTONIO	F	70112	\$35643.0000	APPOINTED	NO	08/21/16	827
SIRETZ	JONATHAN		70112	\$35643.0000	APPOINTED	NO	08/21/16	827
SMITH JR	GODFREY	G	70112	\$35643.0000	APPOINTED	NO	08/21/16	827
STEPHENS	JAMES	D	91404	\$13.5000	APPOINTED	YES	01/24/16	827
TANZI	ALBERT		70112	\$73235.0000	RETIRED	NO	09/02/16	827
TETA	NICHOLAS	A	92510	\$313.0400	RETIRED	NO	09/02/16	827
TOLBERT	SHAUNTAE		70112	\$35643.0000	APPOINTED	NO	08/21/16	827
TORRES	GEORGE	A	70112	\$35643.0000	APPOINTED	NO	08/21/16	827
TORRES III	RAUL		70112	\$35643.0000	APPOINTED	NO	08/21/16	827
TSINTAVIS	CHRIS		70112	\$35643.0000	APPOINTED	NO	08/21/16	827
TUOZZO JR	MARTIN	J	70112	\$35643.0000	APPOINTED	NO	08/21/16	827
VARRONE	PAUL		92510	\$313.0400	RESIGNED	NO	08/23/16	827
VASQUEZ	ALEJANDR	C	70112	\$35643.0000	APPOINTED	NO	08/21/16	827
VELLON JR	JULIO		70112	\$35643.0000	APPOINTED	NO	08/21/16	827
VOUZAKIS	ARISTIDI		70112	\$35643.0000	APPOINTED	NO	08/21/16	827
WANG	KEVIN		70112	\$35643.0000	APPOINTED	NO	08/21/16	827
WATSON	EUGENE	C	70112	\$35643.0000	APPOINTED	NO	08/21/16	827
WIHLBOG	DOUGLAS	J	70112	\$35643.0000	APPOINTED	NO	08/21/16	827
YAM	MICHAEL		70112	\$35643.0000	APPOINTED	NO	08/21/16	827
YONG	LARRY		92575	\$102263.0000	PROMOTED	NO	08/29/16	827
ZAMMIT	SPENCER	L	70112	\$35643.0000	APPOINTED	NO	08/21/16	827
ZAPPOLA	MICHAEL	P	70112	\$35643.0000	APPOINTED	NO	08/21/16	827

DEPARTMENT OF FINANCE
FOR PERIOD ENDING 09/09/16

TITLE								
NAME			NUM	SALARY	ACTION	PROV	EFF DATE	AGENCY
AGGARWAL	SHAUN	A	10234	\$9.0000	RESIGNED	YES	08/25/16	836
AMANDOLARE	JOHN	M	30087	\$71753.0000	RESIGNED	YES	08/28/16	836
BROOKS	MILTON	R	30312	\$80788.0000	RETIRED	NO	08/25/16	836
DE ALMEIDA BARR	MARCELO		10232	\$13.5237	RESIGNED	YES	07/31/16	836
DEPIETRO	MICHELLE	A	10209	\$9.7500	RESIGNED	YES	08/26/16	836
DISTEFANO	LISA		10124	\$55144.0000	APPOINTED	NO	08/28/16	836
DMITRIEVA	ELENA		13631	\$69215.0000	APPOINTED	YES	08/21/16	836
DOUGLAS	JAMES	F	40523	\$45000.0000	APPOINTED	YES	08/21/16	836
ENG	ANTHONY		10124	\$49284.0000	APPOINTED	NO	08/28/16	836
ENG	PHILIP		40202	\$81826.0000	INCREASE	YES	08/28/16	836
FLETCHER	DAWN	V	40202	\$51750.0000	INCREASE	YES	08/28/16	836
GAPFAR	ALEA	L	10251	\$34143.0000	RESIGNED	NO	08/25/16	836
GENTILE	JAYMEE		10234	\$9.0000	RESIGNED	YES	08/21/16	836
GORDON	ANN MARI		12158	\$72608.0000	DISMISSED	NO	08/24/16	836
HATCHER	SHRON		10124	\$61004.0000	INCREASE	NO	08/28/16	836

DEPARTMENT OF FINANCE
FOR PERIOD ENDING 09/09/16

TITLE								
NAME			NUM	SALARY	ACTION	PROV	EFF DATE	AGENCY
HERNANDEZ	KRISTIE	T	10124	\$42856.0000	APPOINTED	NO	08/28/16	836
HERNANDEZ	WILLIAM		40523	\$68866.0000	INCREASE	NO	08/21/16	836
JACKSON	CURTIS	T	10124	\$49284.0000	APPOINTED	NO	08/28/16	836
JAMES	TIFFANY	N	10124	\$66000.0000	APPOINTED	YES	08/28/16	836
JAN	YENCHEN		40523	\$79300.0000	RETIRED	NO	08/20/16	836
KIREJUCZYK	CHRISTOP		40202	\$78991.0000	INCREASE	YES	08/28/16	836
LIEBER	SANFORD	S	40523	\$71052.0000	RETIRED	NO	09/02/16	836
LOCKE	KENITRA	M	10224	\$48366.0000	APPOINTED	YES	08/28/16	836
LULAJ	ESADA		40202	\$59512.0000	INCREASE	YES	08/28/16	836
MEMPOINT JR	JEAN	C	40202	\$78991.0000	INCREASE	YES	08/28/16	836
NADER III	GEORGES		10232	\$13.5237	RESIGNED	YES	08/21/16	836
PARKER	DEMARCUS	N	40202	\$51750.0000	INCREASE	YES	08/28/16	836
PURI	RAKSHAT		10232	\$13.5237	RESIGNED	YES	08/25/16	836
ROZZA	NICOLA		1002E	\$95113.0000	RESIGNED	YES	08/21/16	836
SIEGAL	JAMES	M	40523	\$82375.0000	APPOINTED	NO	08/28/16	836
SKUZEMSKI	DEREK	A	30315	\$93552.0000	PROMOTED	NO	08/28/16	836
SUZEL, JR.	FREDERIC	A	40202	\$78991.0000	INCREASE	YES	08/28/16	836
TONG	KA YOUNG		40202	\$81826.0000	INCREASE	NO	08/28/16	836
VAZQUEZ	LAURIE		10124	\$49284.0000	APPOINTED	NO	08/28/16	836
WILSON	VALARIE		10124	\$49613.0000	RETIRED	NO	08/26/16	836
ZHAO	ALEXANDE	Q	10234	\$9.0000	RESIGNED	YES	08/21/16	836
ZILBER	YEVGENIY		40202	\$51750.0000	INCREASE	YES	08/28/16	836

DEPARTMENT OF TRANSPORTATION
FOR PERIOD ENDING 09/09/16

TITLE								
NAME			NUM	SALARY	ACTION	PROV	EFF DATE	AGENCY
ABRAHAM	SUSAN		1007B	\$107613.0000	RETIRED	YES	08/24/16	841
ABRAHAM	SUSAN		34205	\$65698.0000	RETIRED	NO	08/24/16	841
ACEVEDO	SANTIAGO		91529	\$53374.0000	RETIRED	NO	09/02/16	841
ACQUISTA	JACK		91717	\$343.0000	PROMOTED	NO	08/29/16	841
AMIN	SYED	M	35007	\$29842.0000	APPOINTED	YES	08/28/16	841
BAESZLER	PATRICK	W	91529	\$46412.0000	APPOINTED	YES	08/28/16	841
BAPTISTE	THOMAS		92406	\$315.6800	RETIRED	NO	09/02/16	841
C								

DEPT OF PARKS & RECREATION
FOR PERIOD ENDING 09/09/16

Table with columns: NAME, TITLE, NUM, SALARY, ACTION, PROV EFF DATE, AGENCY. Lists employees like JEAN A 60421, OMEKA 80633, RICHARD J 60421, etc.

DEPT OF PARKS & RECREATION
FOR PERIOD ENDING 09/09/16

Table with columns: NAME, TITLE, NUM, SALARY, ACTION, PROV EFF DATE, AGENCY. Lists employees like JAMES 80633, ELIZABET K 06664, JEFFREY 81106, etc.

DEPT OF PARKS & RECREATION
FOR PERIOD ENDING 09/09/16

Table with columns: NAME, TITLE, NUM, SALARY, ACTION, PROV EFF DATE, AGENCY. Lists employees like JOVAN M 80633, SHANIQUA L 80633, NICKOLAO 60421, etc.

Table with columns: NAME, TITLE, NUM, SALARY, ACTION, PROV EFF DATE, AGENCY. Lists employees like JAIME 81106, NAILE 60421, LERIN L 56058, etc.

DEPT OF PARKS & RECREATION
FOR PERIOD ENDING 09/09/16

Table with columns: NAME, TITLE, NUM, SALARY, ACTION, PROV EFF DATE, AGENCY. Lists employees like DELIA 80633, JAN P 21315, JAN P 21310, etc.

DEPT. OF DESIGN & CONSTRUCTION
FOR PERIOD ENDING 09/09/16

Table with columns: NAME, TITLE, NUM, SALARY, ACTION, PROV EFF DATE, AGENCY. Lists employees like ELIAS 22425, KAZI MD 22427, ALVIN 20215, etc.

DEPT OF INFO TECH & TELECOMM
FOR PERIOD ENDING 09/09/16

Table with columns: NAME, TITLE, NUM, SALARY, ACTION, PROV EFF DATE, AGENCY. Lists employees like REINA M 10260, CHISOM 30087, SARWAR 10050, etc.

LEGEND

- E.L.P. EDGE OF RIGHT
- S.W.M. SIDEWALK
- BT. BENCHMARK
- ST. STEEL FACED CONCRETE CURB
- DC. DRIVE CURB
- C.L.F. CURB LINE
- 23. INDICATES TAX LOT NUMBER
- BLOCK 7074 INDICATES TAX BLOCK NUMBER
- INDICATES STREET RIGHT OF WAY LINE
- INDICATES TAX LOT LINE
- INDICATES DIMENSION LINE
- INDICATES PROPOSED RIGHT OF WAY LINE
- INDICATES ACQUISITION LINE
- 509.46' INDICATES TAX MAP DIMENSION
- 113.7' INDICATES DIMANCE PARCEL NUMBER

NOTES

1. UNDERGROUND UTILITIES AND SUBSTRUCTURES ARE NOT SHOWN.
2. EXISTING SURVEY SHOWN TAKEN FROM FIELD MEASUREMENTS PERFORMED AT THE SITE DATED JUNE 2015.
3. ALL DIMENSIONS AND SIZES ARE SHOWN IN U.S. FEET.

REFERENCES

1. BROOKLYN FINAL SECTION MAP 118
2. BROOKLYN TAX MAPS
3. BROOKLYN TOPOGRAPHIC BUREAU MAP NO. Y-2715, SHOWING THE BOUNDARIES OF THE CITY AND STREETS OF NEW YORK, WEST 10TH ST. THROUGH WEST 12TH ST. AND WEST 12TH ST. AND ESTABLISHING WEST WALK, COPYRIGHT 2009



Damage and Acquisition Map Stage 1

IN THE MATTER OF THE APPLICATION OF THE CITY OF NEW YORK RESOLVE TO ACQUIRE TITLE TO BLOCK 7074, PART OF LOTS 4, 23 AND 105

REQUIRED TO ESTABLISH NEW STREETS AND PARCELS WITHIN THE CITY ISLAND PLAIN - STAGE 1

DATED: AUGUST 3, 2016
REV. SEPT. 21, 2016
SHEET NO. 2 OF 2

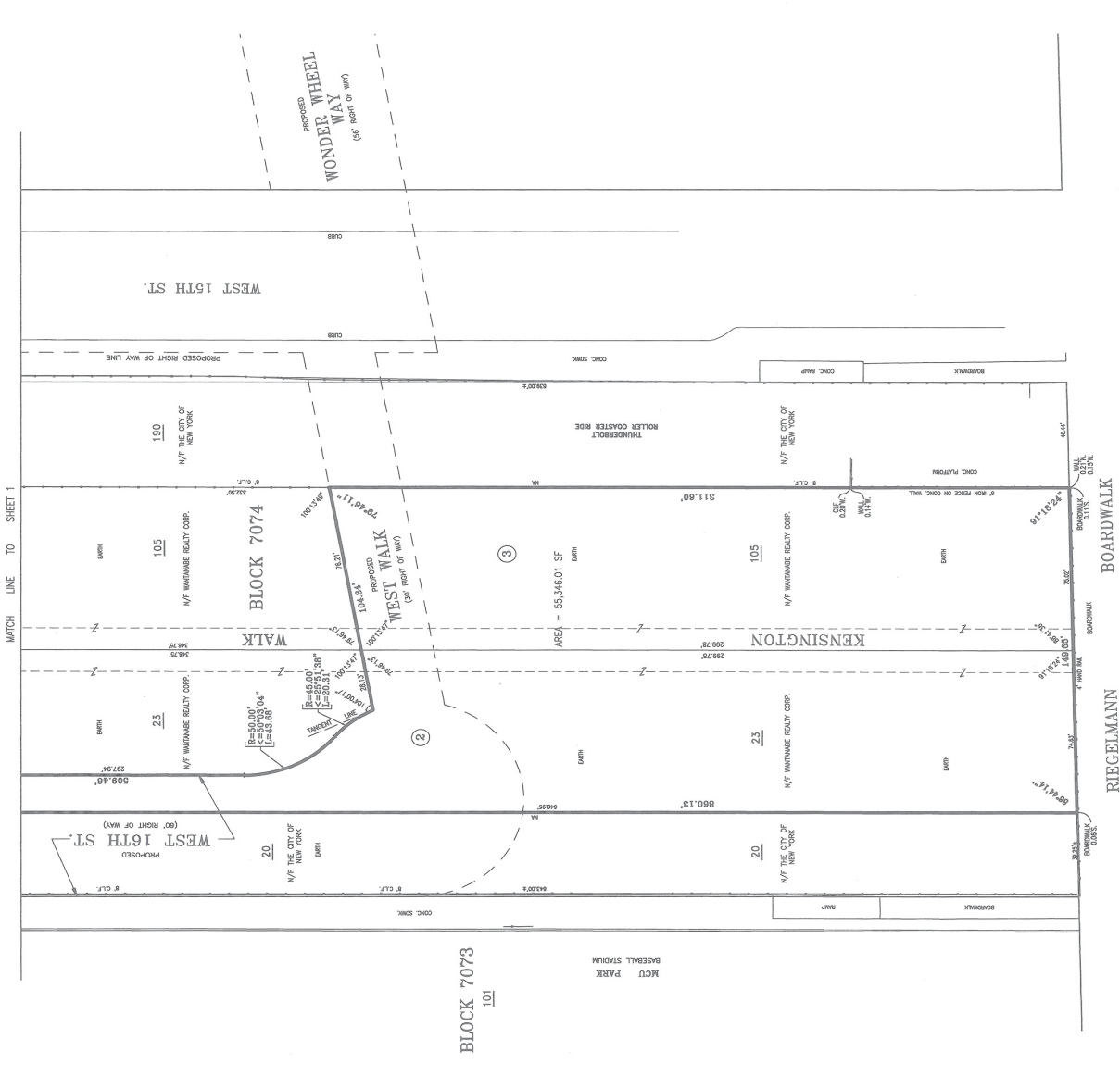

BLOCK	LOT	REMARKS	AREA IN SQ. FT.	ASSESSOR	VALUATION
1	105	WANTING REALTY CORP.	1,316,600	78,514	1,378,600
2	23	WANTING REALTY CORP.	229,878	83,700	250,000
3	20	WANTING REALTY CORP.	55,246.01	1,000,000	1,000,000

PREPARED BY: **HAKS ENGINEERS, ARCHITECTS & LAND SURVEYORS P.C.**
 100 WEST 10TH STREET, SUITE 1000
 NEW YORK, NY 10005

DATE: 9/21/16

ACRES: 0.00081-1

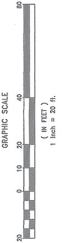

MAP NO. 4231
SHEET 2 OF 2

REFERENCE MAPS
V562-7647

FINAL MAPS:

WORKING SHEETS:
T1200-4
T200-6



PARCEL NO.	AREA IN SQ. FT.	OWNER	ADDRESS	DATE	REMARKS
1	1,234
2	1,567
3	1,890
4	2,123
5	2,456
6	2,789
7	3,123
8	3,456
9	3,789
10	4,123
11	4,456
12	4,789
13	5,123
14	5,456
15	5,789
16	6,123
17	6,456
18	6,789
19	7,123
20	7,456
21	7,789
22	8,123
23	8,456
24	8,789
25	9,123
26	9,456
27	9,789
28	10,123
29	10,456
30	10,789

Handwritten notes:
10/14/16
10/14/16

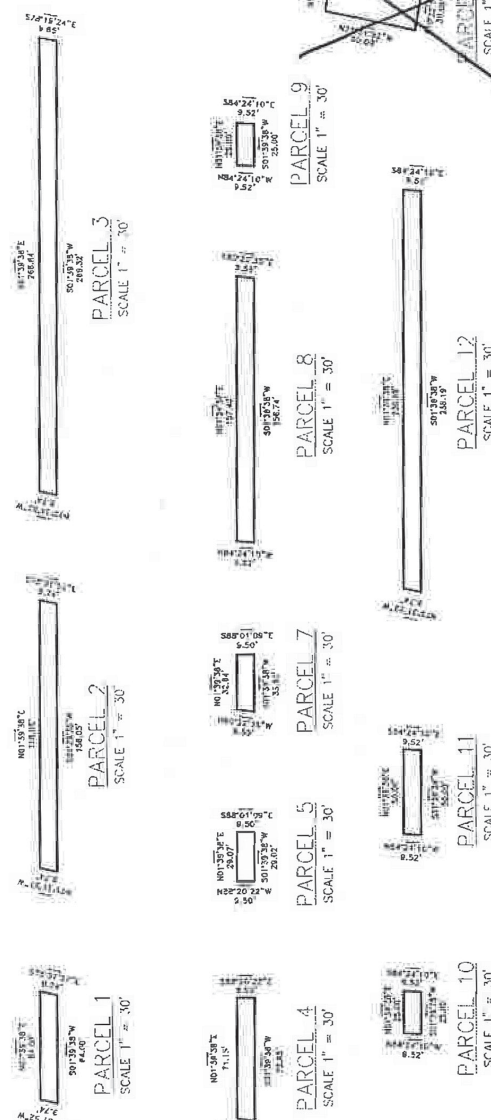

ALL BLOCKS AND LOTS HEREOF SHOWN ARE STATEN ISLAND PARCELS AS SHOWN ON THE TAX MAP OF THE CITY OF NEW YORK FOR THE BOROUGH OF STATEN ISLAND AS SAID TAX MAP EXISTED IN DECEMBER 2005

CITY OF NEW YORK BOROUGH OF STATEN ISLAND
TOPONYMIC BUREAU

DAMAGE & ACQUISITION MAP
NO. 4231

IN THE MATTER OF ACQUIRING TITLE IN FEE SIMPLE TO
ALL OR PARTS OF
SOUTH AVENUE
FROM NETHERLAND AVENUE TO FOREST AVENUE

IN THE BOROUGH OF STATEN ISLAND
CITY OF NEW YORK

PREPARED FOR:
CITY OF NEW YORK
DEPARTMENT OF DESIGN & CONSTRUCTION
DIVISION OF INFRASTRUCTURE

PREPARED BY:
AKRE ENGINEERING, P.C.
440 PARK AVENUE SOUTH
NEW YORK, N.Y. 10018

DWG. FILE:
11/15/16

DAMAGE & ACQUISITION MAP
NO. 4231

DATE: JULY 6, 2012
SHEET: 2 OF 2

ONLY COPIES FROM THE ORIGINAL OF THIS SURVEY MARKED WITH AN ORIGINAL OF THE LAND SURVEYOR'S INKED OR EMBOSSED SEAL SHALL BE CONSIDERED TO BE A TRUE VALID COPY

"UNAUTHORIZED ALTERATIONS OR ADDITION TO A LAND SURVEYING DRAWING BEARING A LICENSED PROFESSIONAL LAND SURVEYOR'S SEAL IS A VIOLATION OF ARTICLE 145, SECTION 7209 PARAGRAPH 2 OF THE NEW YORK STATE EDUCATION LAW"

ALL INFORMATION ON THIS MAP SUBJECT THAT PERTAINING TO THE PROPERTY LINE IS FOR REFERENCE ONLY. THE BOUNDARIES AND AREA ARE A SYSTEM ESTABLISHED BY THE UNITED STATES COAST AND GEODETIC SURVEY FOR THE (BOROUGH) OF STATEN ISLAND.

COMMISSIONER, DEPARTMENT OF TRANSPORTATION

Signature: James S. O'Leary
JAMES S. O'LEARY
PRESIDENT, BOROUGH OF STATEN ISLAND

COMMISSIONER, DEPARTMENT OF TRANSPORTATION

REVISIONS:

NO.	DATE	DESCRIPTION
1	10/14/16	...
2	10/14/16	...
3	10/14/16	...
4	10/14/16	...
5	10/14/16	...
6	10/14/16	...
7	10/14/16	...
8	10/14/16	...
9	10/14/16	...
10	10/14/16	...
11	10/14/16	...
12	10/14/16	...
13	10/14/16	...
14	10/14/16	...
15	10/14/16	...
16	10/14/16	...
17	10/14/16	...
18	10/14/16	...
19	10/14/16	...
20	10/14/16	...
21	10/14/16	...
22	10/14/16	...
23	10/14/16	...
24	10/14/16	...
25	10/14/16	...
26	10/14/16	...
27	10/14/16	...
28	10/14/16	...
29	10/14/16	...
30	10/14/16	...

ROBERT E. ERGELLEY, P.E., AIA
DIRECTOR OF LAND USE

Signature: Robert E. Ergelley

ROBERT E. ERGELLEY, P.E., AIA
DIRECTOR OF LAND USE

APPROVED BY:

APPROVED BY:

APPROVED BY:

APPROVED BY: