

## **THE COUNCIL**

---

*Minutes of the Proceedings for the*

### **STATED MEETING**

*of*

Wednesday, December 6, 2023, 3:20 p.m.

*The Majority Leader (Council Member Powers)  
presiding as the Acting President Pro Tempore*

#### Council Members

Adrienne E. Adams, *The Speaker*

Shaun Abreu	Jennifer Gutiérrez	Lincoln Restler
Joann Ariola	Shahana K. Hanif	Kristin Richardson Jordan
Alexa Avilés	Kamillah Hanks	Kevin C. Riley
Diana I. Ayala	Robert F. Holden	Carlina Rivera
Charles Barron	Crystal Hudson	Rafael Salamanca, Jr
Joseph C. Borelli	Rita C. Joseph	Pierina Ana Sanchez
Erik D. Bottcher	Ari Kagan	Lynn C. Schulman
Justin L. Brannan	Shekar Krishnan	Althea V. Stevens
Gale A. Brewer	Farah N. Louis	Sandra Ung
Selvena N. Brooks-Powers	Christopher Marte	Inna Vernikov
Tiffany Cabán	Julie Menin	Nantasha M. Williams
David M. Carr	Francisco P. Moya	Julie Won
Carmen N. De La Rosa	Mercedes Narcisse	Kalman Yeger
Eric Dinowitz	Sandy Nurse	
Amanda Farías	Chi A. Ossé	
Oswald Feliz	Vickie Paladino	
James F. Gennaro	Keith Powers	

Absent: Council Members Mealy and Velázquez;

Medical Leave: Council Member Lee.

The Majority Leader (Council Member Powers) assumed the chair as the Acting President Pro Tempore and Presiding Officer for these proceedings. Following the gaveling-in of the Meeting and the recitation of the Pledge of Allegiance, the Roll Call for Attendance was called by the City Clerk and the Clerk of the Council (Mr. McSweeney).

After consulting with the City Clerk and Clerk of the Council (Mr. McSweeney), the presence of a quorum was announced by the Majority Leader and the Acting President Pro Tempore (Council Member Powers).

*There were 48 Council Members marked present at this Stated Meeting held in the Council Chambers at City Hall, New York, N.Y. (including Council Member Moya who participated remotely).*

### INVOCATION

The Invocation was delivered by Rabbi Joel Mosbacher, Temple Shaaray Tefila, located at 250 East 79 Street, New York, N.Y. 10075.

Holy One of Blessing,  
we call you by many names.  
Jews call you the one  
who created all of us in your image.  
May you inspire this Council  
to carry out its deliberations  
and make its decisions  
with that oneness in mind.  
Ours is a city made up of many languages,  
races, ethnicities, genders, sexualities, and faiths.  
Ours is a city made up of people who were born here  
and of people who came here yesterday.  
Ours is a city made up of people  
who have everything they need and of people  
who have barely enough to survive.  
May this Council remember and act  
with the awareness that every one of us  
was created in the image of the divine.  
Oh God, you must have a huge heart  
because you have created us with huge hearts.  
Having just returned from Israel on a mission  
with our Reform Jewish Movement,  
I was reminded of just how big our hearts can be.  
We can have compassion for innocent Israelis  
and for innocent Palestinians at the same time.  
Our hearts are big,  
and we can have compassion  
for more than one thing,  
for more than one group of people at a time.  
As we approach Hanukkah, the Jewish Festival of Light,  
may this Council ensure that  
while the hearts of New Yorkers are big  
that there is no room in the heart of New York  
for the kind of anti-Semitism, the kind of Islamophobia  
we have seen in our city in recent weeks.  
The hearts of the people who serve this city  
and this Body are big.  
God, please help them remember that.  
As they do their civic duty,

help them have strong backs and open hearts  
that they might make this city a beacon of justice,  
of compassion, and of safety for all.  
Amen.

Council Member Menin moved to spread the Invocation in full upon the record.

### **ADOPTION OF MINUTES**

On behalf of Council Member Barron, the Majority Leader and Acting President Pro Tempore (Council Member Powers) moved that the Minutes of the Stated Meetings of November 2, 2023 and November 15, 2023 be adopted as printed.

### **COMMUNICATION FROM CITY, COUNTY & BOROUGH OFFICES**

M-181

**Communication from the Comptroller – Submitting the projection of the City’s debt-incurring power for Fiscal Years 2024-2027, pursuant to Section 232 of the New York City Charter.**

December 1, 2023

The Honorable Adrienne Adams  
Speaker  
City Council  
The City of New York  
City Hall  
New York, New York 10007

Dear Speaker Adams:

In accordance with Section 232 of the New York City Charter, enclosed please find the projection of the City's debt-incurring power for Fiscal Years 2024-2027.

Sincerely,

Brad Lander  
New York City Comptroller

Attachment

Received, Ordered, Printed and Filed.

## REPORTS OF THE STANDING COMMITTEES

### Report of the Committee on Civil and Human Rights

Report for Int. No. 1101-A

#### **Report of the Committee on Civil and Human Rights in favor of approving and adopting, as amended, a Local Law to amend the New York city charter, in relation to anti-racism training for human services contractors.**

The Committee on Civil and Human Rights, to which the annexed proposed amended local law was referred on June 22, 2023 (Minutes, page 1898), respectfully

#### REPORTS:

#### **INTRODUCTION**

On December 6, 2023, the Committee on Civil and Human Rights, chaired by Council Member Nantasha Williams, held a vote on Proposed Int. 1101-A, in relation to anti-racism training for human services contractors and Proposed Int. 1118-A, in relation to anti-racism discrimination trainings for employees, interns, independent contractors, and volunteers of city agencies. A previous version of each bill was heard by the Committee on September 19, 2023, during a joint hearing with the Committee on Cultural Affairs, Libraries, and International Intergroup Relations. Those invited to testify included the New York City Commission on Human Rights (CCHR), the Mayor's Office of Equity (MOE), the New York City Public Design Commission (PDC), the New York City Department of Citywide Administrative Services (DCAS), the Mayor's Office of Nonprofit Services (MONS), advocates, community organizations, and members of the public. Testimony from those in attendance at hearing, as well as ongoing feedback, has informed the amendments to these bills. The bills passed with 4 votes in the affirmative, 0 votes in the negative, and no abstentions.

#### **I. BACKGROUND**

For over 200 years, the City of New York legally sanctioned the wrongful<sup>1</sup> enslavement of human beings of African and indigenous American descent. After slavery was banned statewide in 1827, racially motivated discrimination, segregation and violence continued, not only overtly in practice but inherently through formal laws and policies.<sup>2</sup>

Legacies of slavery and racial discrimination continue to the present day, including stark disparities in access to employment opportunities and fair wages for Black New Yorkers that persist across dozens of industries.<sup>3</sup>

<sup>1</sup> The prohibition against slavery is a universal principle of international law recognized in the Universal Declaration of Human Rights and the International Covenant on Civil and Political Rights, which the United States ratified in 1992. See *International Law and Agreements: Their Effect upon U.S. Law*, CONGRESSIONAL RESEARCH SERVICE (updated July 13, 2023), <https://crsreports.congress.gov/product/pdf/RL/RL32528>; United Nations, *Ratification Status for International Covenant on Civil and Political Rights*, [https://tbinternet.ohchr.org/\\_layouts/15/TreatyBodyExternal/Treaty.aspx?Treaty=CCPR&Lang=en](https://tbinternet.ohchr.org/_layouts/15/TreatyBodyExternal/Treaty.aspx?Treaty=CCPR&Lang=en); *The Core International Human Rights Treaties*, UN Office of the High Commissioner for Human Rights, <https://www.ohchr.org/sites/default/files/documents/publications/coretreatiesen.pdf>.

<sup>2</sup> For example, segregation was widespread and legally sanctioned in New York before and after the Civil War, until the northern civil rights movement led to . Martha Biondi, "How does New York change the story of the Civil Rights Movement?", *Afro-Americans in New York Life and History* (2007), [https://www.nyc.gov/html/cchr/justice/downloads/pdf/how\\_new\\_york\\_changes\\_the\\_civil\\_rights\\_movement.pdf](https://www.nyc.gov/html/cchr/justice/downloads/pdf/how_new_york_changes_the_civil_rights_movement.pdf).

<sup>3</sup> Jonathan Bowles, Eli Dvorkin, and Charles Shaviro, *Stark Disparities in Employment and Wages for Black New Yorkers* (2020), CENTER FOR AN URBAN FUTURE, <https://nycfuture.org/research/stark-disparities-in-employment-and-wages-for-black-new-yorkers>.

Likewise, the social support systems that many New Yorkers rely on have been shown to perpetuate and at times contribute to systemic racial inequities.<sup>4</sup>

In the City's ongoing effort toward dismantling these systems, the Racial Justice Commission (RJC), established in 2021, released a roadmap intended to guide the City's efforts to eliminate structural barriers to racial equity.<sup>5</sup> In its reports, the RJC identified racial inequities in access to high-quality socioemotional services, inequities in work and wealth-building, and inequities in government accountability to BIPOC individuals and communities,<sup>6</sup> and recommended devoting resources to improving and strengthening accountability for racial equity commitments; to implementing anti-discrimination measures; and to ensuring equitable access to essential living standards and rights.<sup>7</sup>

## II. LEGISLATIVE ANALYSIS

### *a. Prop. Int. 1101-A – A Local Law to amend the New York city charter, in relation to anti-racism training for human services contractors*

This bill would amend the City's Charter to require the Chief Equity Officer to create an interactive anti-racism training for employees of human services contractors who directly render services to the public, as well as their supervisors. The training would not need to be facilitated by a live or in-person instructor, but must be available online, on demand and free of charge. The purpose of the training would be to improve the provision of human services in the City by: (1) providing contractors with tools for serving individuals from diverse backgrounds; (2) improving awareness of, and sensitivity to, how racism and related injustices impact the provision of human services; and (3) promoting policies, practices, and norms designed to combat racism and advance racial equity in the provision of human services. The trainings must be completed at least once annually, and the Chief Equity Officer must provide certificates of completion to employees who do so. As an alternative, human services contractors would be able to meet this requirement by offering their own anti-racism training curriculum to employees, where approved by the Chief Equity Officer. Such alternative trainings must meet the same statutory requirements as apply to the City-developed trainings. Human services contractors must maintain records of their compliance with these training requirements.

### *b. Prop Int. 1118-A – A Local Law to amend the New York city charter, in relation to anti-racism and anti-racial discrimination trainings for employees, interns, independent contractors, and volunteers of city agencies*

This bill would amend the City's Administrative Code to require the Department of Citywide Administrative Services (DCAS), in consultation with MOE and CCHR, to create an interactive anti-racism and anti-racial discrimination training for agency employees. The training would not need to be facilitated by a live or in-person instructor. Trainings may be tailored to the various work duties and environments of different groups of agency employees. Agencies may also design their own trainings that meet these requirements, provided that they obtain approval from DCAS every five years. Each employee of the City would be required to complete such training annually.

---

<sup>4</sup> See, e.g., Andy Newman, *Is N.Y.'s Child Welfare System Racist? Some of Its Own Workers Say Yes.*, N.Y. TIMES, Nov. 22, 2022, updated June 20, 2023, <https://www.nytimes.com/2022/11/22/nyregion/nyc-acs-racism-abuse-neglect.html>; Jenna Lauter, *Even "Child Welfare" Workers Say Their Agency Is Racist*, NYCLU, Jan. 23, 2023, <https://www.nyclu.org/en/news/even-child-welfare-workers-say-their-agency-racist-0>; Ife Floyd et al., *TANF Policies Reflect Racist Legacy of Cash Assistance*, CTR. ON BUDGET & POLICY PRIORITIES, Aug. 4, 2021, <https://www.cbpp.org/research/income-security/tanf-policies-reflect-racist-legacy-of-cash-assistance>.

<sup>5</sup> See <https://racialjustice.cityofnewyork.us/about/more-info-about-rjc-and-charter/>; NYC for Racial Justice: An Interim Report from the Racial Justice Commission Staff (cityofnewyork.us); NYC FOR RACIAL JUSTICE: FINAL REPORT OF THE NYC RACIAL JUSTICE COMMISSION (cityofnewyork.us).

<sup>6</sup> The remaining findings included inequity within and across neighborhoods; marginalization and over-criminalization of persons and communities that are black, indigenous, or of color ("BIPOC"); and inequities in political power and representation. NYC for Racial Justice: An Interim Report from the Racial Justice Commission Staff (cityofnewyork.us)

<sup>7</sup> NYC FOR RACIAL JUSTICE: FINAL REPORT OF THE NYC RACIAL JUSTICE COMMISSION (cityofnewyork.us)

(The following is the text of the Fiscal Impact Statement for Int. No. 1101-A:)

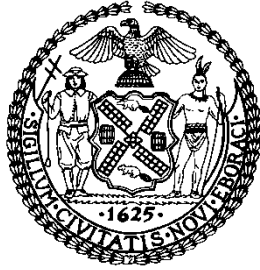

**THE COUNCIL OF THE CITY OF NEW YORK  
FINANCE DIVISION**

**TANISHA S. EDWARDS, ESQ., CHIEF FINANCIAL OFFICER, AND DEPUTY CHIEF OF STAFF TO THE SPEAKER**

**RICHARD LEE, FINANCE DIRECTOR**

**FISCAL IMPACT STATEMENT**

**PROPOSED INTRO. NO: 1101-A**

**COMMITTEE: Civil and Human Rights**

**TITLE:** A Local Law to amend the New York city charter, in relation to anti-racism training for human services contractors.

**SPONSOR(S):** Council Members Farias, Louis, Richardson Jordan, Hanif, Restler, Sanchez, Hudson, Narcisse, Avilés, Cabán, Menin, Schulman, Brooks-Powers, Krishnan, Nurse, Riley, Gennaro, Williams and Rivera.

**SUMMARY OF LEGISLATION:** This bill would require the Chief Equity Officer, in consultation with key stakeholders, to create an anti-racism training for employees of human services contractors. The purpose of such training would be to improve the provision of human services in the City by (1) providing contractors with tools for serving individuals from diverse backgrounds, (2) improving awareness of, and sensitivity to, how racism and related injustices impact the provision of human services, and (3) promoting policies, practices, and norms designed to combat racism and advance racial equity in the provision of human services. Each employee of a human services contractor would be required to complete such training annually. As an alternative, human services contractors would be able to meet this requirement by offering their own anti-racism training curriculum, where approved by the Chief Equity Officer.

**EFFECTIVE DATE:** This local law would take effect July 1, 2025.

**FISCAL YEAR IN WHICH FULL FISCAL IMPACT ANTICIPATED:** Fiscal Year 2025

**FISCAL IMPACT STATEMENT:**

	<b>Effective FY26</b>	<b>Succeeding FY27</b>	<b>Full Fiscal Impact FY26</b>
<b>Revenues (+)</b>	\$0	\$0	\$0
<b>Expenditures (-)</b>	\$19,000	\$0	\$0
<b>Net</b>	\$19,000	\$0	\$0

**IMPACT ON REVENUES:** It is anticipated that there would be no impact on revenues resulting from the enactment of this legislation.

**IMPACT ON EXPENDITURES:** It is anticipated that there would be a one-time cost of \$19,000 in Fiscal 2025 associated with the enactment of this legislation. The funding will be used by DCAS to develop the training program.

**SOURCE OF FUNDS TO COVER ESTIMATED COSTS:** N/A

**SOURCE OF INFORMATION:** NYC Office of Management and Budget

**ESTIMATE PREPARED BY:** Nia Hyatt, Senior Financial Analyst

**ESTIMATE REVIEWED BY:** Florentine Kabore, Unit Head  
 Crilhien Francisco, Assistant Director  
 Elizabeth Hoffman, Assistant Director  
 Chima Obichere, Deputy Director  
 Jonathan Rosenberg, Managing Deputy Director  
 Kathleen Ahn, Counsel

**LEGISLATIVE HISTORY:** This legislation was first introduced to the Council on June 22, 2023 as Intro. No. 1101 and was referred to the Committee on Civil and Human Rights (the Committee). A joint hearing was held by the Committee and the Committee on Cultural Affairs, Libraries and International Intergroup Relations on September 19, 2023, and the bill was laid over. The legislation was subsequently amended, and the amended version, Proposed Intro. No. 1101-A will be considered by the Committee on December 6, 2023. Upon successful vote by the Committee, Proposed Intro. No. 1101-A will be submitted to the full Council for a vote on December 6, 2023.

**DATE PREPARED** 11/8/2023.

(For text of Int. No. 1118-A and its Fiscal Impact Statement, please see the Report of the Committee on Civil and Human Rights for Int. No. 1118-A printed in these Minutes; for text of Int. No. 1101-A, please see below)

*Accordingly, this Committee recommends the adoption of Int. Nos. 1101-A and 1118-A.*

**(The following is the text of Int. No. 1101-A:)**

Int. No. 1101-A

By Council Members Farías, Louis, Richardson Jordan, Hanif, Restler, Sanchez, Hudson, Narcisse, Avilés, Cabán, Menin, Schulman, Brooks-Powers, Krishnan, Nurse, Riley, Gennaro, Williams, Rivera, Dinowitz and Salamanca.

**A Local Law to amend the New York city charter, in relation to anti-racism training for human services contractors**

*Be it enacted by the Council as follows:*

Section 1. Chapter 78 of the New York city charter is amended by adding a new section 3405 to read as follows:

*§ 3405 Anti-racism training for human services contractors. a. Definitions. For purposes of this section, the following terms have the following meanings:*

*Covered employee. The term “covered employee” means an employee of a human services contractor who directly renders human services to members of the public in performance of a human services contract, or an employee who supervises such an employee.*

*Human services.* The term “human services” means any social services provided to members of the public including, but not necessarily limited to, day care, foster care, home care, health or medical services, housing and shelter assistance, preventive services, youth services, the operation of senior centers, employment training and assistance, vocational and educational programs, legal services, and recreation programs.

*Human services agency.* The term “human services agency” means any covered agency that provides, or contracts for the provision of, human services.

*Human services contract.* The term “human services contract” means a written agreement, other than an emergency contract procured pursuant to section 315, between a contractor and a human services agency, the principal purpose of which is to provide human services.

*Human services contractor.* The term “human services contractor” means any contractor that enters into a human services contract with a human services agency. A person shall be deemed a human services contractor for the duration of the human services contract that such contractor enters into.

*Interactive training.* The term “interactive training” means a participatory training program whereby the trainee is actively engaged in a trainer-trainee interaction through the use of questions or other participatory methods as determined by the chief equity officer, provided that an “interactive training” need not be live or facilitated by an in-person instructor.

b. The chief equity officer, in consultation with the commissioner of citywide administrative services, the head of each human services agency, and representatives from human services contractors, shall create and regularly update an anti-racism training for covered employees. Such training shall be an interactive training, the purpose of which shall be to improve the provision of human services in the city, including by:

1. Providing covered employees with tools to adequately serve individuals from diverse backgrounds, including members of marginalized groups;
2. Helping covered employees improve awareness of, and sensitivity to, how racism and related injustices impact the provision of human services in the city; and
3. Promoting policies, practices, and norms designed to combat racism and advance racial equity in the provision of human services in the city.

c. The chief equity officer, in consultation with the commissioner of citywide administrative services, the head of each human services agency, and representatives from human services contractors, may create a unique version of such training for any particular group of covered employees to ensure that:

1. The information covered is appropriately tailored to the work of such employees in light of their relevant professional responsibilities, the particular services they provide, or the populations they serve; and
2. The training avoids duplication with other trainings such employees are required to complete pursuant to federal, state, or local law.

d. The chief equity officer shall ensure that:

1. Such training is available as an online interactive training that can be completed on demand and free of charge on the website of the office of racial equity; and
2. Those who complete such online interactive training are provided with an electronic certification of such completion.

e. The chief equity officer may also make such training available as in-person interactive training, provided that the chief equity officer also provides those who complete such in-person training with a certification of such completion.

f. Each human services contractor shall:

1. Ensure that covered employees of such contractor complete such training at least once per year; and
2. Maintain records showing compliance with this section.

g. The chief equity officer shall create a process by which human services contractors that are subject to training requirements in multiple jurisdictions, or that otherwise provide an alternative annual interactive anti-racism training to all covered employees, may certify their compliance with this section, provided that such alternative training meets the requirements of subdivision b of this section.

§ 2. This local law takes effect on July 1, 2025.



NANTASHA M. WILLIAMS, *Chairperson*; RAFAEL SALAMANCA, Jr., RITA C. JOSEPH, CHRISTOPHER MARTE; 4-0-0; *Absent*: Council Member Richardson Jordan; Committee on Civil and Human Rights, December 6, 2023. *Other Council Members Attending: Council Member Farías.*

On motion of the Speaker (Council Member Adams), and adopted, the foregoing matter was coupled as a General Order for the day (see ROLL CALL ON GENERAL ORDERS FOR THE DAY).

Report for Int. No. 1118-A

**Report of the Committee on Civil and Human Rights in favor of approving and adopting, as amended, a Local Law to amend the New York city charter, in relation to anti-racism and anti-racial discrimination trainings for employees, interns, independent contractors, and volunteers of city agencies.**

The Committee on Civil and Human Rights, to which the annexed proposed amended local law was referred on June 22, 2023 (Minutes, page 1945), respectfully

**REPORTS:**

(For text of report, please see the Report of the Committee on Civil and Human Rights for Int. No. 1101-A printed above in these Minutes)

*The following is the text of the Fiscal Impact Statement for Int. No. 1118-A:*

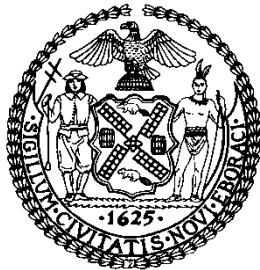

**THE COUNCIL OF THE CITY OF NEW YORK**

**FINANCE DIVISION**

**TANISHA S. EDWARDS, ESQ., CHIEF FINANCIAL OFFICER, AND DEPUTY CHIEF OF STAFF TO THE SPEAKER**

**RICHARD LEE, FINANCE DIRECTOR**

**FISCAL IMPACT STATEMENT**

**PROPOSED INTRO. NO: 1118-A**

**COMMITTEE: Civil and Human Rights**

**TITLE:** A Local Law to amend the New York city charter, in relation to anti-racism and anti-racial discrimination trainings for employees, interns, independent contractors, and volunteers of city agencies.

**SPONSOR(S):** Council Members Williams, Louis, Richardson Jordan, Farías, Stevens, Hanif, Restler, Sanchez, Narcisse, Avilés, Cabán, Menin, Brooks-Powers, Krishnan, Nurse, Riley, Gennaro and Rivera.

**SUMMARY OF LEGISLATION:** This bill would require the Department of Citywide Administrative Services, in consultation with the Office of Racial Equity and the Commission on Human Rights, to create an anti-racism

and anti-racial discrimination training for agency employees, defined as including agency interns, independent contractors, and volunteers. Each employee of the City would be required to complete such training at least once per year.

**EFFECTIVE DATE:** This local law would take effect on July 1<sup>st</sup>, 2025

**FISCAL YEAR IN WHICH FULL FISCAL IMPACT ANTICIPATED:** Fiscal Year 2025

---

**FISCAL IMPACT STATEMENT:**

	<b>Effective FY26</b>	<b>Succeeding FY27</b>	<b>Full Fiscal Impact FY26</b>
<b>Revenues (+)</b>	\$0	\$0	\$0
<b>Expenditures (-)</b>	\$0	\$0	\$0
<b>Net</b>	\$0	\$0	\$0

**IMPACT ON REVENUES:** It is anticipated that there would be no impact on revenues resulting from the enactment of this legislation.

**IMPACT ON EXPENDITURES:** It is anticipated that there would be no impact on expenditures resulting from the enactment of this legislation, as agencies responsible for carrying out its requirements will utilize existing resources to fulfill its requirements.

**SOURCE OF FUNDS TO COVER ESTIMATED COSTS:** N/A

**SOURCE OF INFORMATION:** Commission on Human Rights

**ESTIMATE PREPARED BY:** Nia Hyatt, Senior Financial Analyst

**ESTIMATE REVIEWED BY:** Florentine Kabore, Unit Head  
Cirilhien Francisco, Assistant Director  
Elizabeth Hoffman, Assistant Director  
Chima Obichere, Deputy Director  
Jonathan Rosenberg, Managing Deputy Director  
Kathleen Ahn, Counsel

**LEGISLATIVE HISTORY:** This legislation was first introduced to the Council on June 22<sup>nd</sup>, 2023 as Intro. No. 1118 and was referred to the Committee on Civil and Human Rights (the Committee). A joint hearing was held by the Committee and the Committee on Cultural Affairs, Libraries and International Intergroup Relations on September 19<sup>th</sup>, 2023, and the bill was laid over. The legislation was subsequently amended, and the amended version, Proposed Intro. No.1118-A will be considered by the Committee on December 6<sup>th</sup>, 2023. Upon successful vote by the Committee, Proposed Intro. No. 1118-A will be submitted to the full Council for a vote on December 6<sup>th</sup>, 2023.

**DATE PREPARED:** 11/30/2023.

*Accordingly, this Committee recommends its adoption, as amended.*

**(The following is the text of Int. No. 1118-A:)**

## Int. No. 1118-A

By Council Members Williams, Louis, Richardson Jordan, Farías, Stevens, Hanif, Restler, Sanchez, Narcisse, Avilés, Cabán, Menin, Brooks-Powers, Krishnan, Nurse, Riley, Gennaro, Rivera, Dinowitz and Salamanca

**A Local Law to amend the New York city charter, in relation to anti-racism and anti-racial discrimination trainings for employees, interns, independent contractors, and volunteers of city agencies**

*Be it enacted by the Council as follows:*

Section 1. Chapter 35 of the New York city charter is amended by adding a new section 815.3 to read as follows:

§ 815.3 *Anti-racism and anti-racial discrimination trainings. a. Definitions. For purposes of this section, the terms “agency” and “interactive training” have the same meanings as in section 815.1.*

*Employee. The term “employee” means employees, interns, independent contractors, and volunteers of city agencies.*

*Independent contractor. The term “independent contractor” means an independent contractor of an agency, or an employee thereof, who communicates with one or more city employees for at least one hour each week in work for the city which is anticipated to extend for not fewer than four weeks.*

*Volunteer. The term “volunteer” means an individual who, other than a city employee, is appointed to and serves without compensation on a board, commission, committee or other body created by law, rule or executive order, the expenses of which are paid in whole or part from the city treasury.*

*b. The department, in consultation with the office of racial equity and the commission on human rights, shall create and update, as necessary in the view of the department, an anti-racism and anti-racial discrimination training for agency employees. Such training shall be an interactive training, the purpose of which shall be to enable agency employees, including supervisory and managerial employees, to identify, respond to, and combat racism and racial discrimination in the workplace.*

*c. The department, in consultation with the office of racial equity and the commission on human rights, may create a unique version of such training for any particular group of agency employees to ensure that:*

*1. The information covered is relevant to such employees in light of their particular duties or work environment; and*

*2. The training avoids duplication with other trainings such employees are required to complete pursuant to federal, state, or local law.*

*d. Each agency, in consultation with the department, shall ensure that each of its employees completes such training at least once per year. Such training may be provided in combination with other trainings provided to the agency’s employees.*

*e. Notwithstanding any other provision of this section, an agency may satisfy its obligation pursuant to subdivision d of this section using an alternative training, provided that the department, in consultation with the office of racial equity and the commission on human rights, has reviewed and approved such training for such purpose. Any such approval shall be valid for no longer than 5 years.*

§ 2. This local law takes effect July 1, 2025.

NANTASHA M. WILLIAMS, *Chairperson*; RAFAEL SALAMANCA, Jr., RITA C. JOSEPH, CHRISTOPHER MARTE; 4-0-0; *Absent*: Council Member Richardson Jordan; Committee on Civil and Human Rights, December 6, 2023. *Other Council Members Attending: Council Member Farías.*

On motion of the Speaker (Council Member Adams), and adopted, the foregoing matter was coupled as a General Order for the day (see ROLL CALL ON GENERAL ORDERS FOR THE DAY).

**Report of the Committee on Cultural Affairs, Libraries and International Intergroup Relations**

Report for Int. No. 1184-A

**Report of the Committee on Cultural Affairs, Libraries and International Intergroup Relations in favor of approving and adopting, as amended, a Local Law to amend the New York city charter, in relation to requiring the commissioner of cultural affairs to report annually on department funding of art and cultural organizations and institutions.**

The Committee on Cultural Affairs, Libraries and International Intergroup Relations, to which the annexed proposed amended local law was referred on September 14, 2023 (Minutes, page 2418), respectfully

**REPORTS:**

**I. INTRODUCTION**

On Wednesday, December 6, 2023, the Committee on Cultural Affairs, Libraries and International Intergroup Relations, chaired by Council Member Chi Ossé, will hold a hearing and vote on Resolution Number (Res. No.) 813, sponsored by Council Member Amanda Farías, recognizing April 13 annually as Borinqueneers Day in the City of New York in honor of the courage and wartime contributions of the U.S. Army's 65th Infantry Regiment and their lasting legacy. The Committee will also vote on Proposed Introduction Number (Int. No.) 1184-A, sponsored by Council Member Ossé, to amend the New York city charter, in relation to requiring the Commissioner of Cultural Affairs (Commissioner) to report annually on the Department of Cultural Affairs' (Department) funding of art and cultural organizations and institutions, and on Res. No. 586, sponsored by Council Member Nantasha Williams, designating May 10 annually as National Pan-Hellenic Council Day in the City of New York to recognize the contributions made to social change by members of nine Black sororities and fraternities, known as the Divine Nine. Int. No. 1184 and Res. No. 568 were originally heard on September 26, 2023.

**II. LEGISLATIVE ANALYSIS**

***Proposed Int. No. 1184-A***

This bill would require the Commissioner to submit to the Speaker of the Council and post on the Department's website a report containing information regarding the Department's spending to support art and cultural organizations and institutions, as well as the Department's spending on direct agency expenses. This bill would require the report to include the Council District, ZIP code, and community board for each organization.

Since being heard, this bill received technical edits. This bill was also amended to require the Commissioner to report demographic information pertaining to the communities served by Department-funded arts and cultural organizations. Such information would include race/ethnicity, age, disability status, and sexual orientation, if known to the Department. Additionally, the Commissioner would be required to report demographic information pertaining to the leaders of such organizations, if disclosed to the Department for purposes of the report.

**(The following is the text of the Fiscal Impact Statement for Int. No. 1184-A:)**

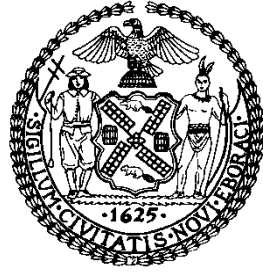

**THE COUNCIL OF THE CITY OF NEW YORK**

**FINANCE DIVISION**

**TANISHA EDWARDS, CHIEF FINANCIAL OFFICER  
AND DEPUTY CHIEF OF STAFF TO THE SPEAKER**

**RICHARD LEE, DIRECTOR**

**FISCAL IMPACT STATEMENT**

**PROPOSED INT. NO. 1184-A**

**COMMITTEE:** Cultural Affairs, Libraries and International Intergroup Relations

**TITLE:** A Local Law to amend the New York city charter, in relation to requiring the department of cultural affairs to report annually on department funding of art and cultural organizations and institutions.

**Sponsors:** Council Members Ossé, Gutiérrez, Louis, Schulman, Hanif, Nurse, Won, Menin, Abreu, Riley, Brewer, Krishnan, Cabán, Ung, Marte, Hudson and Rivera.

**SUMMARY OF LEGISLATION:** This bill would require the Department of Cultural Affairs (DCLA) to submit to the Speaker of the Council and post on its website a report containing information regarding DCLA’s spending to support art and cultural organizations and institutions. The information required by the report would include both geographical and demographic information relating to the organizations, as well as the amount of funds used. The report would be required no later than September 30, 2024, and on or before September 30 annually thereafter.

**EFFECTIVE DATE:** This local law takes effect immediately.

**FISCAL YEAR (FY) IN WHICH FULL FISCAL IMPACT ANTICIPATED: FY25**

**FISCAL IMPACT STATEMENT:**

	<b>Effective FY24</b>	<b>Succeeding FY25</b>	<b>Full Fiscal Impact FY25</b>
<b>Revenues (+)</b>	\$0	\$0	\$0
<b>Expenditures (-)</b>	\$0	\$0	\$0
<b>Net</b>	\$0	\$0	\$0

**IMPACT ON REVENUES:** It is estimated that there would be no impact on revenues resulting from the enactment of this legislation.

**IMPACT ON EXPENDITURES:** It is estimated that there would be no impact on expenditures resulting from the enactment of this legislation, as the agency responsible for carrying out its requirements would use existing resources.

**SOURCE OF FUNDS TO COVER ESTIMATED COSTS: N/A**

**SOURCE OF INFORMATION:** New York City Council Finance Division  
Mayor's Office of City Legislative Affairs

**ESTIMATE PREPARED BY:** Sandra Gray, Financial Analyst

**ESTIMATE REVIEWED BY:** Aliya Ali, Unit Head  
Chima Obichere, Deputy Director  
Kathleen Ahn, Finance Division Counsel  
Jonathan Rosenberg, Managing Deputy Director

**LEGISLATIVE HISTORY:** The legislation was introduced to the full Council on September 14, 2023, as Intro. No. 1184 and referred to the Committee on Cultural Affairs, Libraries and International Intergroup Relations (the Committee). The legislation was considered by the Committee at a hearing held on September 26, 2023, and laid over. The legislation was subsequently amended, and the amended version, Proposed Intro. No. 1184-A will be considered by the Committee on, December 6, 2023. Upon successful vote by the Committee, Proposed Intro. No. 1184-A will be submitted to the full Council for a vote on, December 6, 2023.

**DATE PREPARED:** 12/4/2023.

**(For text of Res. Nos. 568 and 813, please see the Reports of the Committee on Cultural Affairs, Libraries and International Intergroup Relations for Res. Nos. 568 and 813, respectively, printed in the voice-vote Resolutions calendar section of these Minutes; for text of Int. No. 1184-A, please see below)**

*Accordingly, this Committee recommends the adoption of Int. No. 1184-A and Res. Nos. 568 and 813.*

**(The following is the text of Int. No. 1184-A:)**

Int. No. 1184-A

By Council Members Ossé, Gutiérrez, Louis, Schulman, Hanif, Nurse, Won, Menin, Abreu, Riley, Brewer, Krishnan, Cabán, Ung, Marte, Hudson, Rivera, Gennaro and Narcisse.

**A Local Law to amend the New York city charter, in relation to requiring the commissioner of cultural affairs to report annually on department funding of art and cultural organizations and institutions**

*Be it enacted by the Council as follows:*

Section 1. Chapter 67 the New York city charter is amended by adding a new section 2510 to read as follows:  
§ 2510. *Funding for arts and cultural organizations and institutions. a. Definitions. For purposes of this section, the following terms have the following meanings:*

*Capacity-building funding. The term "capacity-building funding" means funding to help small, community-based organizations serving low-to-moderate income populations provide arts or cultural programming to members of the public.*

*Capital funding. The term "capital funding" means funding to support design and construction projects or to purchase or lease major equipment or machinery, such as vehicles or computers.*

*Commissioner. The term "commissioner" means the commissioner of cultural affairs.*

*Cultural institution funding. The term "cultural institution funding" means funding provided to a cultural institution in the cultural institutions group.*

*Cultural institutions group. The term "cultural institutions group" has the same meaning as set forth in section 2507.*

*Department. The term "department" means the department of cultural affairs.*

*Program funding. The term "program funding" means grant funding for a nonprofit organization to provide*

*arts or cultural programming to members of the public.*

*b. No later than September 30, 2024, and no later than September 30 of each year thereafter, the commissioner shall submit to the mayor and the speaker of the council, and post on the department's website, a report on funding provided by the department to arts and cultural organizations and institutions during the prior fiscal year. Such report shall include, but need not be limited to, the following information:*

*1. The name of each organization or institution that received funds from the department during the prior fiscal year, and for each such organization or institution:*

*(a) The zip code, borough, community board, and council district in which such organization or institution's offices are located;*

*(b) The amount of funds the department provided to such organization or institution during such fiscal year, and for each such amount, the type of funds provided, including but not limited to program funding, cultural institution funding, capital funding, and capacity-building funding;*

*(c) If provided to the department, the percentage of individuals served by such organization or institution that identify as (i) Black, indigenous, or people of color, including individuals who identify as Native American, Native Hawaiian, Alaskan Native, Desi, Asian, Pacific Islander, Chicanx, or Latinx, (ii) immigrants, (iii) people with disabilities, (iv) seniors, or (v) lesbian, gay, bisexual, transgender, queer, intersex, or asexual; and*

*(d) The name of the leader of such organization or institution and the demographic information of such leader, if such information is disclosed to the department for purposes of the report required by this subdivision;*

*2. The total amount of funds used for staff and operating costs of the department during the prior fiscal year;*

*3. A summary description of any trends or significant changes to funding provided by the department to arts and cultural organizations and institutions; and*

*4. A description of any challenges to obtaining data needed to produce the report required by this subdivision.*

§ 2. This local law takes effect immediately.

CHI A. OSSÉ, *Chairperson*; FRANCISCO P. MOYA, FARAH N. LOUIS, ERIC DINOWITZ, AMANDA FARÍAS, SHAHANA K. HANIF, CRYSTAL HUDSON, RITA C. JOSEPH; 8-0-0, *Medical*: Sandra Ung; Committee on Cultural Affairs, Libraries and International Intergroup Relations, December 6, 2023.

On motion of the Speaker (Council Member Adams), and adopted, the foregoing matter was coupled as a General Order for the day (see ROLL CALL ON GENERAL ORDERS FOR THE DAY).

## Report of the Committee on Education

Report for Int. No. 198-A

### **Report of the Committee on Education in favor of approving and adopting, as amended, a Local Law to amend the administrative code of the city of New York, in relation to requiring the department of education to stock opioid antagonists in all school buildings.**

The Committee on Education, to which the annexed proposed amended local law was referred on April 14, 2022 (Minutes, page 618), respectfully

#### REPORTS:

##### **I. Introduction**

On December 5, 2023, the Committee on Education, chaired by Council Member Rita Joseph, will consider Proposed Introduction Number (“Int. No.”) 198-A, sponsored by Council Member Rafael Salamanca, related to requiring the department of education (DOE) to stock opioid antagonists in all school buildings; Proposed Resolution Number (“Res. No.”) 534-A, sponsored by Council Member Rita Joseph, calling on the New York State Legislature to pass, and the New York State Governor to sign, A.3723/S.759 and A.816/S.879, which would extend the hours of use for student MetroCards in New York City and would prohibit the Metropolitan Transportation Authority from promulgating rules or regulations that penalize a student for using a student MetroCard when school is not in session; Res. No. 579, sponsored by Council Member Eric Dinowitz, calling on the New York City (NYC) DOE to ensure that the New York State Seal of Biliteracy is awarded in all NYC public high schools to eligible students; Res No. 742, sponsored by Council Member Shaun Abreu, calling on the NYC DOE to develop curriculum on machine learning, and adapt their current curriculum and policies to account for the safe use of generative AI; Res. No. 766, sponsored by Council Member Rita Joseph, calling on the NYC DOE to update its CS4All initiative to increase access to CS4All professional development for educators and administrators, particularly for those in underserved schools, and to increase training for all teachers; and Res. No. 767, sponsored by Council Member Rita Joseph, calling on the NYC DOE to mandate training on generative artificial intelligence tools, including for potential classroom implementation, for all educators.

The Committee previously held a hearing on Int. No. 198 on April 19, 2023; Proposed Res. No. 534-A on October 25, 2023; Res. No. 579 on October 18, 2023; and Res. No. 742, 766, and 767 on September 20, 2023. At the hearings, the Committee heard testimony from the DOE, community-based organizations, service providers and members of the public.

##### **II. Bill Analysis**

#### **Proposed Int. No. 198-A – A Local Law to amend the administrative code of the city of New York, in relation to requiring the department of education to stock opioid antagonists in all school buildings**

The United States is in the midst of an opioid epidemic—opioid-involved death rates have increased significantly since the beginning of the pandemic and according to the Center for Disease Control and Prevention, in 2019, nearly 1 in 7 students reported ever misusing prescription opioids.<sup>1</sup>

This bill would mandate that the DOE stock opioid antagonists (generic name Naloxone; brand name Narcan) in all school buildings with an assigned nurse as well as report on the number of such schools stocked and the number of instances opioid antagonists were administered to an individual in a school building.

---

<sup>1</sup> Centers for Disease Control and Prevention, “Teen Newsletter: Opioids,” July 2022, *available at* <https://www.cdc.gov/museum/education/newsletter/2022/july/index.html>.



Since it was heard, this bill was amended to include all schools buildings with an assigned nurse and require reporting on the number of schools stocked as well as the use of opioid antagonists in such schools. This bill also received technical edits.

**(The following is the text of the Fiscal Impact Statement for Int. No. 198-A:)**

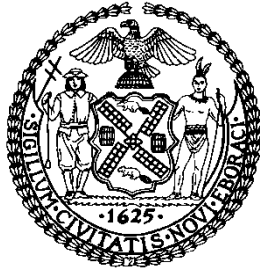

**THE COUNCIL OF THE CITY OF NEW YORK**

**FINANCE DIVISION**

**TANISHA S. EDWARDS, ESQ., CFO, AND DEPUTY CHIEF OF STAFF TO THE SPEAKER**

**RICHARD LEE, DIRECTOR**

**FISCAL IMPACT STATEMENT**

**PROPOSED INTRO. NO: 198-A**

**COMMITTEE: EDUCATION**

**TITLE:** A Local Law to amend the administrative code of the city of New York, in relation to requiring the department of education to stock opioid antagonists in all school buildings.

**SPONSOR(S):** Council Members Salamanca, Cabán, Stevens, Hanif, Won, Restler, Krishnan, Nurse, Abreu, Sanchez, Powers, Gennaro, Riley, Louis, Lee and Rivera.

**SUMMARY OF LEGISLATION:** This bill would mandate that the department of education stock opioid antagonists in all school buildings with an assigned nurse as well as report on the number of schools stocked and the number of instances opioid antagonists were administered to an individual in a school building.

**EFFECTIVE DATE:** This local law would take effect 60 days after it becomes law.

**FISCAL YEAR IN WHICH FULL FISCAL IMPACT ANTICIPATED:** Fiscal 2026

**FISCAL IMPACT STATEMENT:**

	<b>Effective FY24</b>	<b>FY Succeeding Effective FY25</b>	<b>Full Fiscal Impact FY26</b>
<b>Revenues</b>	\$0	\$0	\$0
<b>Expenditures</b>	\$93,500	(See Below)	\$126,000
<b>Net</b>	\$93,500	(See Below)	\$126,000

**IMPACT ON REVENUES:** It is anticipated that there would be no impact on revenues resulting from the enactment of this legislation.

**IMPACT ON EXPENDITURES:** It is anticipated that there would be an initial cost of \$93,500 to stock and train middle and elementary school buildings and staff on usage of opioid antagonists. High Schools are already equipped to provide naloxone prevention kits. It would cost an additional \$126,000 every two years to replace expired naloxone kits and train new staff in all school buildings.

**SOURCE OF FUNDS TO COVER ESTIMATED COSTS:** General Fund

**SOURCE OF INFORMATION:** New York City Council Finance Division  
New York City Department of Health and Mental Hygiene

**ESTIMATE PREPARED BY:** Monica Saladi, Principal Financial Analyst

**ESTIMATE REVIEWED BY:** Kathleen Ahn, Counsel  
Aliya Ali, Unit Head  
Elizabeth Hoffman, Assistant Director  
Chima Obichere, Deputy Director  
Jonathan Rosenberg, Managing Deputy Director

**LEGISLATIVE HISTORY:** This legislation was first introduced by the Council, as Intro. No. 198 and referred to the Committee on Education (Committee) on April 14, 2022. The Committee heard the legislation on April 19, 2023 and the legislation was laid over. The legislation was subsequently amended, and the amended version, Proposed Intro. No. 198-A, will be considered by the Committee on December 5, 2023. Upon a successful vote by the Committee, Proposed Int. No. 198-A will be submitted to the full Council for a vote on December 6, 2023.

**DATE PREPARED:** November 29, 2023.

(For text of Res. Nos. 534-A, 579, 742, 766, and 767, please see the Report of the Committee on Education for Res. Nos. 534-A, 579, 742, 766, and 767, respectively, printed in the voice-vote Resolutions calendar section of these Minutes; for text of Int. No. 198-A, please see below)

*Accordingly, this Committee recommends the adoption of Int. No. 198-A and Res. Nos. 534-A, 579, 742, 766, and 767.*

**(The following is the text of Int. No. 198-A:)**

Int. No. 198-A

By Council Members Salamanca, Cabán, Stevens, Hanif, Won, Restler, Krishnan, Nurse, Abreu, Sanchez, Powers, Gennaro, Riley, Louis, Lee, Rivera, Hanks, Joseph and Narcisse.

**A Local Law to amend the administrative code of the city of New York, in relation to requiring the department of education to stock opioid antagonists in all school buildings**

*Be it enacted by the Council as follows:*

Section 1. Title 21-A of the administrative code of the city of New York is amended by adding a new chapter 34 to read as follows:

*CHAPTER 34  
OPIOID OVERDOSE PREVENTION*

*§ 21-1005 Opioid overdose prevention. a. Definitions. For purposes of this section, the following terms have the following meanings:*

*Opioid antagonist. The term “opioid antagonist” has the same meaning as set forth in section 3309 of the public health law.*

*School building. The term “school building” means any facility that is leased by the department or over which the department has care, custody, and control, in which there is a public school.*

*b. The department shall stock opioid antagonists in all school buildings with school nurses assigned and consistent with section 3309 of the public health law.*

*c. No later than September 30, 2024, and annually thereafter, the department shall submit to the mayor and the speaker of the council a report that shall include, for the prior school year:*

- 1. The number of school buildings stocked with at least 1 opioid antagonist kit; and*
- 2. The number of instances that an opioid antagonist from such stocked kit was administered to an individual in a school building.*

*§ 2. This local law takes effect 60 days after it becomes law.*

RITA C. JOSEPH, *Chairperson*; FARAH N. LOUIS, JAMES F. GENNARO, ERIC DINOWITZ, OSWALD FELIZ, ALEXA AVILÉS, CARMEN N. De La ROSA, SHAHANA K. HANIF, SHEKAR KRISHNAN, LINDA LEE, JULIE MENIN, MERCEDES NARCISSE, LINCOLN RESTLER, PIERINA ANA SANCHEZ, LYNN C. SCHULMAN, SANDRA UNG; 16-0-0; *Absent*: Jennifer Gutiérrez, Kamillah Hanks, and Althea V. Stevens; Committee on Education, December 5, 2023.

On motion of the Speaker (Council Member Adams), and adopted, the foregoing matter was coupled as a General Order for the day (see ROLL CALL ON GENERAL ORDERS FOR THE DAY).

## Report of the Committee on Environmental Protection, Resiliency and Waterfronts

Report for Int. No. 774-A

**Report of the Committee on Environmental Protection, Resiliency and Waterfronts in favor of approving and adopting, as amended, a Local Law to amend the administrative code of the city of New York, in relation to requiring the department of environmental protection to measure construction-related sound levels inside dwelling units upon request and prohibited noise levels for sound attributable to construction devices on or after 7:00 a.m. and before 10 p.m.**

The Committee on Environmental Protection, Resiliency and Waterfronts, to which the annexed proposed amended local law was referred on October 12, 2022 (Minutes, page 2479), respectfully

### REPORTS:

#### I. INTRODUCTION

On December 6, 2023, the New York City Council Committee on Environmental Protection, Resiliency, and Waterfronts (the “Committee”), chaired by Council Member James F. Gennaro, will hold a hearing to vote on the following bills sponsored by Majority Leader Keith Powers: Proposed Int. No. 774-A, in relation to requiring the Department of Environmental Protection (“DEP”) to measure construction-related sound levels inside dwelling units upon request; Proposed Int. No. 775-A, in relation to the results of noise inspections; Proposed Int. No. 776-A, in relation to providing noise inspection reports; and Proposed Int. No. 778-A, in relation to establishing a photo noise violation monitoring device program for motor vehicles. Additionally, the Committee will vote on Proposed Int. No. 1194-A, sponsored by Council Member James Gennaro, in relation to compensation awarded by the Environmental Control Board (“ECB”) to complainants for citizen noise complaints and to the maximum penalty authorized for violations of subdivision (b) of section 24-244 of the administrative code for certain proceedings. Proposed Introduction Nos. 774-A, 775-A, 776-A, 778-A, and 1194-A were first heard by the Committee on October 16, 2023.

#### II. BACKGROUND

##### *Noise Pollution from Construction:*

DEP has the authority to inspect and issue violations for unreasonable construction noise and specific types of construction noise. Covered types of construction noise include noise produced by construction devices, noise produced by the transportation of construction materials, and noise produced by construction conducted pursuant to an after-hours variance, which is a permit that one must obtain in order to conduct certain construction work on a weekend or on a weekday before 7 a.m. or after 6 p.m.<sup>1</sup> Specifically, construction devices may not emit either: an impulsive sound 15 decibels or louder than the ambient sound level when measured at 15 feet or from within a residential property; or a sound, other than an impulsive sound, louder than 85 decibels when measured at 50 feet.<sup>2</sup> Noise from construction conducted pursuant to an after-hours variance may not exceed 7 decibels above ambient sound levels when measured within a receiving residential property with doors and windows shut, and such noise may not exceed 75 or 85 decibels when measured 50 or more feet from the source, depending on certain conditions.<sup>3</sup> Violations of the noise code for after-hours construction carries a civil penalty of \$875–\$10,500, and violations of the code for excessive noise from construction devices carry a penalty of \$440–

---

<sup>1</sup> Adm. Code § 24-223

<sup>2</sup> Adm. Code § 24-228

<sup>3</sup> Adm. Code § 24-223

\$4,200.<sup>4</sup> The exact amount of the penalties vary according to the number of offenses received and the discretion of the hearing officer who conducts the hearing through the Office of Administrative Trials and Hearings (“OATH”).

*Publication of Noise Complaint and Inspection Results:*

New Yorkers may struggle to determine how their noise complaints are resolved by DEP. Such complaints may be submitted via 311 or DEP’s website, and most complaints are submitted via 311.<sup>5, 6</sup> The 311 dataset on NYC’s Open Data Portal may provide a description of a complaint’s resolution; however, such descriptions are rarely comprehensive, and may be inaccessible to those without a high degree of technical literacy. DEP does not publish how it resolves complaints submitted via the DEP website. Although DEP must report annually on its noise inspection process pursuant to Local Law 53 of 2018,<sup>7</sup> the required report only includes high-level information and is unlikely to help a member of the public determine how DEP resolved a particular noise complaint.

*Noise Pollution from Motor Vehicles:*

In 2022, New Yorkers submitted 64,877 complaints to 311 about noise emanating from a vehicle.<sup>8</sup> Some of these complaints may be due to noise from a vehicle’s muffler or exhaust, while others are due to music played from a speaker inside the vehicle. Certain community boards, including Manhattan 12, Bronx 4, Bronx 5, and Queens 8, receive significantly more 311 complaints concerning vehicle noise than the citywide average. The number of vehicle noise complaints follows a seasonal pattern, with the number of complaints increasing during summer months. The annual number of vehicle noise complaints has declined from its peak in 2020, although the number of vehicle noise complaints received in 2022 was still above pre-pandemic levels.<sup>9</sup>

In February 2022, DEP announced a pilot noise camera program to detect vehicles with excessively loud mufflers and exhausts.<sup>10</sup> The program uses a device that takes a photograph of any vehicle that creates a noise in excess of 85 decibels from over 50 feet away. According to DEP, the photograph contains no identifying information about the vehicle or its driver except for the vehicle’s license plate.<sup>11</sup> On the basis of information gathered by the pilot program, DEP may cite a driver for violation of the noise code and instruct the driver to bring their vehicle to a DEP facility so that the Department may inspect for a prohibited, aftermarket muffler or exhaust system.<sup>12</sup> Citations issued pursuant to the pilot program result in civil penalties and do not add points to a driver’s record. The penalties for an excessively loud muffler or exhaust on a light-duty vehicle are: \$150–\$525 for a first offense; \$300–\$1,050 for a second offense; and \$450–\$1,575 for a third or subsequent offense.<sup>13</sup> In October 2023, DEP testified that it had installed seven noise cameras pursuant to the pilot and that the noise cameras “are paying for themselves” with the revenue generated from tickets.<sup>14, 15</sup>

<sup>4</sup> Adm. Code § 24-257

<sup>5</sup> “Noise Code,” *NYC Department of Environmental Protection*, <https://www.nyc.gov/site/dep/environment/noise-code.page>.

<sup>6</sup> “311 Service Requests from 2010 to Present,” *NYC Open Data Portal*, 9/6/2023, <https://data.cityofnewyork.us/stories/s/7ahn-yppf>.

<sup>7</sup> Local laws of the city of New York for the year 2018. No. 53.

<sup>8</sup> <https://legistar.council.nyc.gov/View.ashx?M=F&ID=7179102&GUID=BAD6A98D-CE92-4E6B-AAAF-D0C99DF36B5C>

<sup>9</sup> *Id.*

<sup>9</sup> “311 Service Requests from 2010 to Present,” *NYC Open Data Portal*, 9/6/2023, <https://data.cityofnewyork.us/stories/s/7ahn-yppf>.

<sup>10</sup> “Roadside Sound Meter Camera that is Activated by Loud Mufflers Now Sending Notices to Vehicle Owners,” *NYC Department of Environmental Protection*, 2/22/2022, <https://www.nyc.gov/site/dep/news/22-005/roadside-sound-meter-camera-is-activated-loud-mufflers-now-sending-notices-vehicle>.

<sup>11</sup> *Id.*

<sup>12</sup> *Id.*

<sup>13</sup> Adm. Code § 24-257

<sup>14</sup> “Transcript of the Minutes of the Committee on Environmental Protection, Resiliency and Waterfronts”, City Council City of New York, 10/16/2023, <https://legistar.council.nyc.gov/View.ashx?M=F&ID=12450558&GUID=5DC7F252-8C03-48A2-818B-603FECF45D60>, pg. 84

<sup>15</sup> *Id.*, pg. 113

*Citizen's Noise Complaint Program:*

The New York City Administrative Code allows citizens to file complaints against alleged violators of New York City's noise code.<sup>16</sup> Citizen complainants must first serve a complaint upon DEP.<sup>17</sup> If, within 30 days of serving the complaint on DEP, DEP has failed to serve a notice of complaint upon the person allegedly responsible for the violation or has failed to serve a written notice upon the complainant that their complaint is frivolous or duplicitous, then the complainant may serve a notice of violation directly upon the person allegedly responsible and on the Environmental Control Board ("ECB").<sup>18</sup> Summonses that result from notices served upon ECB are adjudicated by OATH, which has final say over its hearing decisions unless an appeal is filed and accepted.<sup>19</sup> Citizen enforcers may collect 50% of any penalty assessed by OATH as compensation for any proceeding they successfully prosecute, and up to 25% of any penalty for any proceeding DEP prosecutes as a result of a complaint they filed.<sup>20</sup> Violators are subject to a schedule of fines that increase upon a violator's second and third violation.<sup>21</sup> The ECB may remit, in whole or in part, the penalty imposed, if it determines that the violator is no longer in violation of the noise code at the time of the hearing.<sup>22</sup> Citizen complaints served upon DEP, ECB, or the person alleged responsible for a violation of the noise code are distinct from noise complaints submitted to 311.

Virtually all citizen noise complaints allege violations of Admin. Code § 24-244(b)(i), which prohibits the use of any sound reproduction device "for commercial or business advertising purposes or for the purpose of attracting attention to any performance, show, sale or display of merchandise, in connection with any commercial or business enterprise . . . outside or in front of any building, place or premises," *inter alia*. Citizens have served noise complaints that allege violation of § 24-244(b)(i) to commercial establishments for noise that does not explicitly serve an advertising purpose, such as music that originates from a restaurant. The DEP Commissioner has decried these serial complaints as "not legitimate enforcement activity," and called for changes to the law.<sup>23</sup> According to DEP, just two citizens were responsible for 90% of the 6,000 citizen noise complaints submitted between January and October 2023.<sup>24</sup> Some civilian complainants have countered that they are only responding to DEP's unwillingness to enforce its own laws.<sup>25</sup>

On June 23, 2023, NBC New York published an article about the citizen's noise complaint program, in which some local businesses reported a deluge of summonses alleging noise code violations, often complaining that they received multiple summonses at one time, without the opportunity to cure any defects.<sup>26</sup> According to a representative of the NYC Hospitality Alliance, some businesses received up to six violation notices filed by the same individual, by the time they were notified of the initial violation.<sup>27</sup> An employee of a Midtown Manhattan restaurant stated that the establishment was facing at minimum \$8,000 in fines, and potentially up to \$33,000 in fines.<sup>28</sup> The owner of a restaurant in the Hell's Kitchen neighborhood in Manhattan stated that the business was facing over \$33,000 in fines stemming from seven individual complaints that had all been filed by the same individual.<sup>29</sup>

Concerns have also been raised about whether relying on a citizen-based enforcement model may be leading to inequitable outcomes due to uneven scrutiny on the part of participating complainants.<sup>30</sup> Analysis of city

<sup>16</sup> Adm. Code § 24-261(a).

<sup>17</sup> Adm. Code § 24-261(b).

<sup>18</sup> *Id.*

<sup>19</sup> "About ECB," *Office of Administrative Trials and Hearings*, <https://www.nyc.gov/site/oath/hearings/about-ecb.page>.

<sup>20</sup> Adm. Code § 24-261(d)-(e).

<sup>21</sup> Adm. Code § 24-257, Table I.

<sup>22</sup> Adm. Code § 24-257(b)(5).

<sup>23</sup> Chris Glorioso, "I-Team: Thousands of citizen-issued noise violations prompt NYC reform," NBC New York, 6/29/2023, <https://www.nbcnewyork.com/news/local/i-team-thousands-of-citizen-issued-noise-violations-prompt-nyc-reform/4462207/>.

<sup>24</sup> *Id.*

<sup>25</sup> Chris Glorioso, Eduardo González Quintero, "I-Team: How one NYC resident makes a living writing thousands of noise tickets," NBC New York, 6/23/2023, <https://www.nbcnewyork.com/news/local/i-team-how-one-nyc-resident-makes-a-living-writing-thousands-of-noise-tickets/4448563/>.

<sup>26</sup> *Id.*

<sup>27</sup> *Id.*

<sup>28</sup> *Id.*

<sup>29</sup> Lisa Fickensher, "NYC Residents make money off noise complaints targeting bars, restaurants," New York Post, 7/4/2023, <https://nypost.com/2023/07/04/nyc-residents-make-money-off-noise-complaints-targeting-bars-restaurants/>.

<sup>30</sup> Chris Glorioso, Eduardo González Quintero, "I-Team: How one NYC resident makes a living writing thousands of noise tickets"

administrative court records by the NBC News I-Team showed that one prolific participant in the citizen noise enforcement program had filed over 300 complaints in Corona and Jackson Heights, in the borough of Queens, issuing more summonses in these predominantly immigrant communities than they had in all other New York City zip codes combined.<sup>31</sup> Of the 2,537 hearings concerning alleged violations of Admin. Code § 24-244(b) that OATH adjudicated in 2022, 424 involved businesses located on Roosevelt Avenue, a thoroughfare in Queens.<sup>32</sup>

### **III. LEGISLATION**

#### **Proposed Int. No. 774-A**

This bill would require DEP, upon the request of an owner, lessor or occupant of a dwelling unit within a building located within a half-mile radius of a construction site, to conduct an inspection pursuant to section 24-223, 24-228, or 24-229, which respectively concern noise from after-hours construction, construction devices, and the handling or transport of containers and construction material. When conducting such an inspection, DEP would be required to measure the sound level with closed windows and doors. Additionally, the bill would expand the definition of unreasonable noise from construction devices in section 24-228 to include sound attributable to a construction device that is 10 A-weighted decibels above the ambient noise level, on or after 7:00 a.m. and before 10:00 p.m., as measured from within a residential property dwelling.

This bill would take effect 120 days after it becomes law.

#### **Proposed Int. No. 775-A**

This bill would mandate that DEP publish the results of its noise inspections online within 5 business days after they have been completed. This is a change from the bill as heard, which would have required DEP to publish the results of noise inspections online within 24 hours after they have been completed.

This bill would take effect immediately after it becomes law.

#### **Proposed Int. No. 776-A**

This bill would require DEP and the police department to give a copy of the noise inspection report created after a 311 noise complaint to anyone who requests the report and provides the 311 tracking number within 14 days of receiving such a request. DEP and the police department may determine the form and manner in which such requests shall be submitted. The person requesting the noise inspection report would not have to submit a Freedom of Information Law request to receive the report.

This bill would take effect 120 days after it becomes law.

#### **Proposed Int. No. 778-A**

This bill would establish a noise camera program that would detect motor vehicles exceeding the noise limits under city law. Any vehicle found to be violating such limits would be issued a notice of violation and subject to the civil penalty as prescribed by the existing law. Further, when certain elected officials request the installation of a noise camera at a particular location, DEP would be required to respond with a determination as to whether the location requested is appropriate for inclusion in the photo noise camera program within 30 days. DEP would also be required to submit to the Mayor and the Speaker of the Council, and to post on its website, an annual report on the program, including the locations of the noise cameras, the number of violations detected, and any expenses incurred in connection with the program. The first of these reports would be required to be

---

<sup>31</sup> *Id.*

<sup>32</sup> "OATH Hearing Division Case Status," *NYC Open Data Portal*, 9/13/2023, <https://data.cityofnewyork.us/City-Government/OATH-Hearings-Division-Case-Status/jz4z-kudi>.

published no later than January 31, 2025. Additionally, the bill would require DEP to ensure that there are no less than five noise cameras in each borough by September 30, 2025, subject to appropriation.

This bill would take effect 60 days after it becomes law.

### **Proposed Int. No. 1194-A**

This bill would cap the compensation citizen complainants can receive when their complaint prompts proceedings under subdivision (b) of section 24-244 of the noise code. Compensation for proceedings brought by DEP would be capped at \$5, and compensation for proceedings brought by a complainant would be capped at \$10.

Section two of Proposed Int. No. 194-A adds an unconsolidated section of law that would limit the amount of the civil penalty that may be imposed for a violation of subdivision (b) of section 24-244 in any proceeding that was brought pursuant to section 24-261 and commenced prior to the effective date of Proposed Int. No. 1194-A. For citizen complaint proceedings commenced prior to the effective date of the bill for which a resolution has not yet been reached prior to such date, the maximum penalty for a violation of subdivision (b) of section 24-244 would be capped at \$50. This provision is intended to balance the goal of providing immediate relief to businesses that have been subject to civil penalties as a result of the enforcement proceedings authorized by section 24-261 with the goal of recognizing the time and effort expended by the persons who have commenced such proceedings.

This bill would take effect immediately after it becomes law.

**(The following is the text of the Fiscal Impact Statement for Int. No. 774-A:)**

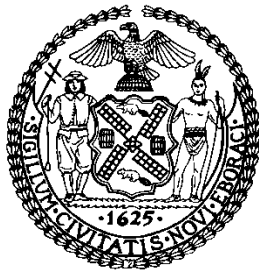

**THE COUNCIL OF THE CITY OF NEW YORK  
FINANCE DIVISION**

**TANISHA EDWARDS, CHIEF FINANCIAL OFFICER AND  
DEPUTY CHIEF OF STAFF TO THE SPEAKER**

**RICHARD LEE, DIRECTOR**

**FISCAL IMPACT STATEMENT**

**PROPOSED INT. NO. 774-A**

**COMMITTEE:** Environmental Protection, Resiliency and Waterfronts

**TITLE:** A Local Law to amend the administrative code of the city of New York, in relation to requiring the department of environmental protection to measure construction-related sound levels inside dwelling units upon request and prohibited noise levels for sound attributable to construction devices on or after 7:00 a.m. and before 10 p.m.

**Sponsors:** Council Members Powers, Mealy, Restler, Menin, Yeger, Joseph, Holden, Schulman, Brewer, Hudson, Bottcher, Hanks, Riley, Abreu, Marte, Lee, Brannan, Rivera, Cabán, Hanif and Gennaro.



**SUMMARY OF LEGISLATION:** This bill would require the Department of Environmental Protection (DEP), upon the request of an owner, lessor or occupant of a dwelling unit within a building located within a half-mile radius of a construction site, to measure sound levels within such units with closed windows and doors.

**EFFECTIVE DATE:** This bill would take effect 120 days after it becomes law

**FISCAL YEAR (FY) IN WHICH FULL FISCAL IMPACT ANTICIPATED: FY25**

---

**FISCAL IMPACT STATEMENT:**

	<b>Effective FY24</b>	<b>Succeeding FY25</b>	<b>Full Fiscal Impact FY25</b>
<b>Revenues (+)</b>	\$0	\$0	\$0
<b>Expenditures (-)</b>	\$0	\$0	\$0
<b>Net</b>	\$0	\$0	\$0

**IMPACT ON REVENUES:** It is estimated that there would be no impact on revenues resulting from the enactment of this legislation as full compliance with the law is anticipated.

**IMPACT ON EXPENDITURES:** It is estimated that there would be no fiscal impact on expenditures resulting from the enactment of this legislation as the agencies responsible for carrying out its requirements would use existing resources to fulfill its requirements.

**SOURCE OF FUNDS TO COVER ESTIMATED COSTS:** N/A

**SOURCE OF INFORMATION:** New York City Council Finance Division

**ESTIMATE PREPARED BY:** Tanveer Singh, Legislative Financial Analyst

**ESTIMATE REVIEWED BY:** Aliya Ali , Unit Head  
Chima Obichere, Deputy Director  
Kathleen Ahn, Finance Division Counsel  
Jonathan Rosenberg, Managing Deputy Director

**LEGISLATIVE HISTORY:** This legislation was introduced to the Council on October 12, 2022, as Intro. No. 774 and referred to the Committee on Environmental Protection, Resiliency and Waterfronts (the Committee). The legislation was then re-referred to the Committee on March 7, 2023. The legislation was considered by the Committee at a hearing held on October 16, 2023, and laid over. The legislation has been amended, and the amended version, Proposed Intro. No. 774-A will be considered by the Committee on December 6, 2023. Upon successful vote by the Committee, Proposed Intro. No. 774-A will be submitted to the full Council for a vote on December 6, 2023.

**DATE PREPARED:** 12/05/2023.

(For text of Int. Nos. 775-A 776-A, 778-A, and 1194-A and their Fiscal Impact Statements, please see the Report of the Committee on for Environmental Protection, Resiliency and Waterfronts for Int. Nos. 775-A, 776-A, 778-A, and 1194-A, respectively, printed in these Minutes; for text of Int. No. 774-A, please see below)

Accordingly, this Committee recommends the adoption of Int. No. 774-A, 775-A, 776-A, 778-A, and 1194-A.

**(The following is the text of Int. No. 774-A:)**

## Int. No. 774-A

By Council Members Powers, Mealy, Restler, Menin, Yeger, Joseph, Holden, Schulman, Brewer, Hudson, Bottcher, Hanks, Riley, Abreu, Marte, Lee, Brannan, Rivera, Cabán, Hanif, Gennaro, Dinowitz and Narcisse.

**A Local Law to amend the administrative code of the city of New York, in relation to requiring the department of environmental protection to measure construction-related sound levels inside dwelling units upon request and prohibited noise levels for sound attributable to construction devices on or after 7:00 a.m. and before 10 p.m.**

*Be it enacted by the Council as follows:*

Section 1. Subdivision 11 of section 24-203 of the administrative code of the city of New York, as amended by local law number 113 for the year 2005, is amended to read as follows:

(11) Building means a building as defined in section [27-232 of the administrative code] 28-101.5.

§ 2. Subchapter 4 of chapter 2 of title 24 of the administrative code of the city of New York is amended by adding a new section 24-224.1 to read as follows:

*§ 24-224.1 Measuring sound levels in dwelling units upon request. When conducting an inspection pursuant to section 24-223, 24-228, or 24-229, upon the request of an owner, lessor or occupant of a residential receiving property dwelling unit within a building located within a half-mile radius of a construction site, the department shall measure the sound level at any point within such dwelling unit with windows and doors that may affect the measurement closed.*

§ 3. Subdivision (a) of section 24-228 of the administrative code of the city of New York is amended by adding a new paragraph (4) to read as follows:

*(4) Sound attributable to the source that is 10 dB(A) above the ambient sound level, on or after 7:00 a.m. and before 10:00 p.m., as measured in any residential receiving property dwelling unit with windows and doors that may affect the measurement closed.*

§ 4. This local law takes effect 120 days after it becomes law.

JAMES F. GENNARO, *Chairperson*; JENNIFER GUTIÉRREZ, KAMILLAH HANKS, ROBERT F. HOLDEN, JULIE MENIN, SANDY NURSE, LINCOLN RESTLER; 7-0-0; Committee on Environmental Protection, Resiliency & Waterfronts, December 6, 2023.

On motion of the Speaker (Council Member Adams), and adopted, the foregoing matter was coupled as a General Order for the day (see ROLL CALL ON GENERAL ORDERS FOR THE DAY).

Report for Int. No. 775-A

**Report of the Committee on Environmental Protection, Resiliency and Waterfronts in favor of approving and adopting, as amended, a Local Law to amend the administrative code of the city of New York, in relation to results of noise inspections.**

The Committee on Environmental Protection, Resiliency and Waterfronts, to which the annexed proposed amended local law was referred on October 12, 2022 (Minutes, page 2476), respectfully

**REPORTS:**

(For text of report, please see the Report of the Committee on Environmental Protection, Resiliency and Waterfronts for Int. No. 774-A printed above in these Minutes)

*The following is the text of the Fiscal Impact Statement for Int. No. 775-A:*

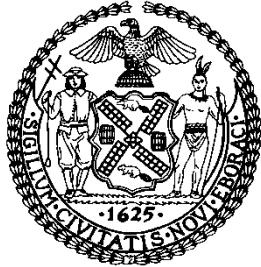

**THE COUNCIL OF THE CITY OF NEW YORK  
FINANCE DIVISION**

**TANISHA EDWARDS, CHIEF FINANCIAL OFFICER  
AND DEPUTY CHIEF OF STAFF TO THE SPEAKER**

**RICHARD LEE, DIRECTOR**

**FISCAL IMPACT STATEMENT**

**PROPOSED INT. NO. 775-A**

**COMMITTEE:** Environmental Protection, Resiliency and Waterfronts

**TITLE:** A Local Law to amend the administrative code of the city of New York, in relation to results of noise inspections

**Sponsors:** Council Members Powers, Restler, Menin, Yeger, Joseph, Holden, Schulman, Brewer, Hudson, Bottcher, Hanks, Riley, Abreu, Louis, Marte, Lee, Brannan, Rivera, Cabán, Hanif and Gennaro.

**SUMMARY OF LEGISLATION:** This bill would mandate that the Department of Environmental Protection publish the results of their noise inspections online within 5 business days after they have been completed.

**EFFECTIVE DATE:** This bill would take effect immediately.

**FISCAL YEAR (FY) IN WHICH FULL FISCAL IMPACT ANTICIPATED:** FY25

**FISCAL IMPACT STATEMENT:**

	<b>Effective FY24</b>	<b>Succeeding FY25</b>	<b>Full Fiscal Impact FY25</b>
<b>Revenues (+)</b>	\$0	\$0	\$0
<b>Expenditures (-)</b>	\$0	\$0	\$0
<b>Net</b>	\$0	\$0	\$0

**IMPACT ON REVENUES:** It is estimated that there would be no impact on revenues resulting from the enactment of this legislation.

**IMPACT ON EXPENDITURES:** It is estimated that there would be no fiscal impact on expenditures resulting from the enactment of this legislation as the agency responsible for carrying out its requirements would use existing resources to fulfill its requirements.

**SOURCE OF FUNDS TO COVER ESTIMATED COSTS:** N/A

**SOURCE OF INFORMATION:** New York City Council Finance Division  
Mayor's Office of City Legislative Affairs

**ESTIMATE PREPARED BY:** Tanveer Singh, Legislative Financial Analyst

**ESTIMATE REVIEWED BY:** Aliya Ali, Unit Head  
Chima Obichere, Deputy Director  
Kathleen Ahn, Finance Division Counsel  
Jonathan Rosenberg, Managing Deputy Director

**LEGISLATIVE HISTORY:** This legislation was introduced to the Council on October 12, 2022, as Intro. No. 775 and referred to the Committee on Environmental Protection, Resiliency and Waterfronts (the Committee). The legislation was then re-referred to the Committee on March 7, 2023. The legislation was considered by the Committee at a hearing held on October 16, 2023, and laid over. The legislation has been amended, and the amended version, Proposed Intro. No. 775-A will be considered by the Committee on December 6, 2023. Upon successful vote by the Committee, Proposed Intro. No. 775-A will be submitted to the full Council for a vote on December 6, 2023.

**DATE PREPARED:** 12/05/2023.

*Accordingly, this Committee recommends its adoption, as amended.*

**(The following is the text of Int. No. 775-A:)**

Int. No. 775-A

By Council Members Powers, Restler, Menin, Yeger, Joseph, Holden, Schulman, Brewer, Hudson, Bottcher, Hanks, Riley, Abreu, Louis, Marte, Lee, Brannan, Rivera, Cabán, Hanif, Gennaro, Dinowitz and Narcisse.

**A Local Law to amend the administrative code of the city of New York, in relation to results of noise inspections**

*Be it enacted by the Council as follows:*

Section 1. Subdivisions (f) of section 24-207 of the administrative code of the city of New York, as added by local law number 53 for the year 2018, are amended to read as follows:

(f) The commissioner shall publish on the city's website;

(i) the manner by which noise levels shall be measured during [inspections] *an inspection* conducted pursuant to this section and in accordance with section 24-217.1 [which shall be available online]; *and*

(ii) *the results of each such inspection, which shall be made available on the city's website within 5 business days after such inspection has been completed.*

[(f)] (g) By no later than January 31 of each year, the department shall submit to the mayor and the council, and publicly post on [its] *the city's* website, a report, containing, at a minimum, for the previous calendar year:

(i) the number of inspectors employed by the department;

(ii) the number of complaints regarding noise received by the department, disaggregated by the type of noise;

(iii) the number of after hours noise complaints responded to within the amount of time prescribed by rule as well as the number of duplicative after hours noise complaints;

(iv) the number of non-violation resolutions to complaints;

(v) the number of noise related violations issued;

(vi) the number of such violations which were dismissed;

(vii) the amount of civil penalties which were paid pursuant to such violations;

- (viii) the number of alternative noise mitigation plans approved pursuant to section 24-221 [of this code];  
and  
(ix) the number of written stop work orders issued pursuant to section 24-223.1 [of this code].  
§ 2. This local law takes effect immediately.

JAMES F. GENNARO, *Chairperson*; JENNIFER GUTIÉRREZ, KAMILLAH HANKS, ROBERT F. HOLDEN, JULIE MENIN, SANDY NURSE, LINCOLN RESTLER; 7-0-0; Committee on Environmental Protection, Resiliency & Waterfronts, December 6, 2023.

On motion of the Speaker (Council Member Adams), and adopted, the foregoing matter was coupled as a General Order for the day (see ROLL CALL ON GENERAL ORDERS FOR THE DAY).

Report for Int. No. 776-A

**Report of the Committee on Environmental Protection, Resiliency and Waterfronts in favor of approving and adopting, as amended, a Local Law to amend the administrative code of the city of New York, in relation to providing noise inspection reports.**

The Committee on Environmental Protection, Resiliency and Waterfronts, to which the annexed proposed amended local law was referred on October 12, 2022 (Minutes, page 2476), respectfully

**REPORTS:**

**(For text of report, please see the Report of the Committee on Environmental Protection, Resiliency and Waterfronts for Int. No. 774-A printed above in these Minutes)**

*The following is the text of the Fiscal Impact Statement for Int. No. 776-A:*

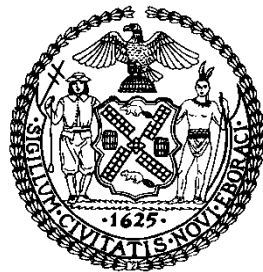

**THE COUNCIL OF THE CITY OF NEW YORK**

**FINANCE DIVISION**

**TANISHA EDWARDS, CHIEF FINANCIAL OFFICER  
AND DEPUTY CHIEF OF STAFF TO THE SPEAKER**

**RICHARD LEE, DIRECTOR**

**FISCAL IMPACT STATEMENT**

**PROPOSED INT. NO. 776-A**

**COMMITTEE: Environmental Protection, Resiliency  
and Waterfronts**

**TITLE:** A Local Law to amend the administrative code of the city of New York, in relation to providing noise inspection reports.

**Sponsors:** Council Members: Members Powers, Restler, Menin, Yeger, Joseph, Holden, Schulman, Brewer, Hudson, Bottcher, Hanks, Riley, Abreu, Marte, Lee, Brannan, Rivera, Cabán, Hanif and Gennaro.

**SUMMARY OF LEGISLATION:** This bill would require the Department of Environmental Protection and the Police Department to give a copy of the noise inspection report created after a 311 noise complaint to anyone who requests the report and provides the 311 tracking number. The person requesting the noise inspection report would not have to submit a Freedom of Information Law request to receive the report.

**EFFECTIVE DATE:** This bill would take effect 120 days after it becomes law.

**FISCAL YEAR (FY) IN WHICH FULL FISCAL IMPACT ANTICIPATED: FY25**

**FISCAL IMPACT STATEMENT:**

	<b>Effective FY24</b>	<b>Succeeding FY25</b>	<b>Full Fiscal Impact FY25</b>
<b>Revenues (+)</b>	\$0	\$0	\$0
<b>Expenditures (-)</b>	\$0	\$0	\$0
<b>Net</b>	\$0	\$0	\$0

**IMPACT ON REVENUES:** It is estimated that there would be no impact on revenues resulting from the enactment of this legislation.

**IMPACT ON EXPENDITURES:** It is estimated that there would be no fiscal impact on expenditures resulting from the enactment of this legislation as the agencies responsible for carrying out its requirements would use existing resources to fulfill its requirements.

**SOURCE OF FUNDS TO COVER ESTIMATED COSTS:** N/A

**SOURCE OF INFORMATION:** New York City Council Finance Division  
Mayor’s Office of City Legislative Affairs

**ESTIMATE PREPARED BY:** Tanveer Singh, Legislative Financial Analyst

**ESTIMATE REVIEWED BY:** Aliya Ali, Unit Head  
Chima Obichere, Deputy Director  
Kathleen Ahn, Finance Division Counsel  
Jonathan Rosenberg, Managing Deputy Director

**LEGISLATIVE HISTORY:** This legislation was introduced to the Council on October 12, 2022, as Intro. No. 776 and referred to the Committee on Environmental Protection, Resiliency and Waterfronts (the Committee). The legislation was then re-referred to the Committee on March 7, 2023. The legislation was considered by the Committee at a hearing held on October 16, 2023, and laid over. The legislation has been amended, and the amended version, Proposed Intro. No. 776-A will be considered by the Committee on December 6, 2023. Upon successful vote by the Committee, Proposed Intro. No. 776-A will be submitted to the full Council for a vote on December 6, 2023.

**DATE PREPARED:** 12/05/2023.

*Accordingly, this Committee recommends its adoption, as amended.*

**(The following is the text of Int. No. 776-A:)**

## Int. No. 776-A

By Council Members Powers, Restler, Menin, Yeger, Joseph, Holden, Schulman, Brewer, Hudson, Bottcher, Hanks, Riley, Abreu, Marte, Lee, Brannan, Rivera, Cabán, Hanif, Gennaro, Dinowitz and Narcisse.

**A Local Law to amend the administrative code of the city of New York, in relation to providing noise inspection reports**

*Be it enacted by the Council as follows:*

Section 1. Subchapter 2 of chapter 2 of title 24 of the administrative code of the city of New York is amended by adding a new section 24-217.2 to read as follows:

§ 24-217.2 *Noise inspection reports. a. Where the department generates a noise inspection report pursuant to a complaint submitted through 311, any person may request a copy of such report by providing the 311 tracking number on a form and in a manner to be specified by the department subject to subdivision d of this section.*

*b. Where the police department generates a noise inspection report pursuant to a complaint submitted through 311, any person may request a copy of such report by providing the 311 tracking number to the police department on a form and in a manner to be specified by such department subject to subdivision d of this section.*

*c. The department or police department shall provide a copy of a report requested under this section within 14 days of receiving such a request.*

*d. The department or police department shall not deny or decline to act on a request made pursuant to this section on the ground that such request fails to constitute a request made pursuant to section 87 of the public officers law.*

§ 2. This local law takes effect 120 days after it becomes law.

JAMES F. GENNARO, *Chairperson*; JENNIFER GUTIÉRREZ, KAMILLAH HANKS, ROBERT F. HOLDEN, JULIE MENIN, SANDY NURSE, LINCOLN RESTLER; 7-0-0; Committee on Environmental Protection, Resiliency & Waterfronts, December 6, 2023.

On motion of the Speaker (Council Member Adams), and adopted, the foregoing matter was coupled as a General Order for the day (see ROLL CALL ON GENERAL ORDERS FOR THE DAY).

Report for Int. No. 778-A

**Report of the Committee on Environmental Protection, Resiliency and Waterfronts in favor of approving and adopting, as amended, a Local Law to amend the administrative code of the city of New York, in relation to establishing a photo noise violation monitoring device program for motor vehicles.**

The Committee on Environmental Protection, Resiliency and Waterfronts, to which the annexed proposed amended local law was referred on October 12, 2022 (Minutes, page 2477), respectfully

**REPORTS:**

**(For text of report, please see the Report of the Committee on Environmental Protection, Resiliency and Waterfronts for Int. No. 774-A printed above in these Minutes)**

*The following is the text of the Fiscal Impact Statement for Int. No. 778-A:*

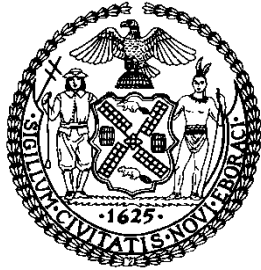

**THE COUNCIL OF THE CITY OF NEW YORK  
FINANCE DIVISION**

**TANISHA EDWARDS, CHIEF FINANCIAL OFFICER  
AND DEPUTY CHIEF OF STAFF TO THE SPEAKER**

**RICHARD LEE, DIRECTOR**

**FISCAL IMPACT STATEMENT**

**PROPOSED INT. NO. 778-A**

**COMMITTEE:** Environmental Protection, Resiliency and Waterfronts

**TITLE:** A Local Law to amend the administrative code of the city of New York, in relation to establishing a photo noise violation monitoring device program for motor vehicles.

**Sponsors:** Council Members Powers, Yeger, Holden, Restler, Menin, Joseph, Schulman, Brewer, Hudson, Bottcher, Hanks, Abreu, Ung, Dinowitz, Louis, Marte, Lee, Rivera, Hanif, Gennaro and Vernikov.

**SUMMARY OF LEGISLATION:** This bill would establish a noise camera program that would detect motor vehicles exceeding the noise limits under city law. Any vehicle found to be violating such limits would be issued a notice of violation and subject to the civil penalty as prescribed by the existing law. Subject to appropriation, the Department of Environmental Protection (DEP) would be required to ensure that there are no less than 5 noise cameras in each borough. DEP would also be required to submit to the Mayor and the Speaker of the Council, and to post on its website, an annual report on the program including the locations of the noise cameras, the number of violations detected, and any expenses incurred in connection with the program.

**EFFECTIVE DATE:** This bill would take effect 60 days after it becomes law.

**FISCAL YEAR (FY) IN WHICH FULL FISCAL IMPACT ANTICIPATED:** FY25

**FISCAL IMPACT STATEMENT:**

	<b>Effective FY24</b>	<b>Succeeding FY25</b>	<b>Full Fiscal Impact FY25</b>
<b>Revenues (+)</b>	\$0	\$0	\$0
<b>Expenditures (-)</b>	(See Below)	(See Below)	(See Below)
<b>Net</b>	(See Below)	(See Below)	(See Below)

**IMPACT ON REVENUES:** It is estimated that there would be no impact on revenues resulting from the enactment of this legislation as full compliance with the law is anticipated.

**IMPACT ON EXPENDITURES:** According to previous testimony by the Department of Environmental Protection, the projected cost of one roadside sound meter is \$35,000. Subject to appropriation, this legislation calls for no less than five roadside sound meters to be installed within each of the five boroughs (Brooklyn,



Manhattan, Queens, Bronx and Staten Island) by Fiscal Year 2025. Currently within New York City there are twelve roadside sound meters being rotated in various locations. Given these cameras are moveable, the potential capital costs would be \$455,000 for the cost of installing an additional thirteen roadside sound meters.

**SOURCE OF FUNDS TO COVER ESTIMATED COSTS:** General Fund

**SOURCE OF INFORMATION:** New York City Council Finance Division

**ESTIMATE PREPARED BY:** Tanveer Singh, Legislative Financial Analyst

**ESTIMATE REVIEWED BY:** Aliya Ali, Unit Head  
Chima Obichere, Deputy Director  
Kathleen Ahn, Finance Division Counsel  
Jonathan Rosenberg, Managing Deputy Director

**LEGISLATIVE HISTORY:** This legislation was introduced to the Council on October 12, 2022, as Intro. No. 778 and referred to the Committee on Environmental Protection, Resiliency and Waterfronts (the Committee). This legislation was re-referred to the Committee on March 3, 2023. The legislation was considered by the Committee at a hearing held on October 16, 2023, and laid over. The legislation was subsequently amended, and the amended version, Proposed Intro. No. 778-A will be considered by the Committee on December 6, 2023. Upon successful vote by the Committee, Proposed Intro. No. 778-A will be submitted to the full Council for a vote on December 6, 2023.

**DATE PREPARED:** 12/05/2023.

*Accordingly, this Committee recommends its adoption, as amended.*

**(The following is the text of Int. No. 778-A:)**

Int. No. 778-A

By Council Members Powers, Yeger, Holden, Restler, Menin, Joseph, Schulman, Brewer, Hudson, Bottcher, Hanks, Abreu, Ung, Dinowitz, Louis, Marte, Lee, Rivera, Hanif, Gennaro, Narcisse and Vernikov.

**A Local Law to amend the administrative code of the city of New York, in relation to establishing a photo noise violation monitoring device program for motor vehicles**

*Be it enacted by the Council as follows:*

Section 1. Subchapter 6 of chapter 2 of title 24 of the administrative code of the city of New York is amended by adding a new section 24-236.1 to read as follows:

§ 24-236.1 *Owner liability for failure to comply with motor vehicle sound limits. a. Definitions. For the purposes of this section, the following terms have the following meanings:*

*Owner. The term "owner" has the meaning provided in section 239 of the vehicle and traffic law.*

*Photo noise violation monitoring device. The term "photo noise violation monitoring device" means 1 or more mobile or fixed vehicle sensors installed to work in conjunction with 1 or more noise measuring apparatuses, such as a decibel reader, which automatically produces 2 or more photographs, 2 or more microphotographs, a videotape, or other recorded images of each motor vehicle at the time it is used or operated in violation of the motor vehicle noise limits prescribed in section 24-236.*

*b. Photo noise violation monitoring device program established. 1. The department, in consultation with the police department and the department of transportation, shall establish a program of photo noise violation*

monitoring devices to monitor compliance with the limitations on sound set forth in section 24-236. Any motor vehicle found to be violating such provisions shall be issued a notice of violation and shall be subject to the civil penalty prescribed in table I of paragraph (5) of subdivision (b) of section 24-257.

2. No photo noise violation monitoring device shall be used unless it has undergone an annual calibration check performed pursuant to paragraph 3 of this subdivision.

3. Each photo noise violation monitoring device shall undergo an annual calibration check by the manufacturer of such device or by the department. Such manufacturer or the department shall provide a certification of such calibration. The department shall maintain each such certificate of calibration for each photo noise violation monitoring device in operation until the final resolution of all cases involving a notice of violation issued during such year that utilized photographs, microphotographs, videotape, or other recorded images produced by such device.

4. It shall be a defense to any prosecution for a violation issued pursuant to this section that the photo noise violation monitoring device that produced the photographs, microphotographs, videotape, or other recorded images was malfunctioning at the time of the alleged violation.

5. The department shall utilize necessary technologies to ensure, to the extent practicable, that photographs, microphotographs, videotape, or other recorded images produced by the photo noise violation monitoring devices do not include images that identify the driver, the passengers, or the contents of the motor vehicle, provided, however, that where the department shows that it made reasonable efforts to comply with the provisions of this paragraph a notice of violation issued pursuant to this section shall not be dismissed solely because the photograph, microphotograph, videotape, or other recorded image allows for the identification of the driver, the passengers, or the contents of motor vehicles.

6. Any photograph, microphotograph, videotape, or other recorded image from a photo noise violation monitoring device shall be for the exclusive use of the city for the purpose of the adjudication of liability imposed pursuant to subchapter 8 of this chapter and for the motor vehicle owner receiving a notice of violation. Notwithstanding the provisions of any other law, rule, or regulation to the contrary, a photograph, microphotograph, videotape, or other recorded image from a photo noise violation monitoring device shall not be available to the public, nor subject to civil or criminal process or discovery, nor used by any court or administrative or adjudicatory body in any action or proceeding therein except that which is necessary for the adjudication of a notice of violation of section 24-236, and no public entity or employee, officer, or agent thereof shall disclose such information, except that a photograph, microphotograph, videotape, or other recorded image from such devices:

(a) Shall be available for inspection, copying, and use by the motor vehicle owner for so long as such photograph, microphotograph, videotape, or other recorded image is required to be maintained or is maintained by such public entity, employee, officer, or agent;

(b) Shall be furnished for use in a criminal action or proceeding when described in a search warrant issued by a court authorized to issue such a search warrant pursuant to article 690 of the criminal procedure law or a federal court authorized to issue such a search warrant under federal law, where such search warrant states that there is reasonable cause to believe such information constitutes evidence of, or tends to demonstrate that, a misdemeanor or felony offense was committed in this state or another state, or that a particular person participated in the commission of a misdemeanor or felony offense in this state or another state; and

(c) Shall be furnished for use in a criminal action or proceeding in response to a subpoena duces tecum signed by a judge of competent jurisdiction and issued pursuant to article 610 of the criminal procedure law or a judge or magistrate of a federal court authorized to issue such a subpoena duces tecum under federal law, where the judge finds and the subpoena states that there is reasonable cause to believe such information is relevant and material to the prosecution, or the defense, or the investigation by an authorized law enforcement official, of the alleged commission of a misdemeanor or felony in this state or another state.

7. Any photographs, microphotographs, videotapes, or other recorded images evidences of a violation shall include at least 1 date and time stamped image showing the license plate number of the vehicle and shall be available for inspection reasonably in advance of and during any hearing to adjudicate the liability for such violation pursuant to subchapter 8 of this chapter.

c. Placement of devices. To the extent practicable, the department shall select the locations for each photo noise violation monitoring device based on motor vehicle noise complaint data reported by the 311 customer service center and shall consider requests for placement of such devices made by persons including but not

limited to, the mayor, comptroller, public advocate, borough presidents, council members, and community boards. Subject to appropriations, the department shall ensure that there are no less than 5 photo noise monitoring devices in each borough by and after September 30, 2025. Upon receipt of a request by the mayor, comptroller, public advocate, a borough president, a council member, or a community board for installation of a photo noise violation monitoring device at a particular location, the department shall assess the request and respond within 30 days with a determination as to whether the location requested is appropriate for inclusion in the program.

d. *Multiple technologies.* The department may deploy multiple sound detection technologies within the photo noise violation monitoring devices as part of this program, including but not limited to:

1. Acoustic monitoring;
2. Beamforming devices; and
3. Artificial intelligence.

e. *Reporting.* No later than January 31, 2025, and on January 31 thereafter in each succeeding year in which the program is in operation, the commissioner shall submit to the mayor and the speaker of the council, and post on the department's website, a report on the use of photo noise violation monitoring devices for the previous calendar year. Such report shall include:

1. The locations of any such photo noise violation monitoring devices and time periods during which such devices were used;
  2. The total number of violations recorded by photo noise violation monitoring devices on a daily, weekly, and monthly basis;
  3. The total number of notices of violation issued for violations recorded by such devices;
  4. The total number of violations adjudicated in accordance with subchapter 8 of this chapter and the results of such adjudications, disaggregated by dispositions made for violations recorded by such devices; and
  5. Any expenses incurred by the city in connection with the program.
- § 2. This local law takes effect 60 days after it becomes law.

JAMES F. GENNARO, *Chairperson*; JENNIFER GUTIÉRREZ, KAMILLAH HANKS, ROBERT F. HOLDEN, JULIE MENIN, SANDY NURSE, LINCOLN RESTLER; 7-0-0; Committee on Environmental Protection, Resiliency & Waterfronts, December 6, 2023.

On motion of the Speaker (Council Member Adams), and adopted, the foregoing matter was coupled as a General Order for the day (see ROLL CALL ON GENERAL ORDERS FOR THE DAY).

Report for Int. No. 1194-A

**Report of the Committee on Environmental Protection, Resiliency and Waterfronts. in favor of approving and adopting, as amended, a local law to amend the administrative code of the city of New York, in relation to compensation awarded by the environmental control board to complainants for citizen noise complaints and to the maximum penalty authorized for violations of subdivision (b) of section 24-244 of such code for certain proceedings.**

The Committee on Environmental Protection, Resiliency and Waterfronts, to which the annexed proposed amended local law was referred on September 28, 2023 (Minutes, page 2534), respectfully

#### REPORTS:

**(For text of report, please see the Report of the Committee on Environmental Protection, Resiliency and Waterfronts for Int. No. 774-A printed above in these Minutes)**

*The following is the text of the Fiscal Impact Statement for Int. No. 1194-A:*

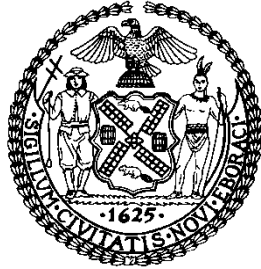

**THE COUNCIL OF THE CITY OF NEW YORK  
FINANCE DIVISION**

**TANISHA EDWARDS, CHIEF FINANCIAL OFFICER  
AND DEPUTY CHIEF OF STAFF TO THE SPEAKER**

**RICHARD LEE, DIRECTOR**

**FISCAL IMPACT STATEMENT**

**PROPOSED INT. NO. 1194-A**

**COMMITTEE:** Environmental Protection, Resiliency and Waterfronts.

**TITLE:** A Local Law to amend the administrative code of the city of New York, in relation to compensation awarded by the environmental control board to complainants for citizen noise complaints and to the maximum penalty authorized for violations of subdivision (b) of section 24-244 of such code for certain proceedings.

**Sponsors:** Council Members Gennaro, Rivera and Hanif.

**SUMMARY OF LEGISLATION:** This bill would cap the compensation citizen complainants can receive when their complaint prompts proceedings under subdivision (b) of section 24-244 of the noise code. Compensation for proceedings brought by the Department of Environmental Protection would be capped at \$5, and compensation for proceedings brought by a complainant would be capped at \$10. For citizen complaint proceedings commenced prior to the effective date of the bill for which a resolution has not yet been reached prior to such date, the maximum penalty for a violation of subdivision (b) of section 24-244 would be capped at \$50.

**EFFECTIVE DATE:** This bill would take effect immediately.

**FISCAL YEAR (FY) IN WHICH FULL FISCAL IMPACT ANTICIPATED:** FY25

**FISCAL IMPACT STATEMENT:**

	<b>Effective FY24</b>	<b>Succeeding FY25</b>	<b>Full Fiscal Impact FY25</b>
<b>Revenues (+)</b>	\$0	\$0	\$0
<b>Expenditures (-)</b>	\$0	\$0	\$0
<b>Net</b>	\$0	\$0	\$0

**IMPACT ON REVENUES:** It is estimated that there would be no impact on revenues resulting from the enactment of this legislation.

**IMPACT ON EXPENDITURES:** It is estimated that there would be no fiscal impact on expenditures resulting from the enactment of this legislation as the agencies responsible for carrying out its requirements would use existing resources to fulfill its requirements.

**SOURCE OF FUNDS TO COVER ESTIMATED COSTS:** N/A

**SOURCE OF INFORMATION:** New York City Council Finance Division

**ESTIMATE PREPARED BY:** Tanveer Singh, Legislative Financial Analyst

**ESTIMATE REVIEWED BY:** Aliya Ali, Unit Head  
Chima Obichere, Deputy Director  
Kathleen Ahn, Finance Division Counsel  
Jonathan Rosenberg, Managing Deputy Director

**LEGISLATIVE HISTORY:** This legislation was introduced to the Council on September 28, 2023, as Intro. No. 1194 and referred to the Committee on Environmental Protection, Resiliency and Waterfronts (the Committee). The legislation was considered by the Committee at a hearing held on October 16, 2023, and laid over. The legislation was subsequently amended, and the amended version, Proposed Intro. No. 1194-A will be considered by the Committee on December 6, 2023. Upon successful vote by the Committee, Proposed Intro. No. 1194-A will be submitted to the full Council for a vote on December 6, 2023.

**DATE PREPARED:** 12/05/2023.

*Accordingly, this Committee recommends its adoption, as amended.*

**(The following is the text of Int. No. 1194-A:)**

Int. No. 1194-A

By Council Members Gennaro, Rivera and Hanif.

**A local law to amend the administrative code of the city of New York, in relation to compensation awarded by the environmental control board to complainants for citizen noise complaints and to the maximum penalty authorized for violations of subdivision (b) of section 24-244 of such code for certain proceedings**

*Be it enacted by the Council as follows:*

Section 1. Subdivisions (d) and (e) of section 24-261 of the administrative code of the city of New York are amended to read as follows:

(d) In any proceeding brought by the department after receiving a complaint pursuant to subdivision (a) of this section, the board shall award the complainant, out of the proceeds collected, fair and reasonable compensation, which shall not exceed [twenty-five] 25 percent of the proceeds collected, for disclosure of information or evidence not in the possession of the department, which leads to the imposition of the civil penalty; *provided that for any proceeding brought by the department after receiving a complaint pursuant to subdivision (a) of this section alleging a violation of subdivision (b) of section 24-244, the board shall award the complainant, out of the proceeds collected, compensation in the amount of \$5.*

(e) In any proceeding brought by a complainant, the board shall award, out of the proceeds collected, [fifty] 50 percent of any civil penalty as fair and reasonable compensation to such person; *provided that for any proceeding brought by a complainant alleging a violation of subdivision (b) of section 24-244, the board shall award, out of the proceeds collected, compensation in the amount of \$10 to such person.*

§ 2. Notwithstanding the amount of the civil penalties described in table 1 of paragraph 5 of subdivision (b) of section 24-257 of the administrative code of the city of New York, the maximum amount of a civil penalty authorized to be imposed for a violation of subdivision (b) of section 24-244, in any proceeding commenced prior to the effective date of this local law pursuant to section 24-261 of such code for which a final decision and order has not been rendered prior to such date, shall be \$50.

§ 3. This local law takes effect immediately.

JAMES F. GENNARO, *Chairperson*; JENNIFER GUTIÉRREZ, KAMILLAH HANKS, ROBERT F. HOLDEN, JULIE MENIN, SANDY NURSE, LINCOLN RESTLER; 7-0-0; Committee on Environmental Protection, Resiliency & Waterfronts, December 6, 2023.

On motion of the Speaker (Council Member Adams), and adopted, the foregoing matter was coupled as a General Order for the day (see ROLL CALL ON GENERAL ORDERS FOR THE DAY).

### **Report of the Committee on Finance**

At this point, the Speaker (Council Member Adams) announced that the following items had been **preconsidered** by the Committee on Finance and had been favorably reported for adoption.

Report for L.U. No. 288

### **Report of the Committee on Finance in favor of a Resolution approving 1601 DeKalb, Block 3237, Lot 23, Brooklyn, Community District 4, Council District No. 37.**

The Committee on Finance, to which the annexed preconsidered Land Use item was referred on December 6, 2023 and which same Land Use item was coupled with the resolution shown below, respectfully

### **REPORTS:**

**(The following is the text of a Memo to the Finance Committee from the Finance Division of the New York City Council:)**

### **THE COUNCIL OF THE CITY OF NEW YORK**

December 6, 2023

TO: Hon. Justin Brannan Chair, Finance Committee  
Members of the Finance Committee

FROM: Michael Twomey, Assistant Counsel, Finance Division  
Kathleen Ahn, Counsel, Finance Division

RE: Finance Committee Agenda of December 6, 2023 – Resolution approving a tax exemption for four Land Use items (Council Districts 37, 34, 7, 10, 9)

**Item #1: 1601 DeKalb**

1601 Dekalb (the “Project”) is a new one-lobby building with two nine-story towers along Dekalb Avenue and Hart Street in the Bushwick neighborhood of Brooklyn. The Project involves the conversion of a surface parking lot on Dekalb Avenue and Hart Street into a 100% affordable residential rental building. This project will accommodate a total of 127 rent-restricted units including one superintendent’s unit, adhering to HPD’s Mix and Match program. Additionally, the development includes a tenant recreation room. There is no community and commercial space in the Project. The Project team also responded to HRA’s “Provision of Congregate Supportive Housing” RFP, and was awarded a service award grant. This will be used to focus on serving Young Adult Families with Children or Pregnant Women aged 18-25, addressing specific community needs.

**Summary:**

- Borough – Brooklyn
- Block 3237, Lot 23
- Council District – 37
- Council Member – Nurse
- Council Member approval –Yes
- Number of buildings – 1
- Number of units – 127 residential
- Type of exemption – Article XI, full, 40-year
- Population – Rental
- Sponsors – Camber Property Group
- Purpose – new construction
- Cost to the city – \$3.79 million (projected cumulative value)
- Housing Code Violations
  - Class A – 0
  - Class B – 0
  - Class C – 0

Anticipated AMI Targets: 45 units for formerly homeless, 15 units at 37% AMI, 20 units at 77% AMI, 46 units at 100% AMI

**Item #2: Sumet I**

Sumet I (“the Project”) is an apartment complex of 201 residential units located at 226 South 1st Street, Brooklyn and other nearby addresses. The sponsor is pursuing a new Article V tax exemption. All 201 units except the one super’s unit are covered under a twenty-year Project Based Rental Assistance Section 8 Mark Up to Market (MUTM) HAP contract. This property’s Article V tax exemption expired on April 27, 2020 however the property has continued to be owned and operated as an Art V since the expiration. To maintain this property as affordable housing, HPD is asking the Council for an additional period of tax exemption under Article V of the Private Housing Finance Law with retroactivity back to the original expiration. This property currently has a Project-based Mark Up to Market Housing Assistance Payments (HAP) contract. The HAP contract was issued on March 12nd, 2021 and will expire on March 31, 2041.

**Summary:**

- Borough – Brooklyn
- Block 2407, Lots 12, 14, 15, 17; Block 2408, Lots 7, 12, 14, 37, 38, 40; Block 2420, Lots 5, 43
- Council District – 34

- Council Member – Gutiérrez
- Council Member approval – Yes
- Number of buildings – 12
- Number of units – 201 residential
- Type of exemption – Article V, partial, 40 years
- Population – Rental
- Sponsors – LIHC Investment Group
- Purpose – preservation
- Cost to the city – \$9.62 million (net present value)
- Housing Code Violations
  - Class A – 1
  - Class B – 4
  - Class C – 2

Anticipated AMI Targets: 50% for all units

### **Item #3: MHANY Stella Heights LLC.PLP.FY24**

MHANY Stella Heights LLC.PLP.FY24 (“Project”) comprises of 2 buildings containing 28 rent-stabilized residential units and 55 market rate units. All units are SRO units. The Project is located in Washington Heights, Manhattan.

The Project requires a substantial rehabilitation. The scope of work includes rehabilitation to common areas and all residential units, new bathrooms, new doors and windows, a new boiler, new hot water heaters, roof, sidewalks and yard repairs. There is no community facility and commercial space in this Project. The proposed work will be a tenant-in-place renovation. In addition, the Owner will implement Aging in Place improvements in the kitchens and bathrooms. In conjunction with the Article XI, HPD will issue a new City Capital loan in participation with a senior loan provided by a private lending institution to finance this rehabilitation work.

Current rents charged average 43% of 2023 AMI. The market rents in the area average 81% of 2023 AMI according to Rent-O-Meter.

HPD will be providing a 40-year full Article XI tax exemption that will retroactively apply the tax benefit to the acquisition date to satisfy existing real estate tax arrears. Upon construction closing, the Owner will enter into a regulatory agreement that requires all units to be income and rent restricted. As part of this closing, the Owner will sign a 40-year HPD Regulatory Agreement that will set rent and income restrictions as well as require 15% homeless referral set aside for vacancies (13 units). The Owner has also been awarded 8 project-based vouchers for the property located at 575 West 155 Street to address rent burdens in low-income households. The property located at 530 West 178 Street will receive 55 Section 8 project-based vouchers under a new HAP contract through the Rental Assistance Demonstration (RAD) program.

### **Summary:**

- Borough – Manhattan
- Block 2114, Lot 70; Block 2132, Lot 30
- Council Districts – 7, 10
- Council Members – Abreu, De La Rosa
- Council Members approval – Yes
- Number of buildings – 2
- Number of units – 83 residential
- Type of exemption – Article XI, full, 40 years



- Population – Rental
- Sponsors – MHANY Management Inc.
- Purpose – preservation
- Cost to the city – \$8.78 million (net present value)
- Housing Code Violations
  - Class A – 43
  - Class B – 48
  - Class C – 25

Anticipated AMI Targets: 42 units at 30%, 21 units at 50%, 20 units at 50%

#### **Item #4: Villa Hermosa**

Villa Hermosa (“the Project”) contains three buildings and 272 units: 50 one-bedrooms, 163 two-bedrooms (one of which is reserved for the superintendent), and 59 three-bedrooms, in East Harlem, Manhattan. The Project had an Article V tax exemption that expired on June 2nd, 2020 and has continued to operate as an Article V since the expiration of the original tax exemption. In order to maintain the property as affordable housing, HPD is asking the Council, pursuant to Section 125 of the Private Housing Finance Law, for a partial Article V tax exemption for a period of 40 years beginning on the date of the original exemption expiration. This property currently has a Mark Up to Market HAP contract. The HAP contract was issued on June 6th, 2009 and will expire on February 1st, 2024.

#### **Summary:**

- Borough – Manhattan
- Block 1613, Lot 6
- Council Districts – 9
- Council Members – Richardson Jordan
- Council Members approval – Yes
- Number of buildings – 1
- Number of units – 272 residential
- Type of exemption – Article V, full, 40 years
- Population – Rental
- Sponsors – LIHC Investment Group
- Purpose – preservation
- Cost to the city – \$11.2 million (net present value)
- Housing Code Violations
  - Class A – 2
  - Class B – 1
  - Class C – 8

Anticipated AMI Targets: 50% for all units

**(For text of the coupled resolution for L.U. No. 288, please see immediately below; for text of the remaining coupled resolutions, please see, respectively, the Reports of the Committee on Finance for L.U. Nos. 289, 290, and 291 printed in these Minutes)**

*Accordingly, this Committee recommends the adoption of L.U. Nos. 288, 289, 290, and 291.*

In connection herewith, Council Member Brannan offered the following resolution:

## Preconsidered Res. No. 854

**Resolution approving an exemption from real property taxes for property located at (Block 3237, Lot 23), Brooklyn, pursuant to Section 577 of the Private Housing Finance Law (Preconsidered L.U. No. 288).**

By Council Member Brannan.

**WHEREAS**, The New York City Department of Housing Preservation and Development (“HPD”) submitted to the Council its request dated November 1, 2023 that the Council take the following action regarding a housing project located at (Block 3237, Lot 23), Brooklyn (“Exemption Area”):

Approve an exemption of the Project from real property taxes pursuant to Section 577 of the Private Housing Finance Law (the “Tax Exemption”);

**WHEREAS**, The project description that HPD provided to the Council states that the purchaser of the Project (the “Owner”) is a duly organized housing development fund company under Article XI of the Private Housing Finance Law;

**WHEREAS**, the Council has considered the financial implications relating to the Tax Exemption;

**RESOLVED:**

1. For the purposes hereof, the following terms shall have the following meanings:
  - a. “Company” shall mean 1601 Dekalb Owner LLC or another entity that acquires a beneficial leasehold interest in the Exemption Area with the prior written consent of HPD.
  - b. “Effective Date” shall mean the later of (i) the date of conveyance of the Exemption Area to the HDFC, or (ii) the date that HPD and the Owner enter into the Regulatory Agreement.
  - c. “Exemption” shall mean the exemption from real property taxation provided hereunder.
  - d. “Exemption Area” shall mean the real property located in the Borough of Brooklyn, City and State of New York, identified as Block 3237, Lot 23 on the Tax Map of the City of New York.
  - e. “Expiration Date” shall mean the earlier to occur of (i) a date which is forty (40) years from the Effective Date, (ii) the date of the expiration or termination of the Regulatory Agreement, or (iii) the date upon which the Exemption Area ceases to be owned by either a housing development fund company or an entity wholly controlled by a housing development fund company.
  - f. “HDC” shall mean the New York City Housing Development Corporation.
  - g. “HDFC” shall mean 1601 Dekalb Avenue Housing Development Fund Corporation or a housing development fund company that acquires the leasehold interest in the Exemption Area with the prior written consent of HPD.
  - h. “HPD” shall mean the Department of Housing Preservation and Development of the City of New York.
  - i. “Owner” shall mean, collectively, the HDFC and the Company.
  - j. “Regulatory Agreement” shall mean the regulatory agreement between HDC and the Owner establishing certain controls upon the operation of the Exemption Area during the term of the Exemption.

2. All of the value of the property in the Exemption Area, including both the land and any improvements (excluding those portions, if any, devoted to business, commercial, or community facility use), shall be exempt from real property taxation, other than assessments for local improvements, for a period commencing upon the Effective Date and terminating upon the Expiration Date.
3. Notwithstanding any provision hereof to the contrary:
  - a. The Exemption shall terminate if HPD determines at any time that (i) the Exemption Area is not being operated in accordance with the requirements of Article XI of the Private Housing Finance Law, (ii) the Exemption Area is not being operated in accordance with the requirements of the Regulatory Agreement, (iii) the Exemption Area is not being operated in accordance with the requirements of any other agreement with, or for the benefit of, the City of New York, (iv) any interest in the Exemption Area is conveyed or transferred to a new owner without the prior written approval of HPD, or (v) the construction or demolition of any private or multiple dwelling on the Exemption Area has commenced without the prior written consent of HPD. HPD shall deliver written notice of any such determination to Owner and all mortgagees of record, which notice shall provide for an opportunity to cure of not less than sixty (60) days. If the noncompliance specified in such notice is not cured within the time period specified therein, the Exemption shall prospectively terminate.
  - b. The Exemption shall apply to all land in the Exemption Area, but shall only apply to a building on the Exemption Area that has a new permanent certificate of occupancy or a temporary certificate of occupancy for all of the residential areas on or before five years from the Effective Date.
  - c. Nothing herein shall entitle the HDFC, the Owner, or any other person or entity to a refund of any real property taxes which accrued and were paid with respect to the Exemption Area prior to the Effective Date.
4. In consideration of the Exemption, the owner of the Exemption Area shall, for so long as the Exemption shall remain in effect, waive the benefits of any additional or concurrent exemption from or abatement of real property taxation which may be authorized under any existing or future local, state, or federal law, rule, or regulation. Notwithstanding the foregoing, (a) nothing herein shall prohibit the granting of any real property tax abatement pursuant to Sections 467-b or 467-c of the Real Property Tax Law to real property occupied by senior citizens or persons with disabilities.

JUSTIN L. BRANNAN, *Chairperson*: DIANA I. AYALA, FRANCISCO P. MOYA, KEITH POWERS, FARAH N. LOUIS, SELVENA N. BROOKS-POWERS, CHARLES BARRON, GALE A. BREWER, AMANDA FARÍAS, KAMILLAH HANKS, CRYSTAL HUDSON, CHI. A. OSSÉ, PIERINA ANA SANCHEZ, MARJORIE VELÁZQUEZ, NANTASHA M. WILLIAMS, JULIE WON, DAVID M. CARR; 17-0-0; *Absent*: Althea V. Stevens; Committee on Finance, December 6, 2024.

On motion of the Speaker (Council Member Adams), and adopted, the foregoing matter was coupled as a General Order for the day (see ROLL CALL ON GENERAL ORDERS FOR THE DAY).

At this point, the Speaker (Council Member Adams) announced that the following items had been **preconsidered** by the Committee on Finance and had been favorably reported for adoption.

Report for L.U. No. 289

**Report of the Committee on Finance in favor of a Resolution approving Sumet I, Block 2407, Lots 12, 14, 15, and 17; Block 2408, Lots 7, 12, 14, 37, 38, and 40; Block 2420, Lots 5 and 43, Brooklyn, Community District 1, Council District No. 34.**

The Committee on Finance, to which the annexed preconsidered Land Use item was referred on December 6, 2023 and which same Land Use item was coupled with the resolution shown below, respectfully

**REPORTS:**

**(For text of the Finance Memo, please see the Report of the Committee on Finance for L.U. No. 288 printed above in these Minutes)**

*Accordingly, this Committee recommends its adoption.*

In connection herewith, Council Member Brannan offered the following resolution:

Preconsidered Res. No. 855

**Resolution approving an additional period of exemption from real property taxes for property located at (Block 2407, Lots 12, 14, 15, 17; Block 2408, Lots 7, 12, 14, 37, 38, 40; Block 2420, Lots 5, 43) Brooklyn, pursuant to Section 125(1)(a-3) of the Private Housing Finance Law (Preconsidered L.U. No. 289).**

By Council Member Brannan.

**WHEREAS**, The New York City Department of Housing Preservation and Development (“HPD”) submitted to the Council its request dated November 3, 2023 that the Council take the following action regarding a housing project located at (Block 2407, Lots 12, 14, 15, 17; Block 2408, Lots 7, 12, 14, 37, 38, 40; Block 2420, Lots 5, 43) Brooklyn (“Exemption Area”):

Approve an additional period of tax exemption from real property taxes pursuant to Section 125(1)(a-3) of the Private Housing Finance Law (the “Tax Exemption”);

**WHEREAS**, The project description that HPD provided to the Council states that the owner of the Project (the “Owner”) for the subject period of the requested exemption was a duly organized housing redevelopment company formed pursuant to Article V of the Private Housing Finance Law;

**WHEREAS**, the Council has considered the financial implications relating to the Tax Exemption;

**RESOLVED:**

1. The Council hereby grants an exemption from real property taxes as follows: For the purposes hereof, the following terms shall have the following meanings:
  - a. “Company” shall mean Sumet I Associates, L.P.
  - b. “Contract Rent Deadline” shall mean three hundred and sixty-five (365) days from the date of the HPD letter requesting the information that HPD needs to calculate the Contract Rent Differential Tax for the applicable tax year.

- c. “Contract Rent Differential” shall mean the amount by which the total contract rents applicable to the Exemption Area for such tax year (as adjusted and established pursuant to Section 8 of the United States Housing Act of 1937, as amended) exceed the total contract rents which are authorized as of the Effective Date.
- d. “Contract Rent Differential Tax” shall mean the sum of (i) \$ \$1,212,513, plus (ii) twenty-five percent (25%) of the Contract Rent Differential; provided, however, that the total annual real property tax payment by the Owner shall not at any time exceed the lesser of (A) seventeen percent (17%) of the contract rents in the applicable tax year, or (B) the amount of real property taxes that would otherwise be due in the absence of any form of exemption from or abatement of real property taxation provided by an existing or future local, state, or federal law, rule, or regulation. Notwithstanding the foregoing, if the Owner fails to provide the contract rents on or before the Contract Rent Deadline, Contract Rent Differential Tax shall mean an amount equal to real property taxes that would otherwise be due in such tax year in the absence of any form of exemption from or abatement of real property taxation.
- e. “Effective Date” shall mean April 27, 2020.
- f. “Exemption” shall mean the exemption from real property taxation provided hereunder.
- g. “Exemption Area” shall mean the real property located in the Borough of Brooklyn, City and State of New York, identified as Block 2407, Lots 12, 14, 15 & 17, Block 2408, Lots 7, 12, 14, 37, 38, & 40, and Block 2420, Lots 5 & 43 on the Tax Map of the City of New York.
- h. “Expiration Date” shall mean the earlier to occur of (i) a date which is forty (40) years from the Effective Date, (ii) the date of the expiration or termination of the Land Disposition Agreement, (iii) the date of the expiration or termination of the Regulatory Agreement, (iv) the date of the expiration or termination of the Restrictive Agreement, (v) the date upon which the Exemption Area ceases to be owned by the Owner, (vi) the date upon which the City terminates the partial tax exemption pursuant to the terms of the Regulatory Agreement, or (vii) the date of the expiration or termination of the Exemption Area’s Section 8 Housing Assistance Payments contract.
- i. “HPD” shall mean the Department of Housing Preservation and Development of the City of New York.
- j. “Land Disposition Agreement” shall mean the Agreement dated December 1, 1977 between the City of New York and the Owner, establishing certain controls upon the operation of the Exemption Area in accordance with Private Housing Finance Law Section 114 and recorded on reel 989, page 490, in the office of the City Register of the City of New York.
- k. “Owner” shall mean the Company or, with the prior written approval of HPD, any future owner of the Exemption Area that is a redevelopment company organized pursuant to Article V of the Private Housing Finance Law.
- l. “Regulatory Agreement” shall mean the regulatory agreement between HPD and the Owner establishing certain controls upon the operation of the Exemption Area on and after the date such regulatory agreement is executed.
- m. “Restrictive Agreement” shall mean an agreement between HPD and the Owner that is entered into on or after November 1, 2023 and that requires the Exemption Area to remain a redevelopment company development organized under and operated pursuant to Article V of the Private Housing Finance Law for a period of forty years from the date of execution.

2. All of the value of the property in the Exemption Area, including both the land and any improvements (excluding those portions, if any, devoted to business, commercial, or community facility use), shall be exempt from real property taxation, other than assessments for local improvements, for a period commencing upon the Effective Date and terminating upon the Expiration Date.
3. Commencing upon the Effective Date, the Owner shall make real property tax payments in the sum of (i) \$1,343,083 for the period beginning on the Effective Date and ending on June 30, 2021, (ii) \$1,450,042 for the period beginning on July 1, 2021 and ending on June 30, 2022, (iii) \$1,450,042 for the period beginning on July 1, 2022 and ending on June 30, 2023, and (iv) for each year thereafter until the Expiration Date, the Contract Rent Differential Tax.
4. Notwithstanding any provision hereof to the contrary:
  - a. The Exemption shall terminate if HPD determines at any time that (i) the Exemption Area is not being operated in accordance with the requirements of Article V of the Private Housing Finance Law, (ii) the Exemption Area is not being operated in accordance with the requirements of the Land Disposition Agreement, (iii) the Exemption Area is not being operated in accordance with the Regulatory Agreement, (iv) the Exemption Area is not being operated in accordance with the requirements of the Restrictive Agreement, (v) the Exemption Area is not being operated in accordance with the requirements of any other agreement with, or for the benefit of, the City of New York, (vi) any interest in the Exemption Area is conveyed or transferred to a new owner without the prior written approval of HPD, (vii) the owner of the Exemption Area did not apply for a new Section 8 Housing Assistance Payments contract on or before March 31, 2041 or did not receive a new HAP contract effective April 1, 2041, or (viii) the construction or demolition of any private or multiple dwelling on the Exemption Area has commenced without the prior written consent of HPD. HPD shall deliver written notice of any such determination to Owner and all mortgagees of record, which notice shall provide for an opportunity to cure of not less than sixty (60) days. If the noncompliance specified in such notice is not cured within the time period specified therein, the Exemption shall prospectively terminate.
  - b. The Exemption shall apply to all land in the Exemption Area but shall only apply to buildings on the Exemption Area that exist on the Effective Date.
  - c. Nothing herein shall entitle the Company, the Owner or any other person or entity to a refund of any real property taxes which accrued and were paid with respect to the Exemption Area prior to the Effective Date.
  - d. All previous resolutions, if any, providing an exemption from or abatement of real property taxation with respect to the Exemption Area are hereby revoked as of the Effective Date.
5. In consideration of the Exemption, the owner of the Exemption Area shall (a) execute and record the Regulatory Agreement, (b) execute and record the Restrictive Agreement, and (c) for so long as the Exemption shall remain in effect, shall waive the benefits of any additional or concurrent exemption from or abatement of real property taxation which may be authorized under any existing or future local, state, or federal law, rule, or regulation. Notwithstanding the foregoing, nothing herein shall prohibit the granting of any real property tax abatement pursuant to Sections 467-b or 467-c of the Real Property Tax Law to real property occupied by senior citizens or persons with disabilities.

JUSTIN L. BRANNAN, *Chairperson*: DIANA I. AYALA, FRANCISCO P. MOYA, KEITH POWERS, FARAH N. LOUIS, SELVENA N. BROOKS-POWERS, CHARLES BARRON, GALE A. BREWER, AMANDA FARÍAS, KAMILLAH HANKS, CRYSTAL HUDSON, CHI. A. OSSÉ, PIERINA ANA SANCHEZ, MARJORIE VELÁZQUEZ, NANTASHA M. WILLIAMS, JULIE WON, DAVID M. CARR; 17-0-0; *Absent*: Althea V. Stevens; Committee on Finance, December 6, 2024.

On motion of the Speaker (Council Member Adams), and adopted, the foregoing matter was coupled as a General Order for the day (see ROLL CALL ON GENERAL ORDERS FOR THE DAY).

At this point, the Speaker (Council Member Adams) announced that the following items had been **preconsidered** by the Committee on Finance and had been favorably reported for adoption.

Report for L.U. No. 290

**Report of the Committee on Finance in favor of a Resolution approving MHANY Stella Heights LLC.PLP.FY24, Block 2114, Lot 70; Block 2132, Lot 30, Manhattan, Community District 12, Council Districts No. 7 and 10.**

The Committee on Finance, to which the annexed preconsidered Land Use item was referred on December 6, 2023 and which same Land Use item was coupled with the resolution shown below, respectfully

**REPORTS:**

**(For text of the Finance Memo, please see the Report of the Committee on Finance for L.U. No. 288 printed above in these Minutes)**

*Accordingly, this Committee recommends its adoption.*

In connection herewith, Council Member Brannan offered the following resolution:

Preconsidered Res. No. 856

**Resolution approving an exemption from real property taxes for property located at (Block 2114, Lot 70; Block 2132, Lot 30), Manhattan, pursuant to Section 577 of the Private Housing Finance Law (Preconsidered L.U. No. 290).**

By Council Member Brannan.

**WHEREAS**, The New York City Department of Housing Preservation and Development (“HPD”) submitted to the Council its request dated November 15, 2023 that the Council take the following action regarding a housing project located at (Block 2114, Lot 70; Block 2132, Lot 30), Manhattan (“Exemption Area”):

Approve an exemption of the Project from real property taxes pursuant to Section 577 of the Private Housing Finance Law (the “Tax Exemption”);

**WHEREAS**, The project description that HPD provided to the Council states that the purchaser of the Project (the “Owner”) is a duly organized housing development fund company under Article XI of the Private Housing Finance Law;

**WHEREAS**, the Council has considered the financial implications relating to the Tax Exemption;

**RESOLVED:**

1. For the purposes hereof, the following terms shall have the following meanings:
  - a. “Company” shall mean MHANY Stella Heights LLC or any other entity that acquires the beneficial interest in the Exemption Area with the prior written consent of HPD.
  - b. “Effective Date” shall mean September 6, 2019.
  - c. “Exemption” shall mean the exemption from real property taxation provided hereunder.
  - d. “Exemption Area” shall mean the real property located in the Borough of Manhattan, City and State of New York, identified as Block 2114, Lot 70 and Block 2132, Lot 30 on the Tax Map of the City of New York.
  - e. “Expiration Date” shall mean the earlier to occur of (i) a date which is forty (40) years from the Effective Date, (ii) the date of the expiration or termination of the Regulatory Agreement, or (iii) the date upon which the Exemption Area ceases to be owned by either a housing development fund company or an entity wholly controlled by a housing development fund company.
  - f. “HDFC” shall mean MHANY Stella Heights Housing Development Fund Corporation or a housing development fund company that acquires the Exemption Area with the prior written consent of HPD.
  - g. “HPD” shall mean the Department of Housing Preservation and Development of the City of New York.
  - h. “Owner” shall mean, collectively, the HDFC and the Company.
  - i. “Regulatory Agreement” shall mean the regulatory agreement between HPD and the Owner establishing certain controls upon the operation of the Exemption Area on or after the date such Regulatory Agreement is executed.
2. All of the value of the property in the Exemption Area, including both the land and any improvements (excluding those portions, if any, devoted to business, commercial, or community facility use), shall be exempt from real property taxation, other than assessments for local improvements, for a period commencing upon the Effective Date and terminating upon the Expiration Date.
3. Notwithstanding any provision hereof to the contrary:
  - a. The Exemption shall terminate if HPD determines at any time that (i) the Exemption Area is not being operated in accordance with the requirements of Article XI of the Private Housing Finance Law, (ii) the Exemption Area is not being operated in accordance with the requirements of the Regulatory Agreement, (iii) the Exemption Area is not being operated in accordance with the requirements of any other agreement with, or for the benefit of, the City of New York, (iv) any interest in the Exemption Area is conveyed or transferred to a new owner without the prior written approval of HPD, or (v) the construction or demolition of any private or multiple



dwelling on the Exemption Area has commenced without the prior written consent of HPD. HPD shall deliver written notice of any such determination to Owner and all mortgagees of record, which notice shall provide for an opportunity to cure of not less than sixty (60) days. If the noncompliance specified in such notice is not cured within the time period specified therein, the Exemption shall prospectively terminate.

- b. The Exemption shall apply to all land in the Exemption Area, but shall only apply to buildings on the Exemption Area that exist on the Effective Date.
  - c. Nothing herein shall entitle the HDFC, the Owner, or any other person or entity to a refund of any real property taxes which accrued and were paid with respect to the Exemption Area prior to the Effective Date.
4. In consideration of the Exemption, the owner of the Exemption Area shall, for so long as the Exemption shall remain in effect, waive the benefits of any additional or concurrent exemption from or abatement of real property taxation which may be authorized under any existing or future local, state, or federal law, rule, or regulation. Notwithstanding the foregoing, nothing herein shall prohibit the granting of any real property tax abatement pursuant to Sections 467-b or 467-c of the Real Property Tax Law to real property occupied by senior citizens or persons with disabilities.

JUSTIN L. BRANNAN, *Chairperson*: DIANA I. AYALA, FRANCISCO P. MOYA, KEITH POWERS, FARAH N. LOUIS, SELVENA N. BROOKS-POWERS, CHARLES BARRON, GALE A. BREWER, AMANDA FARÍAS, KAMILLAH HANKS, CRYSTAL HUDSON, CHI. A. OSSÉ, PIERINA ANA SANCHEZ, MARJORIE VELÁZQUEZ, NANTASHA M. WILLIAMS, JULIE WON, DAVID M. CARR; 17-0-0; *Absent*: Althea V. Stevens; Committee on Finance, December 6, 2024.

On motion of the Speaker (Council Member Adams), and adopted, the foregoing matter was coupled as a General Order for the day (see ROLL CALL ON GENERAL ORDERS FOR THE DAY).

At this point, the Speaker (Council Member Adams) announced that the following items had been **preconsidered** by the Committee on Finance and had been favorably reported for adoption.

Report for L.U. No. 291

**Report of the Committee on Finance in favor of a Resolution approving Villa Hermosa, Block 1613, Lot 6, Manhattan, Community District 11, Council District No. 9.**

The Committee on Finance, to which the annexed preconsidered Land Use item was referred on December 6, 2023 and which same Land Use item was coupled with the resolution shown below, respectfully

**REPORTS:**

**(For text of the Finance Memo, please see the Report of the Committee on Finance for L.U. No. 288 printed above in these Minutes)**

*Accordingly, this Committee recommends its adoption.*

In connection herewith, Council Member Brannan offered the following resolution:

## Preconsidered Res. No. 857

**Resolution approving an additional period of exemption from real property taxes for property located at (Block 1613, Lot 6) Manhattan, pursuant to Section 125(1)(a-3) of the Private Housing Finance Law (Preconsidered L.U. No. 291).**

By Council Member Brannan.

**WHEREAS**, The New York City Department of Housing Preservation and Development (“HPD”) submitted to the Council its request dated November 11, 2023 that the Council take the following action regarding a housing project located at (Block 1613, Lot 6) Manhattan (“Exemption Area”):

Approve an additional period of tax exemption from real property taxes pursuant to Section 125(1)(a-3) of the Private Housing Finance Law (the “Tax Exemption”);

**WHEREAS**, The project description that HPD provided to the Council states that the owner of the Project (the “Owner”) for the subject period of the requested exemption was a duly organized housing redevelopment company formed pursuant to Article V of the Private Housing Finance Law;

**WHEREAS**, the Council has considered the financial implications relating to the Tax Exemption;

**RESOLVED:**

1. For the purposes hereof, the following terms shall have the following meanings:
  - a) “Company” shall mean Beautiful Village Associates Redevelopment Company, L.P.
  - b) “Contract Rent Deadline” shall mean three hundred and sixty-five (365) days from the date of the HPD letter requesting the information that HPD needs to calculate the Contract Rent Differential Tax for the applicable tax year.
  - c) “Contract Rent Differential” shall mean the amount by which the total contract rents applicable to the Exemption Area for such tax year (as adjusted and established pursuant to Section 8 of the United States Housing Act of 1937, as amended) exceeded the total contract rents which are authorized as of the date of the Regulatory Agreement.
  - d) “Contract Rent Differential Tax” shall mean the sum of (i) \$1,492,155, plus (ii) twenty-five percent (25%) of the Contract Rent Differential; provided, however, that the total annual real property tax payment by the Owner shall not at any time exceed the lesser of (A) seventeen percent (17%) of the contract rents in the applicable tax year, or (B) the amount of real property taxes that would otherwise be due in the absence of any form of exemption from, or abatement of, real property taxation provided by an existing or future local, state, or federal law, rule, or regulation. Notwithstanding the foregoing, if the Owner fails to provide the contract rents on or before the Contract Rent Deadline, Contract Rent Differential Tax shall mean an amount equal to real property taxes that would otherwise be due in such tax year in the absence of any form of exemption from or abatement of real property taxation.
  - e) “Effective Date” shall mean June 2, 2020.
  - f) “Exemption” shall mean the exemption from real property taxation provided hereunder.
  - g) “Exemption Area” shall mean the real property located in the Borough of Manhattan, City and State of New York, identified as Block 1613, Lot 6 on the Tax Map of the City of New York.
  - h) “Expiration Date” shall mean the earlier to occur of (i) a date which is forty (40) years from the Effective Date, (ii) the date of the expiration or termination of the Redevelopment Agreement, (iii) the date of the expiration or termination of the Regulatory Agreement, (iv) the date of the expiration or termination of the Restrictive Agreement, (v) the date upon which the Exemption Area ceases to be owned by the Owner, (vi) the date upon which the City terminates the partial tax exemption

- pursuant to the terms of the Regulatory Agreement, or (vii) the date of the expiration or termination of the Exemption Area's Section 8 Housing Assistance Payments contract.
- i) "HPD" shall mean the Department of Housing Preservation and Development of the City of New York.
  - j) "Owner" shall mean the Company or, with the prior written approval of HPD, any future owner of the Exemption Area that is a redevelopment company organized pursuant to Article V of the Private Housing Finance Law.
  - k) "Redevelopment Agreement" shall mean the Agreement dated June 10, 1977 between the City of New York and the Owner, establishing certain controls upon the operation of the Exemption Area in accordance with Private Housing Finance Law Section 114 and recorded on reel 455, page 248, in the office of the City Register of the City of New York.
  - l) "Regulatory Agreement" shall mean the regulatory agreement between HPD and the Owner establishing certain controls upon the operation of the Exemption Area on and after the date such regulatory agreement is executed.
  - m) "Restrictive Agreement" shall mean an agreement between HPD and the Owner that is entered into on or after November 1, 2023 and that requires the Exemption Area to remain a redevelopment company development organized under and operated pursuant to Article V of the Private Housing Finance Law for a period of forty years from the date of execution.
2. All of the value of the property in the Exemption Area, including both the land and any improvements (excluding those portions, if any, devoted to business, commercial, or community facility use), shall be exempt from real property taxation, other than assessments for local improvements, for a period commencing upon the Effective Date and terminating upon the Expiration Date.
  3. Commencing upon the Effective Date, the Owner shall make real property tax payments in the sum of (i) \$1,883,188 for the period beginning on the Effective Date and ending on June 30, 2021, (ii) \$1,864,218 for the period beginning on July 1, 2021 and ending on June 30, 2022, (iii) \$1,896,178 for the period beginning on July 1, 2022 and ending on June 30, 2023, and (iv) the Contract Rent Differential Tax for each year thereafter until the Expiration Date.
  4. Notwithstanding any provision hereof to the contrary:
    - a) The Exemption shall terminate if HPD determines at any time that (i) the Exemption Area is not being operated in accordance with the requirements of Article V of the Private Housing Finance Law, (ii) the Exemption Area is not being operated in accordance with the requirements of the Redevelopment Agreement, (iii) the Exemption Area is not being operated in accordance with the Regulatory Agreement, (iv) the Exemption Area is not being operated in accordance with the requirements of the Restrictive Agreement; (v) the Exemption Area is not being operated in accordance with the requirements of any other agreement with, or for the benefit of, the City of New York, (vi) any interest in the Exemption Area is conveyed or transferred to a new owner without the prior written approval of HPD, (vii) the owner of the Exemption Area did not apply for a new Section 8 Housing Assistance Payments contract on or before January 31, 2024 or did not receive a new HAP contract effective February 1, 2024, or (viii) the construction or demolition of any private or multiple dwelling on the Exemption Area has commenced without the prior written consent of HPD. HPD shall deliver written notice of any such determination to Owner and all mortgagees of record, which notice shall provide for an opportunity to cure of not less than sixty (60) days. If the noncompliance specified in such notice is not cured within the time period specified therein, the Exemption shall prospectively terminate.
    - b) The Exemption shall apply to all land in the Exemption Area but shall only apply to a building on the Exemption Area that exists on the Effective Date.

- c) Nothing herein shall entitle the Company, the Owner or any other person or entity to a refund of any real property taxes which accrued and were paid with respect to the Exemption Area prior to the Effective Date.
  - d) All previous resolutions, if any, providing an exemption from or abatement of real property taxation with respect to the Exemption Area are hereby revoked as of the Effective Date.
5. In consideration of the Exemption, the owner of the Exemption Area shall (a) execute and record the Regulatory Agreement, and (b) for so long as the Exemption shall remain in effect, shall waive the benefits of any additional or concurrent exemption from or abatement of real property taxation which may be authorized under any existing or future local, state, or federal law, rule, or regulation. Notwithstanding the foregoing, nothing herein shall prohibit the granting of any real property tax abatement pursuant to Sections 467-b or 467-c of the Real Property Tax Law to real property occupied by senior citizens or persons with disabilities.

JUSTIN L. BRANNAN, *Chairperson*: DIANA I. AYALA, FRANCISCO P. MOYA, KEITH POWERS, FARAH N. LOUIS, SELVENA N. BROOKS-POWERS, CHARLES BARRON, GALE A. BREWER, AMANDA FARIAS, KAMILLAH HANKS, CRYSTAL HUDSON, CHI. A. OSSÉ, PIERINA ANA SANCHEZ, MARJORIE VELÁZQUEZ, NANTASHA M. WILLIAMS, JULIE WON, DAVID M. CARR; 17-0-0; *Absent*: Althea V. Stevens; Committee on Finance, December 6, 2024.

On motion of the Speaker (Council Member Adams), and adopted, the foregoing matter was coupled as a General Order for the day (see ROLL CALL ON GENERAL ORDERS FOR THE DAY).

### **Report of the Committee on Housing and Buildings**

Report for Int. No. 195-B

**Report of the Committee on Housing and Buildings in favor of approving and adopting, as amended, a Local Law to amend the administrative code of the city of New York, in relation to requiring inspection of unoccupied dwelling units.**

The Committee on Housing and Buildings, to which the annexed proposed amended local law was referred on April 14, 2022 (Minutes, page 610), respectfully

#### **REPORTS:**

#### **I. INTRODUCTION**

On December 6, 2023, the New York City Council Committee on Housing and Buildings, chaired by Council Member Pierina Sanchez, held a hearing to vote on Int. No. 195-B, sponsored by Council Member Carlina Rivera, in relation to requiring inspection of unoccupied dwelling units; Res. No. 345-B, sponsored by Council Member Pierina Sanchez, calling upon the New York State Legislature to pass, and the Governor to sign, A.1493/S.2721, in relation to establishing a New York state office of civil representation to provide access to legal services in eviction proceedings; and Res. No. 499-B, sponsored by Council Member Shaun Abreu, calling on the New York State legislature to pass, and the Governor to sign, A.4993/S.3254, requiring that any party eligible under local law for free legal counsel for an eviction proceeding may be granted an adjournment by the court for additional time to secure counsel. The Committee on Housing and Building first heard Int. No. 195-B on June 6, 2023 and Resolutions Nos. 345-B and 499-B on March 27, 2023.

## II. BACKGROUND

An excessive number of vacant units in New York City (NYC or the City) may increase citywide rent prices and decrease the quality of housing in buildings with vacancies. The absence of a unit from the rental market reduces overall housing supply and the absence of a rent regulated unit denies New Yorkers the opportunity to live in an affordable home. Further, vacant units are potential sources of gas leaks, mold, fire risk, and vermin that endanger neighboring residents.<sup>1</sup> Tenant advocates allege that no mechanism exists by which tenants can trigger the NYC Department of Housing Preservation & Development (HPD) to inspect for hazardous conditions originating from vacant units.<sup>2</sup>

According to the 2021 Housing and Vacancy Survey (HVS), the number of vacant and available rent stabilized apartments in NYC increased from 19,927 in 2017 to 45,970 in 2021.<sup>3,4</sup> The 2021 HVS also found that the number of vacant and available units of any rent regulation status increased by 30.3% between 2017 and 2021, from 79,190 to 103,200 units.<sup>5,6</sup> However recent data from the New York Department of Homes and Community Renewal (DHCR) suggests that the number of vacant, rent-stabilized units may have decreased since 2021. DHCR reported that the number of such units was 38,621 in April 2022,<sup>7</sup> which is within the expected bounds of the historic, pre-pandemic vacancy rate.<sup>8</sup>

Tenant advocates have alleged that some property owners intentionally keep rent stabilized housing units vacant in an attempt to circumvent the rent stabilization protections established by the New York State Housing Stability and Tenant Protection Act of 2019 (HSTPA).<sup>9,10</sup> This practice is commonly referred to as “warehousing.” Until DHCR amended the New York State rent stabilization rules in November 2023, holding a rent stabilized unit vacant could have allowed a property owner to increase rent if the vacant unit was physically combined with another unit. In that case, the property owner could have deregulated and charged a new, market rate rent for the combined unit.<sup>11</sup> In order to ensure that two adjacent units are vacant at the same time, a property owner may warehouse one unit until the neighboring unit’s tenant moves out.<sup>12</sup> Tenant advocates refer to this practice of combining units to increase net rent as “frankensteining.”<sup>13</sup> In November 2023, DHCR published in the New York State Register amendments to rent stabilization rules that prevent the deregulation of units through frankensteining, which will likely remove this financial incentive to hold units vacant.<sup>14</sup>

Property owner advocates counter that the vacancy rate among rent stabilized units has increased because the HSTPA limits the extent to which the costs of unit rehabilitation can be passed onto rent stabilized tenants.<sup>15</sup>

<sup>1</sup> The Coalition to End Apartment Warehousing, *Warehousing and Frankensteining* (November 2022), available at [https://drive.google.com/file/d/1pyNS6u3fKXPjLeTt\\_mNDbJXbRDtE3YL0/view](https://drive.google.com/file/d/1pyNS6u3fKXPjLeTt_mNDbJXbRDtE3YL0/view).

<sup>2</sup> Jackie Del Valle, *Testimony Concerning: Proposed Int. No. 195-A*, TakeRoot Justice (June 6, 2023), page 32, available at <https://legistar.council.nyc.gov/View.ashx?M=F&ID=12086116&GUID=2CAC7689-4FD8-4CDD-8835-C2C2BEB6A01D>.

<sup>3</sup> United States Census Bureau, *2017 New York City Housing and Vacancy Survey Microdata* (Oct. 8, 2021), available at <https://www.census.gov/programs-surveys/nycvsvs/data/datasets.html>; NYC Department of Housing Preservation and Development, *Selected Initial Findings of the 2017 New York City Housing and Vacancy Survey* (February 9, 2018), at page 1, available at <https://www.nyc.gov/assets/hpd/downloads/pdfs/about/2017-hvs-initial-findings.pdf>.

<sup>4</sup> NYC Department of Housing Preservation and Development, *2021 New York City Housing and Vacancy Survey Selected Initial Findings* (May 16, 2022), at page 25, available at <https://www.nyc.gov/assets/hpd/downloads/pdfs/services/2021-nycvsvs-selected-initial-findings.pdf>.

<sup>5</sup> NYC Department of Housing Preservation and Development, *supra* note 2 at 2

<sup>6</sup> NYC Department of Housing Preservation and Development, *supra* note 3 at 25

<sup>7</sup> David Brand, *Empty Rent-Stabilized Units in NYC Decreased This Year, as ‘Warehousing’ Debate Rages*, City Limits (Nov 17, 2022), available at <https://citylimits.org/2022/11/17/empty-rent-stabilized-units-in-nyc-decreased-this-year-as-warehousing-debate-rages/>.

<sup>8</sup> New York Department of Homes and Community Renewal, *2022 Annual Report: Office of Rent Administration*, available at [https://hcr.ny.gov/system/files/documents/2022/12/rent-annual-report-2022\\_final.pdf](https://hcr.ny.gov/system/files/documents/2022/12/rent-annual-report-2022_final.pdf).

<sup>9</sup> The Coalition to End Apartment Warehousing, *supra* note 1

<sup>10</sup> Sue Susman, Pat Loftman, Colin Kent-Daggett and Edward Ratliff, *Opinion: City’s Housing Shortage Demands an End to Apartment Warehousing*, City Limits (Aug. 26, 2022), available at <https://citylimits.org/2022/08/26/opinion-housing-shortage-calls-for-an-end-to-apartment-warehousing/>.

<sup>11</sup> Tanaz Meghiani and Sam Rabiya, *Tenants Urge State to Close the ‘Frankenstein Loophole’ That Landlords Uses to Supersize Units*, The City (Nov. 16, 2022), available at <https://www.thecity.nyc/2022/11/16/23463319/rent-stabilized-frankenstein-loophole-landlords-hcr>.

<sup>12</sup> *Id.*

<sup>13</sup> *Id.*

<sup>14</sup> Emma Whitford, *NY Quietly Finalizes Housing Regulations Cheered By ‘Frankensteining’ Critics*, City Limits (October 25, 2023), available at <https://citylimits.org/2023/10/25/ny-quietly-finalizes-housing-regulations-cheered-by-frankensteining-critics/>.

<sup>15</sup> Community Housing Improvement Program, *No One Benefits from a Vacant Apartment*, available at <https://vacancyncy.org/>.

City law requires that all units meet the standards of the Housing Maintenance Code before a new tenant moves in, which may obligate a property owner to remediate issues such as lead paint or outdated plumbing.<sup>16</sup> Pre-HSTPA, property owners could pass rehabilitation costs on to new rent stabilized tenants, but the new limitations on increasing the legal rent, according to some property owner advocates, limit an owner's ability to pay for necessary repairs and rent out vacant units.<sup>17</sup>

### III. LEGISLATION

#### **Int. No. 195-B**

This bill would require HPD to reach out to owners of multiple dwellings for which HPD has received complaints about conditions in unoccupied dwelling units that may be the cause of a hazardous or immediately hazardous condition in an occupied dwelling unit. The owner would be required to schedule an HPD inspection of such dwelling unit within 21 days. HPD would conduct an inspection of the unoccupied unit, guided by an inspection checklist, and issue violations for hazardous or immediately hazardous conditions. The bill would also allow lawful occupants of the building to apply for an order directing that HPD be provided access to the premises when necessary to correct violating conditions. This bill also includes a definition of unoccupied dwelling unit and requires building owners to keep unoccupied units in good repair.

This bill would take effect 210 days after becoming law.

#### UPDATE

On Wednesday, December 6, 2023, the Committee adopted Int. 195-B by a vote of 8 in the affirmative, 1 in the negative, 0 abstentions; Res. No. 345-B by a vote of 8 in the affirmative, 1 in the negative, 0 abstentions; Res. No. 499-B by a vote of 8 in the affirmative, 1 in the negative, 0 abstentions.

**(The following is the text of a Memo to the Finance Committee from the Finance Division of the New York City Council:)**

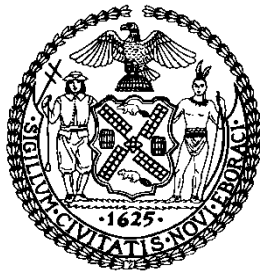

**THE COUNCIL OF THE CITY OF NEW YORK  
FINANCE DIVISION  
TANISHA S. EDWARDS, ESQ., CHIEF FINANCIAL  
OFFICER AND DEPUTY CHIEF OF STAFF TO THE  
SPEAKER  
RICHARD LEE, FINANCE DIRECTOR  
FISCAL IMPACT STATEMENT**

**PROPOSED INTRO. NO: 195-B**

**COMMITTEE: Housing and Buildings**

<sup>16</sup> *Id.*

<sup>17</sup> *Id.*

**TITLE:** A Local Law to amend the administrative code of the city of New York, in relation to requiring inspection of unoccupied dwelling units.

**SPONSOR(S):** Council Members Rivera, Brewer, Cabán, Nurse, Hanif, Farías, Avilés, Brooks-Powers, Ayala, Krishnan, Won, Richardson Jordan, Restler, Ossé, Gutiérrez, Hudson, Abreu, Bottcher, Williams, Louis, Schulman, Sanchez, Dinowitz, Joseph, De La Rosa, Feliz, Riley, Stevens, Barron, Powers, Narcisse, Marte, Hanks and The Speaker (Council Member Adams).

**SUMMARY OF LEGISLATION:** Proposed Int. No. 195-B would require the Department of Housing Preservation and Development (HPD) to reach out to owners of multiple dwellings for which HPD has received complaints about conditions in unoccupied dwelling units that may be the cause of a hazardous or immediately hazardous condition in an occupied dwelling unit. The owner would be required to schedule an HPD inspection of such dwelling unit within 21 days. HPD would conduct an inspection of the unoccupied unit, guided by an inspection checklist, and issue violations for hazardous or immediately hazardous conditions. The bill would also allow lawful occupants of the building to apply for an order directing that HPD be provided access to the premises when necessary to correct violating conditions.

**EFFECTIVE DATE:** This bill would take effect 210 days after becoming law.

**FISCAL YEAR IN WHICH FULL FISCAL IMPACT ANTICIPATED:** Fiscal Year 2026

**FISCAL IMPACT STATEMENT:**

	<b>Effective FY25</b>	<b>FY Succeeding Effective FY26</b>	<b>Full Fiscal Impact FY26</b>
<b>Revenues</b>	\$0	\$0	\$0
<b>Expenditures</b>	\$150,000	\$150,000	\$150,000
<b>Net</b>	\$150,000	\$150,000	\$150,000

**IMPACT ON REVENUES:** It is anticipated that there would be no impact on revenues resulting from the enactment of this legislation.

**IMPACT ON EXPENDITURES:** It is anticipated that the enactment of this legislation would necessitate additional technology expenditures to enable building owners to schedule appointments for inspections of unoccupied units.

**SOURCE OF FUNDS TO COVER ESTIMATED COSTS:** General Fund

**SOURCE OF INFORMATION:** New York City Council Finance Division  
 Mayor’s Office of City Legislative Affairs  
 Mayor’s Office of Management and Budget

**ESTIMATE PREPARED BY:** Daniel Kroop, Principal Financial Analyst

**ESTIMATE REVIEWED BY:** Jack Storey, Unit Head  
 Chima Obichere, Deputy Director  
 Jonathan Rosenberg, Managing Deputy Director  
 Kathleen Ahn, Counsel

**LEGISLATIVE HISTORY:** This legislation was introduced to the Council on April 14, 2022, as Int. No. 195 and was referred to the Committee on Housing and Buildings (the Committee). The Committee held a joint hearing with the Committee on Governmental Operations on June 6, 2023, and the legislation was laid over. The legislation was subsequently amended and the amended version, Proposed Int. No. 195-B, will be voted on by

the Committee at a hearing on December 6, 2023. Upon a successful vote by the Committee, Proposed Intro. No. 195-B will be submitted to the full Council for a vote on December 6, 2023.

**DATE PREPARED:** December 5, 2023.

*Accordingly, this Committee recommends its adoption, as amended.*

**(The following is the text of Int. No. 195-B:)**

Int. No. 195-B

By Council Members Rivera, Brewer, Cabán, Nurse, Hanif, Farías, Avilés, Brooks-Powers, Ayala, Krishnan, Won, Richardson Jordan, Restler, Ossé, Gutiérrez, Hudson, Abreu, Bottcher, Williams, Louis, Schulman, Sanchez, Dinowitz, Joseph, De La Rosa, Feliz, Riley, Stevens, Barron, Powers, Narcisse, Marte and The Speaker (Council Member Adams).

**A Local Law to amend the administrative code of the city of New York, in relation to requiring inspection of unoccupied dwelling units**

*Be it enacted by the Council as follows:*

Section 1. Subdivision a of section 27-2004 of the administrative code of the city of New York is amended by adding a new paragraph 50 to read as follows:

*50. The term “unoccupied dwelling unit” means a dwelling unit that is not occupied for permanent residence or temporary residence purposes.*

§ 2. Section 27-2005 of the administrative code of the city of New York is amended by adding a new subdivision h to read as follows:

*h. The owner of a multiple dwelling shall keep all unoccupied dwelling units in such multiple dwelling in good repair.*

§ 3. Article 1 of subchapter 2 of chapter 2 of title 27 of the administrative code of the city of New York is amended by adding a new section 27-2009.3 to read as follows:

*§ 27-2009.3 Inspections of unoccupied dwelling units. a. Complaints about conditions in unoccupied dwelling units affecting occupied dwelling units in multiple dwellings. Upon receipt of a complaint about pests, leaks, accumulation of refuse, unsecured openings, mold, or inadequate firestopping in an unoccupied dwelling unit of a multiple dwelling that may be the cause of a hazardous or immediately hazardous condition in an occupied dwelling unit in such multiple dwelling, other than a complaint about an unoccupied dwelling unit in a multiple dwelling owned or operated by the New York city housing authority, the department shall notify the owner of such multiple dwelling to schedule an inspection of such unoccupied dwelling unit by the department within 21 days of such complaint. Such notification shall include information about the conditions on the inspection checklist set forth in subdivision b of this section.*

*b. Inspection checklist. An inspection of an unoccupied dwelling unit conducted pursuant to subdivision a of this section shall include, but not be limited to, an inspection for the following conditions:*

- 1. Unsecured openings;*
- 2. Inadequate firestopping;*
- 3. Leaks, defective plumbing, and mold;*
- 4. Indications of the presence of any pests;*
- 5. Accumulation of refuse; and*
- 6. Smoke detectors and carbon monoxide detectors.*

*c. Notice of violation. The department shall issue a notice of violation for any hazardous or immediately hazardous condition observed in an unoccupied dwelling unit inspected pursuant to subdivision a of this section.*

*d. Publication. The department shall maintain a publicly accessible interface on the website of the department that lists violations issued pursuant to subdivision c of this section.*



§ 4. Subdivision a of section 27-2123 of the administrative code of the city of New York is amended to read as follows:

a. A judge of any civil court of competent jurisdiction may, upon appropriate application by the department, *or any lawful occupant of the premises or part thereof*, supported by an affidavit or affirmation, issue an order directing that access be provided to an officer or inspector of the department to any premises or part thereof, whenever an inspection of any premises or part therefore is required or authorized by any state or local law or regulation or entry to such area is necessary for correction of a condition violating such law or regulation.

§ 5. This local law takes effect 210 days after it becomes law.

PIERINA ANA SANCHEZ, *Chairperson*; ERIC DINOWITZ, OSWALD FELIZ, TIFFANY CABÁN, SHAUN ABREU, ALEXA AVILÉS, CHARLES BARRON, CRYSTAL HUDSON; 8-1-0; *Negative*: David M. Carr; Committee on Housing and Buildings, December 6, 2023.

On motion of the Speaker (Council Member Adams), and adopted, the foregoing matter was coupled as a General Order for the day (see ROLL CALL ON GENERAL ORDERS FOR THE DAY).

### **Report of the Committee on Land Use**

Report for L.U. No. 277

**Report of the Committee on Land Use in favor of approving, as modified, Application number N 230113 ZRY (City of Yes for Carbon Neutrality) submitted by the New York City Department of City Planning, pursuant to Section 201 of the New York City Charter, for an amendment of the Zoning Resolution of the City of New York, modifying multiple Sections to remove impediments to, and expand opportunities for, decarbonization projects within all zoning districts, Citywide.**

The Committee on Land Use, to which the annexed Land Use item was referred on October 5, 2023, (Minutes, page 2632), respectfully

#### **REPORTS:**

**(For text of the updated report, please see the Report of the Committee on Land Use for L.U. No. 277 & Res. No. 858 printed in the General Orders Calendar section of these Minutes)**

*Accordingly, this Committee recommends its adoption, as modified.*

RAFAEL SALAMANCA, Jr., *Chairperson*; CARLINA RIVERA, FARAH N. LOUIS, KEVIN C. RILEY, SELVENA N. BROOKS-POWERS, SHAUN ABREU, ERIK D. BOTTCHEER, SHEKAR KRISHNAN, DARLENE MEALY, PIERINA ANA SANCHEZ; 10-1-0; *Negative*: Joseph C. Borelli; *Absent*: Francisco P. Moya; *Conflict*: Kamillah Hanks; Committee on Land Use, November 20, 2023.

Approved with Modifications and Referred to the City Planning Commission pursuant to-Section 197-(d) of the New York City Charter.

## Report for L.U. No. 278

**Report of the Committee on Land Use in favor of approving, as modified, Application number C 220438 ZMK (Belmont Osborn Rezoning) submitted by Osborn Belmont Properties, LLC, pursuant to Sections 197-c and 201 of the New York City Charter for an amendment of the Zoning Map, Section No. 17d, eliminating from within an existing R6 District a C1-3 District, changing from an R6 District to an R7A District, changing from a C4-3 District to an R7A District, and establishing within the proposed R7A District a C2-4 District, Borough of Brooklyn, Community District 16, Council District 41.**

The Committee on Land Use, to which the annexed Land Use item was referred on October 5, 2023 (Minutes, page 2633), respectfully

**REPORTS:**

**(For text of the updated report, please see the Report of the Committee on Land Use for L.U. No. 278 & Res. No. 859 printed in the General Orders Calendar section of these Minutes)**

*Accordingly, this Committee recommends its adoption, as modified.*

RAFAEL SALAMANCA, Jr., *Chairperson*; CARLINA RIVERA, FARAH N. LOUIS, KEVIN C. RILEY, SELVENA N. BROOKS-POWERS, SHAUN ABREU, ERIK D. BOTTCHEER, SHEKAR KRISHNAN, DARLENE MEALY, PIERINA ANA SANCHEZ, JOSEPH C. BORELLI; 11-0-0; *Absent*: Francisco P. Moya; *Conflict*: Kamillah Hanks; Committee on Land Use, November 20, 2023.

Approved with Modifications and Referred to the City Planning Commission pursuant to-Section 197-(d) of the New York City Charter.

## Report for L.U. No. 279

**Report of the Committee on Land Use in favor of approving, as modified, Application number N 220439 ZRK (Belmont Osborn Rezoning) submitted by Osborn Belmont Properties, LLC, pursuant to Section 201 of the New York City Charter, for an amendment of the Zoning Resolution of the City of New York, modifying APPENDIX F for the purpose of establishing a Mandatory Inclusionary Housing area, Borough of Brooklyn, Community District 16, Council District 41.**

The Committee on Land Use, to which the annexed Land Use item was referred on October 5, 2023 (Minutes, page 2633), respectfully

**REPORTS:**

**(For text of the updated report, please see the Report of the Committee on Land Use for L.U. No. 279 & Res. No. 860 printed in the General Orders Calendar section of these Minutes)**

*Accordingly, this Committee recommends its adoption, as modified.*

RAFAEL SALAMANCA, Jr., *Chairperson*; CARLINA RIVERA, FARAH N. LOUIS, KEVIN C. RILEY, SELVENA N. BROOKS-POWERS, SHAUN ABREU, ERIK D. BOTTCHEER, SHEKAR KRISHNAN, DARLENE MEALY, PIERINA ANA SANCHEZ, JOSEPH C. BORELLI; 11-0-0; *Absent*: Francisco P. Moya; *Conflict*: Kamillah Hanks; Committee on Land Use, November 20, 2023.

Approved with Modifications and Referred to the City Planning Commission pursuant to-Section 197-(d) of the New York City Charter.

Report for L.U. No. 284

**Report of the Committee on Land Use in favor of approving, as modified, Application number C 230010 ZMK (534 Coney Island Avenue) submitted by Remica Property Group Corp., pursuant to Sections 197-c and 201 of the New York City Charter for the amendment of the Zoning Map, Section No. 22c, changing from a C8-2 District to an R7X District and establishing within the proposed R7X District a C2-4 District, Borough of Brooklyn, Community District 12, Council District 40.**

The Committee on Land Use, to which the annexed Land Use item was referred on October 19, 2023 (Minutes, page 2757), respectfully

#### REPORTS:

**(For text of the updated report, please see the Report of the Committee on Land Use for L.U. No. 284 & Res. No. 861 printed in the General Orders Calendar section of these Minutes)**

*Accordingly, this Committee recommends its adoption, as modified.*

RAFAEL SALAMANCA, Jr., *Chairperson*; CARLINA RIVERA, FARAH N. LOUIS, KEVIN C. RILEY, SELVENA N. BROOKS-POWERS, SHAUN ABREU, ERIK D. BOTTCHEER, SHEKAR KRISHNAN, DARLENE MEALY, PIERINA ANA SANCHEZ, JOSEPH C. BORELLI; 11-0-0; *Absent*: Francisco P. Moya; *Conflict*: Kamillah Hanks; Committee on Land Use, November 20, 2023.

Approved with Modifications and Referred to the City Planning Commission pursuant to-Section 197-(d) of the New York City Charter.

Report for L.U. No. 285

**Report of the Committee on Land Use in favor of approving, as modified, Application number N 230011 ZRK (534 Coney Island Avenue) submitted by Remica Property Group Corp., pursuant to Section 201 of the New York City Charter, for an amendment of the Zoning Resolution of the City of New York, modifying APPENDIX F for the purpose of establishing a Mandatory Inclusionary Housing area, Borough of Brooklyn, Community District 12, Council District 40.**

The Committee on Land Use, to which the annexed Land Use item was referred on October 19, 2023 (Minutes, page 2757), respectfully

#### REPORTS:

**(For text of the updated report, please see the Report of the Committee on Land Use for L.U. No. 285 & Res. No. 862 printed in the General Orders Calendar section of these Minutes)**

*Accordingly, this Committee recommends its adoption, as modified.*

RAFAEL SALAMANCA, Jr., *Chairperson*; CARLINA RIVERA, FARAH N. LOUIS, KEVIN C. RILEY, SELVENA N. BROOKS-POWERS, SHAUN ABREU, ERIK D. BOTTCHER, SHEKAR KRISHNAN, DARLENE MEALY, PIERINA ANA SANCHEZ, JOSEPH C. BORELLI; 11-0-0; *Absent*: Francisco P. Moya; *Conflict*: Kamillah Hanks; Committee on Land Use, November 20, 2023.

Approved with Modifications and Referred to the City Planning Commission pursuant to-Section 197-(d) of the New York City Charter.

## **Report of the Committee on Transportation and Infrastructure**

Report for Int. No. 417-B

**Report of the Committee on Transportation and Infrastructure in favor of approving and adopting, as amended, a Local Law to amend the administrative code of the city of New York, in relation to notice requirements for certain transportation projects and the repeal of section 19-187 in relation thereto.**

The Committee on Transportation and Infrastructure, to which the annexed proposed amended local law was referred on May 19, 2022 (Minutes, page 1113), respectfully

### **REPORTS:**

#### **INTRODUCTION**

On December 6, 2023, the Committee on Transportation and Infrastructure, chaired by Majority Whip Selvena N. Brooks-Powers, conducted a hearing to vote on Int. No. 417-B. Int. No. 417-B, sponsored by Council Member Lincoln Restler, in relation to notice requirements for certain transportation projects and the repeal of section 19-187 in relation thereto. A previous hearing on a prior version of Int. No. 417-B was held on April 24, 2023 entitled: Bicycles, Micromobility, and Street Enforcement. Those who testified included representatives from the New York City (NYC) Department of Transportation (DOT), New York Police Department (NYPD), the Metropolitan Transportation Authority (MTA), transportation and street safety advocates, and other interested stakeholders.

On December 6, 2023, the Committee on Transportation and Infrastructure adopted Int. No. 417-B with a vote of seven in the affirmative, five in the negative, with zero abstentions.

#### **BACKGROUND**

##### *Cycling in the City*

Cycling in NYC has rapidly expanded and improved since 1980 when the City first began collecting cycling ridership data.<sup>1</sup> This growth is, in part, due to a greater investment in cycling infrastructure by the City, enabling

---

<sup>1</sup> NYC DOT, *Cycling in the City, Cycling Trends in NYC*, September 2021, available at <https://www.nyc.gov/html/dot/downloads/pdf/cycling-in-the-city-2021.pdf>

bike riding to become a viable form of transportation for both commuting and recreation. Between 2011 and 2021, the number of people who bike to work daily in the City increased by 104 percent.<sup>2</sup> In 2021, there were approximately 550,000 cycling trips in made on an average day in NYC.<sup>3</sup> Today, approximately 888,000 adult New Yorkers regularly ride a bicycle at least several times each month.<sup>4</sup>

Along with greater investment in and commitment to cycling infrastructure, including the installation of 1,525 miles of bike lanes in the City, of which 644 miles were protected lanes (as of 2022)<sup>5</sup>, the introduction of bike sharing in the City has likely contributed to the expansion of cycling ridership. Introduced as Citi Bike in 2013, bike sharing in NYC has grown in popularity from 92,598 annual members in Fiscal Year 2014<sup>6</sup> to 227,933 annual members in Fiscal Year 2023.<sup>7</sup> Citi Bikes are retrieved by riders from one of the hundreds of stations—similar to bike racks—across NYC.<sup>8</sup> The bicycles are held in docks at such stations until unlocked by a rider, who must then return the bike to another dock in the system after a trip is complete. According to DOT’s latest *Cycling in the City* report, “[Citi Bike] makes it more convenient for New Yorkers—even those who don’t own a bicycle—to make short, point-to-point trips by bicycle and has become an integral part of New York’s transportation network.”<sup>9</sup> As of the end of September 2023, there were 1,915 active Citi Bike stations and 33,797 bikes in the fleet.<sup>10</sup>

In 2017, a new form of bike sharing, known as dockless bike share, was introduced in multiple cities across the nation.<sup>11</sup> This technology allowed for bikes within a bike share program to be picked up and dropped off at any location within a specified corridor, without the need for a traditional docking station. By the end of 2017, five major dockless bike share companies reported operating in approximately 25 cities and suburbs.<sup>12</sup> In July 2018, DOT launched its own pilot program for dockless bike share in the Rockaways in Queens, an area near Fordham University in the Bronx, on the North Shore of Staten Island, and in Coney Island, Brooklyn.<sup>13</sup> After completion of the pilot, DOT planned to create a larger borough-wide dockless bike share project on Staten Island in 2020. After releasing a Request for Expressions of Interest (RFEI) in April 2019, Beryl was selected as the new operator; however, on April 6, 2021, the company announced that it would not launch the program due to the impacts of COVID-19.<sup>14</sup> Since then, there has been no update from DOT in terms of what will be in store for the future of such a program.<sup>15</sup>

### Micromobility

The Federal Highway Administration (FHA) broadly classifies micromobility as “any small, low-speed, human- or electric-powered transportation device, including bicycles, scooters, electric-assist bicycles, electric scooters (e-scooters), and other small, lightweight, wheeled conveyances.”<sup>16</sup> Other definitions of micromobility listed by the FHA focus primarily on powered micromobility devices and characterize these devices as partially

<sup>2</sup> NYC DOT, *Cycling in the City*, available at <https://www.nyc.gov/html/dot/html/bicyclists/cyclinginthecity.shtml>

<sup>3</sup> *Id.*

<sup>4</sup> *Id.*

<sup>5</sup> *Id.*

<sup>6</sup> NYC, *Fiscal 2017 Mayor’s Management Report*, available at [https://www.nyc.gov/assets/operations/downloads/pdf/mmr2017/2017\\_mmr.pdf](https://www.nyc.gov/assets/operations/downloads/pdf/mmr2017/2017_mmr.pdf)

<sup>7</sup> NYC, *DOT Fiscal 2023 Preliminary Mayor’s Management Report*, available at <https://www.nyc.gov/assets/operations/downloads/pdf/pmmr2023/dot.pdf>

<sup>8</sup> Citi Bike, *What is a station? A dock? A kiosk?*, available at <https://help.citibikenyc.com/hc/en-us/articles/360032104712-What-is-a-station-A-dock-A-kiosk->

<sup>9</sup> *Cycling in the City*, *supra* note 1, at 15.

<sup>10</sup> Citi Bike, *Citi Bike September 2023 Monthly Report*, available at <https://mot-marketing-whitelabel-prod.s3.amazonaws.com/nyc/September-2023-Citi-Bike-Monthly-Report.pdf>

<sup>11</sup> NACTO, *Bike Share in the United States in 2017*, available at <https://nacto.org/wp-content/uploads/2018/05/NACTO-Bike-Share-2017.pdf>

<sup>12</sup> *Id.*

<sup>13</sup> NYC DOT, *Five-Borough Bike Share: DOT Names Five Dockless Bike Share Companies Assigned to Four Neighborhoods for Pilot*, available at <https://www.nyc.gov/html/dot/html/pr2018/pr18-039.shtml>

<sup>14</sup> *Id.*

<sup>15</sup> SI Live, Eric Bascome, *S.I. is only NYC borough without bike-share program, but little progress has been made to bring service here*, April 3, 2022, available at <https://www.silive.com/news/2022/04/si-is-only-nyc-borough-without-bike-share-program-but-little-progress-has-been-made-to-bring-service-here.html>

<sup>16</sup> Federal Highway Administration, Jeff Price, Danielle Blackshear, Wesley Blount Jr., and Laura Sandt, *Micromobility: A Travel Mode Innovation* (Public Roads), Spring 2021, available at <https://highways.dot.gov/public-roads/spring-2021/02>

or fully motorized, low-speed (typically less than 30 miles per hour (mph), and small size (typically less than 500 pounds and less than 3 feet wide).<sup>17</sup> According to the National Association of City Transportation Officials, users have taken half a billion trips on shared micromobility systems since 2010, with 112 million trips in 2021 alone.<sup>18</sup>

### Legalization of E-scooters and E-Bikes in the City

As a result of the rapid growth and adoption of micromobility transportation, in April 2020, New York State (NYS or State) acted to legalize certain e-bikes and e-scooters as part of the budget agreement for Fiscal Year 2021.<sup>19</sup> The budget legislation was similar to a bill that had passed the NYS Legislature in 2019, but then was ultimately vetoed by then-Governor Andrew Cuomo. The law provided localities like NYC some ability to decide whether to allow and how to regulate such vehicles.<sup>20</sup>

In July 2020, the City Council enacted Local Law 72<sup>21</sup> and Local Law 73,<sup>22</sup> amending the NYC Administrative Code to remove barriers to the use of certain e-bikes and e-scooters in the City that were authorized under NYS Law. For devices that remain illegal, fines that could be imposed pursuant to the Administrative Code were reduced from \$500 to \$250, and impoundment may now only be used for prohibited devices that have been operated in a manner that endangers the safety of the operator or safety or property of another.<sup>23</sup> In the past, the conversation around expanding legal micromobility<sup>24</sup> options in NYC had centered on e-bikes, which were used primarily by commercial cyclists.<sup>25</sup> In 2018 and 2019, the debate about legal operation of these transportation devices evolved to also include e-scooters and the adoption of e-bikes more broadly as a mode of transportation.<sup>26</sup>

### New York City's E-Scooter Pilot

In July 2020, the City Council enacted Local Law 74, requiring DOT to create a pilot program for shared e-scooters in the City.<sup>27</sup> The law required DOT to issue a solicitation for such a pilot by October 15, 2020 with the goal of having shared e-scooter organizations offering shared e-scooter services to the public by March 1, 2021.<sup>28</sup> The pilot required under Local Law 74 would run for no less than a year and no more than two years unless DOT terminated or suspended the program earlier than that timeframe.<sup>29</sup> Local Law 74 also required DOT to issue a report to the Speaker of the City Council detailing the progress of the shared e-scooter pilot.<sup>30</sup>

After issuing a RFEI in October 2020, DOT selected three companies to operate the pilot: Lime, Bird, and Veo.<sup>31</sup> On August 17, 2021, DOT launched the first phase of its e-bike pilot in the East Bronx, which

<sup>17</sup> *Id.*

<sup>18</sup> NACTO, *Half a Billion Trips: On Shared Micromobility Since 2010*, November 2022, available at [https://nacto.org/wp-content/uploads/2022/12/2020-2021\\_shared\\_micro\\_snapshot\\_Dec7\\_2022.pdf](https://nacto.org/wp-content/uploads/2022/12/2020-2021_shared_micro_snapshot_Dec7_2022.pdf)

<sup>19</sup> The Verge, Andrew J. Hawkins, *New York finally legalizes electric bikes and scooters*, April 2, 2020 available at <https://www.theverge.com/2020/4/2/21204232/new-york-legalizes-electric-bikes-scooters>

<sup>20</sup> *Id.*

<sup>21</sup> See NYC Local Law 72 of 2020, available at <https://legistar.council.nyc.gov/LegislationDetail.aspx?ID=3763645&GUID=1B9B8689-094C-46D1-8F0C-8BB71C99E149&Options=ID|Text|&Search=72>

<sup>22</sup> See NYC Local Law 73 of 2020, available at <https://legistar.council.nyc.gov/LegislationDetail.aspx?ID=3763646&GUID=5EEC4A3E-AF9D-4532-9E0E-2DE4333476F7&Options=ID|Text|&Search=73>

<sup>23</sup> Ad. Code. § 19-176.2(c)(d).

<sup>24</sup> *Micromobility* refers to the use of electronic scooters and bikes to travel shorter distances around cities, often to or from another mode of transportation (bus, train, or car). Users typically rent such a scooter or bike for a short period of time using an app. See: Dictionary, Tech and Science Dictionary, *Micromobility*, available at <https://www.dictionary.com/e/tech-science/micromobility/>

<sup>25</sup> CityLab, Vicky Gan, *The Murky Legality of E-Bikes*, February 17, 2016 available at <https://www.citylab.com/equity/2016/02/the-murky-legality-of-e-bikes/426969/>

<sup>26</sup> Bloomberg, Joshua Brustein and Nate Lanxon, *How Electric Scooters are Reshaping Cities*, September 7, 2018, available at <https://www.bloomberg.com/news/articles/2018-09-07/are-electric-scooters-the-future-of-urban-transport-quicktake>

<sup>27</sup> See NYC Local Law 74 of 2020

<sup>28</sup> *Id.*

<sup>29</sup> *Id.*

<sup>30</sup> *Id.*

<sup>31</sup> NYC DOT, *East Bronx Shared E-Scooter Pilot Final Report*, November 2022, available at <https://www.nyc.gov/html/dot/downloads/pdf/east-bronx-shared-e-scooter-pilot-report.pdf>

implemented a fleet size of up to 3,000 vehicles in the neighborhoods of Baychester, Eastchester, Edenwald, Olinville, Wakefield, Williamsbridge, Woodlawn, Allerton, Bronxdale, Indian Village, Morris Park, Pelham Gardens, Pelham Parkway, and Van Nest.<sup>32</sup> Ten months after the launch of the program, DOT initiated Phase 2 of the pilot on June 22, 2022, which doubled the fleet size of e-scooters to up to 6,000 vehicles and expanded the service into Parkchester, Soundview, Unionport, Castle Hill, Clason Point, Country Club, Edgewater Park, Schuylerville, and Throggs Neck.<sup>33</sup>

In November 2022, DOT released the corresponding mandated report which evaluated the e-scooter pilot program. DOT found that e-scooters had been widely utilized in the pilot, with an average of 2,800 trips per day.<sup>34</sup> Overall, greater than 86,000 rider accounts completed over one million trips in twelve months.<sup>35</sup> According to the report, weekdays saw higher ridership numbers than weekends and warmer months saw significantly higher trips when compared to cooler months.<sup>36</sup> The report also found that ridership along commercial corridors and near MTA transit, including subway stations, bus, and ferry stops was high, indicating that shared e-scooters provided “last-mile” connections.<sup>37</sup> Moreover, DOT concluded that the pilot had a robust safety record, with no reported fatalities and with most instances of crashes resulting in minor injuries or no injury.<sup>38</sup> Citing the success of the pilot, in November 2022, DOT Commissioner Ydanis Rodriguez released a Request for Proposals (RFP) to expand micromobility, with the capacity to make the e-scooter pilot permanent.<sup>39</sup>

In June 2023, DOT announced that the popular e-scooter share program would move beyond its pilot phase and would expand service to eastern Queens in 2024 in an effort to improve residents’ mobility and transit connections.<sup>40</sup> Bird, Lime and Veo—the three operators that provided service to the Bronx, will participate in the expansion to eastern Queens.<sup>41</sup> The program area will include Tier 1 and Tier 2 priority investment areas over roughly 20 square miles, from Flushing and Auburndale to the north down to Rochdale Village and Springfield Gardens to the south, and will provide transit connections to major transit and commercial hubs for roughly 600,000 residents.<sup>42</sup> In terms of safety, within the contractual and operational requirements for this program, DOT requires in-app safety training and quiz and age verification for new riders, while also providing a “Beginner Mode,” during which each rider’s first three trips are speed-limited at 10 mph and cannot start in overnight hours.<sup>43</sup> Also to note, the program looks at affordability and accessibility, providing discounted e-scooter share rates for those New Yorkers who receive local, state or federal assistance, and ensures that all companies provide wheelchair-accessible scooters.<sup>44</sup>

## **LEGISLATIVE ANALYSIS**

### ***Analysis of Int. No. 417-B***

Int. No. 417-B, sponsored by Council Member Restler, would consolidate the community board and council member notice requirement for bike lanes with the notice process in place for major transportation projects, and would repeal the existing standalone process for bike lanes. This would create a single, uniform, process for the department of transportation to provide notice of major transportation projects and would allow the department

---

<sup>32</sup> *Id.*

<sup>33</sup> *Id.*

<sup>34</sup> NYC DOT, *NYC DOT Announces Micromobility Pilot in East Bronx Will Move Toward Becoming a Long-Term Program, as New Report Details Success*, available at <https://nycdotscootershare.info/>

<sup>35</sup> *Id.*

<sup>36</sup> *Id.*

<sup>37</sup> NYC DOT, *East Bronx Shared E-Scooter Pilot Final Report*, November 2022, available at <https://www.nyc.gov/html/dot/downloads/pdf/east-bronx-shared-e-scooter-pilot-report.pdf>

<sup>38</sup> *Id.*

<sup>39</sup> NYC DOT, *NYC DOT Announces Micromobility Pilot in East Bronx Will Move Toward Becoming a Long-Term Program, as New Report Details Success*, available at <https://nycdotscootershare.info/>

<sup>40</sup> NYC DOT, *NYC DOT Announces Queens Expansion of E-Scooter Sharing Program*, June 15, 2023, available at <https://www.nyc.gov/html/dot/html/pr2023/e-scooter-sharing-program-queens-expansion.shtml>

<sup>41</sup> *Id.*

<sup>42</sup> *Id.*

<sup>43</sup> *Id.*

<sup>44</sup> *Id.*

to proceed with a project immediately after consideration of recommendations or comments it received during the notice period. This bill would also extend the period of time community boards have to respond to notice of a bike lane major transportation project if notified between June 20 and August 20.

If enacted, Int. No. 417-B would take effect immediately.

### **UPDATE**

On December 6, 2023, the Committee on Transportation and Infrastructure adopted Int. No. 417-B with a vote of seven in the affirmative, five in the negative, with zero abstentions.

**(The following is the text of the Fiscal Impact Statement for Int. No. 417-B:)**

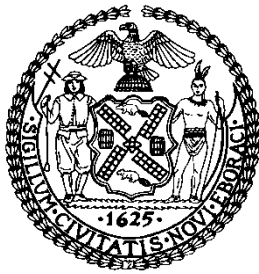

**THE COUNCIL OF THE CITY OF NEW YORK  
FINANCE DIVISION**

**TANISHA S. EDWARDS, ESQ., CHIEF FINANCIAL  
OFFICER, AND DEPUTY CHIEF OF STAFF TO THE  
SPEAKER**

**RICHARD LEE, DIRECTOR**

**FISCAL IMPACT STATEMENT**

**PROPOSED INTRO. NO: 417-B**

**COMMITTEE: Transportation and Infrastructure**

---

**TITLE:** A Local Law to amend the administrative code of the City of New York, in relation to notice requirements for certain transportation projects and the repeal of section 19-187 in relation thereto.

**SPONSOR(S):** By Council Members Restler, Krishnan, Ayala, Powers, Joseph, Bottcher, Cabán, Marte, Won, Riley, Gutiérrez, Nurse, Sanchez, Ossé, Hanif, Menin, Hudson, Avilés, Richardson Jordan, Brewer, Abreu, Schulman, Gennaro, De La Rosa, Rivera, Williams, Farías, Moya, Stevens, Feliz and Brannan (by request of the Brooklyn, Queens, Bronx and Manhattan Borough Presidents).

**SUMMARY OF LEGISLATION:** This bill would consolidate the community board and council member notice requirement for bike lanes with the notice process in place for major transportation projects, and would repeal the existing standalone process for bike lanes. This would create a single, uniform process for the department of transportation to provide notice of major transportation projects and would allow the department to proceed with a project immediately after consideration of recommendations or comments it received during the notice period. This bill would also extend the period of time community boards have to respond to notice of a bike lane major transportation project if notified between June 20 and August 20.

**EFFECTIVE DATE:** This bill would take effect immediately.

**FISCAL YEAR IN WHICH FULL FISCAL IMPACT ANTICIPATED:** Fiscal Year 2025

---



**FISCAL IMPACT STATEMENT:**

	<b>Effective FY24</b>	<b>FY Succeeding Effective FY25</b>	<b>Full Fiscal Impact FY25</b>
<b>Revenues (+)</b>	\$0	\$0	\$0
<b>Expenditures (-)</b>	\$0	\$0	\$0
<b>Net</b>	\$0	\$0	\$0

**IMPACT ON REVENUES:** It is anticipated that there would be no impact on revenues resulting from the enactment of this legislation.

**IMPACT ON EXPENDITURES:** It is anticipated that there would be no impact on expenditures resulting from the enactment of this legislation, as the New York City Department of Transportation would use existing resources to fulfill its requirements.

**SOURCE OF FUNDS TO COVER ESTIMATED COSTS:** N/A

**SOURCE OF INFORMATION:** New York City Council Finance Division

**ESTIMATE PREPARED BY:** Michael Sherman, Senior Financial Analyst

**ESTIMATE REVIEWED BY:** Jack Storey, Unit Head  
 Chima Obichere, Deputy Director  
 Jonathan Rosenberg, Managing Deputy Director  
 Kathleen Ahn, Counsel

**LEGISLATIVE HISTORY:** The legislation was introduced to the full Council on May 19, 2022, as Intro. No. 417 and referred to the Committee on Transportation and Infrastructure (the Committee). A hearing was held by the Committee on April 24, 2023 and the bill was laid over. The legislation has been amended and the amended version, Proposed Intro. No. 417-B will be considered by the Committee on December 6, 2023. Upon a successful vote by the Committee, Proposed Intro. No. 417-B will be submitted to the full Council for a vote on December 6, 2023.

**DATE PREPARED:** November 29, 2023.

*Accordingly, this Committee recommends its adoption, as amended.*

**(The following is the text of Int. No. 417-B:)**

Int. No. 417-B

By Council Members Restler, Krishnan, Ayala, Powers, Joseph, Bottcher, Cabán, Marte, Won, Riley, Gutiérrez, Nurse, Sanchez, Ossé, Hanif, Menin, Hudson, Avilés, Richardson Jordan, Brewer, Abreu, Schulman, De La Rosa, Rivera, Williams, Farías, Moya, Stevens, Feliz and Brannan (by request of the Brooklyn, Queens, Bronx and Manhattan Borough Presidents).

**A Local Law to amend the administrative code of the city of New York, in relation to notice requirements for certain transportation projects and the repeal of section 19-187 in relation thereto**

*Be it enacted by the Council as follows:*

Section 1. Subdivisions a, d, and g of section 19-101.2 of the administrative code of the city of New York, as amended by chapter 790 of the laws of 2022, are amended to read as follows:

a. *Definitions.* For the purposes of this section, the following terms [shall be defined as follows] *have the following meanings:*

[1. “[]Affected council member(s), senator(s), member(s) of assembly and community board(s)” shall mean]. *The term “affected council member(s), senator(s), member(s) of assembly and community board(s)” means the council member(s), senator(s), member(s) of assembly and community board(s) in whose districts a proposed major transportation project is to be located, in whole or in part.*

*Bicycle lane.* *The term “bicycle lane” means a portion of the roadway that has been marked off or separated for the preferential or exclusive use of bicycles.*

[2. “[]Major transportation project” shall mean]. *The term “major transportation project” means any project that[,] after construction will alter four or more consecutive blocks, or 1,000 consecutive feet of street, whichever is less, involving a major realignment of the roadway, including either removal of a vehicular lane(s) or full time removal of a parking lane(s) or addition of vehicular travel lane(s), as well as a project to add or remove a bicycle lane of any length.*

d. Within ten business days after receipt of such notice, *or within twenty business days after receipt between June 20 and August 20 of such a notice for a major transportation project for the addition or removal of a bicycle lane:* (i) the affected council member(s), senator(s) and member(s) of assembly may submit recommendations and/or comments on such notice to the department; and (ii) the affected community board(s) may either submit recommendations and/or comments on such notice to the department and/or request a presentation of the major transportation project plan by the department, which shall be made to the community board within thirty days of such community board’s request, *or within forty-five days of such community board’s request where such a notice for a major transportation project for the addition or removal of a bicycle lane is received by such community board between June 20 and August 20.*

g. The department may implement its plan [fourteen or more days] after it sends an amended plan or notice that it will proceed with its original plan to the affected council member(s), senator(s), member(s) of assembly and community board(s).

§ 2. Section 19-187 of the administrative code of the city of New York is REPEALED.

§ 3. This local law takes effect immediately.

SELVENA N. BROOKS-POWERS, *Chairperson*; CARLINA RIVERA, AMANDA FARIAS, LINDA LEE, LINCOLN RESTLER, NANTASHA M. WILLIAMS, JULIE WON; 7-5-0; *Absent:* Ari Kagan; Committee on Transportation and Infrastructure, December 6, 2023.

On motion of the Speaker (Council Member Adams), and adopted, the foregoing matter was coupled as a General Order for the day (see ROLL CALL ON GENERAL ORDERS FOR THE DAY).

## Report of the Committee on Women and Gender Equity

Report for Int. No. 1055-A

### Report of the Committee on Women and Gender Equity in favor of approving and adopting, as amended, a Local Law to amend the administrative code of the city of New York, in relation to menstrual products.

The Committee on Women and Gender Equity, to which the annexed proposed amended local law was referred on May 25, 2023 (Minutes, page 1499), respectfully

#### REPORTS:

#### I. INTRODUCTION

On Wednesday, December 6, 2023, the Committee on Women and Gender Equity, chaired by Council Member Tiffany Cabán, will consider the following legislation:

- **Proposed Int. No. 1055-A** (Cabán), A Local Law to amend the administrative code of the city of New York, in relation to menstrual products;
- **Proposed Int. No. 1056-A** (De La Rosa), A Local Law to amend the administrative code of the city of New York, in relation to the provision of menstrual products in schools;
- **Proposed Int. No. 1057-A** (Farías), A Local Law to amend the administrative code of the city of New York, in relation to requiring the department of correction to report on the distribution of menstrual products in city correctional facilities;
- **Proposed Int. No. 1058-A** (Farías), A Local Law to amend the administrative code of the city of New York, in relation to educational materials on menstrual products;
- **Proposed Int. No. 1059-A** (Farías), A Local Law to amend the administrative code of the city of New York, in relation to including menstrual cups in the definition of menstrual products and the provision of such products; and
- **Proposed Res. No. 165-A** (Louis), Resolution calling on the State Legislature to pass, and the Governor to sign, A.2583/S.15, authorizing certain shelters for victims of domestic violence to be reimbursed for any payment differential for housing a single individual in a room intended for double occupancy.

Int. No. 1055, Int. No. 1056, Int. No. 1057, Int. No. 1058, and Int. No. 1059 were heard by the Committee in a hearing with testimony from the public on September 18, 2023, and Res. No. 165 was heard by the Committee in a hearing with testimony from the public on October 25, 2023.

#### II. LEGISLATIVE ANALYSIS

##### Int. No. 1055

This bill would require the New York City (City) Department of Education (DOE) to submit to the Mayor and the Speaker and post on its website an annual report on the provision of menstrual products to students in any facility that is leased by DOE or over which DOE has care, custody, and control, in which there is a public school, including a charter school, serving students in grades six through twelve. This bill would require such report to include, for the previous year: (i) the number of schools that provided only one type of menstrual product to students; (ii) the number of schools that provided two or more types of menstrual products to students; (iii) the number of bathrooms or areas in each school where the products were made available to students, including how they were dispensed and made available; and (iv) the number of schools that did not provide

menstrual products to students, and the reasons why they were not provided. This bill would also require that all laws, documents, and materials generated by the City use the term “menstrual products” whenever referring to products such as menstrual cups, tampons, and sanitary napkins for use in connection with the menstrual cycle.

This bill received technical edits after it was heard in Committee.

**Int. No. 1056**

This bill would expand the schools in which DOE is required to provide menstrual products pursuant to administrative code section 21-968 to include schools serving students in grades 4 through 12.

This bill received technical edits after it was heard in Committee.

**Int. No. 1057**

This bill would require the City Department of Correction (DOC) to produce an annual report on its distribution of menstrual products during the preceding fiscal year beginning no later than July 31, 2025. DOC would be required to report the average daily population of individuals in custody, disaggregated by gender; the number of products ordered, disaggregated by product type; the number of products distributed to city correctional facilities, disaggregated by product type; and the number of products distributed to individuals in custody, disaggregated by product type.

After being heard, this bill received technical edits and was amended to eliminate some reporting requirements while maintaining reporting requirements in relation to the distribution of menstrual products.

**Int. No. 1058**

This bill would require DOE to develop, in collaboration with the Commission on Gender Equity, informational materials about menstrual products, to be shared with every student in grades 4 through 12.

After being heard, this bill received technical edits and was amended to require DOE to produce and provide the required informational materials rather than another City agency, and to require DOE to submit to the Mayor and the Speaker, and publish on its website, an annual report regarding the distribution of such informational materials.

**Int. No. 1059**

This bill would define the term “menstrual products” as menstrual cups, tampons, and pads, for purposes of the administrative code. This bill would also require the Department of Citywide Administrative Services to include menstrual cups in the provision of menstrual products to agencies, for further distribution to individuals in temporary shelters, and youth in secure detention or congregate care facilities. Additionally, this bill would require DOC to provide all incarcerated individuals who menstruate with either reusable or single-use menstrual cups as soon as practicable upon request.

After being heard, this bill received technical edits, and was amended to define menstrual cups to include reusable and single-use cups, and to require DOC to provide reusable cups to individuals who request them upon release.

**(The following is the text of the Fiscal Impact Statement for Int. No. 1055-A:)**

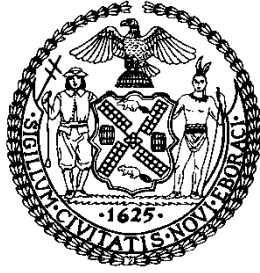

**THE COUNCIL OF THE CITY OF NEW YORK  
FINANCE DIVISION**

**TANISHA S. EDWARDS, ESQ., CHIEF FINANCIAL OFFICER, AND DEPUTY CHIEF OF STAFF TO THE SPEAKER**

**RICHARD LEE, DIRECTOR**

**FISCAL IMPACT STATEMENT**

**PROPOSED INTRO. NO: 1055-A**

**COMMITTEE: Women and Gender Equity**

**TITLE:** A Local Law to amend the administrative code of the city of New York, in relation to menstrual products.

**SPONSOR(S):** By Council Members Cabán, Farías, Stevens, Louis, Hanif, Restler, Hudson, Ossé, Riley, Gennaro, Won, Avilés, De La Rosa and Rivera.

**SUMMARY OF LEGISLATION:** This bill would require the Department of Education (DOE) to submit to the Mayor and the Speaker of the Council and post on its website an annual report on the provision of menstrual products to students in any facility that is leased by DOE or over which DOE has care, custody and control, in which there is a public school, including a charter school, serving students who menstruate in grades six through twelve. Each year, DOE would be required to report the number of such facilities that provided only one type of menstrual product to students; the number of schools that provided two or more types of menstrual products to students; the number of bathrooms or areas in each school where menstrual products were made available to students, including how they were dispensed and made available; and the number of schools that did not provide menstrual products to students, and the reasons therefor. This bill would also require that all laws, documents and materials generated by the City use the term “menstrual products” whenever referring to products for use in connection with the menstrual cycle such as menstrual cups, tampons, and menstrual pads.

**EFFECTIVE DATE:** This local law would take effect immediately

**FISCAL YEAR IN WHICH FULL FISCAL IMPACT ANTICIPATED: Fiscal 2025**

**FISCAL IMPACT STATEMENT:**

	<b>Effective FY24</b>	<b>FY Succeeding Effective FY25</b>	<b>Full Fiscal Impact FY25</b>
<b>Revenues (+)</b>	\$0	\$0	\$0
<b>Expenditures (-)</b>	\$0	\$0	\$0
<b>Net</b>	\$0	\$0	\$0

**IMPACT ON REVENUES:** It is estimated that there would be no impact on revenues resulting from the enactment of this legislation.

**IMPACT ON EXPENDITURES:** It is estimated that there would be no impact on expenditures resulting from the enactment of this legislation, as agencies responsible for carrying out its requirements would use existing resources to fulfill its requirements.

**SOURCE OF FUNDS TO COVER ESTIMATED COSTS: N/A**

**SOURCE OF INFORMATION:** New York City Council Finance Division  
New York City Office of Management and Budget

**ESTIMATE PREPARED BY:** Florentine Kabore, Unit Head

**ESTIMATE REVIEWED BY:** Crilhien R. Francisco, Assistant Director  
Elizabeth Hoffman, Assistant Director  
Chima Obichere, Deputy Director  
Kathleen Ahn, Finance Division Counsel  
Jonathan Rosenberg, Managing Deputy Director

**LEGISLATIVE HISTORY:** The legislation was first introduced to the full Council on May 25<sup>th</sup>, 2023 as Intro. No. 1055 and referred to the Committee on Women and Gender Equity (Committee). The legislation was considered by the Committee at a hearing held on September 18<sup>th</sup>, 2023, and the bill was laid over. The legislation has been amended and the amended version, Proposed Intro No. 1055-A, will be considered by the Committee on December 6<sup>th</sup>, 2023. Upon successful vote by the Committee, Proposed Intro. No. 1055-A will be submitted to the full Council for a vote on December 6<sup>th</sup>, 2023.

**DATE PREPARED:** December 1, 2023.

(For text of Int. Nos. 1056-A, 1057-A, 1058-A, 1059-A and their Fiscal Impact Statements, please see the Report of the Committee on Women and Gender Equity for Int. Nos. 1056-A, 1057-A, 1058-A, and 1059-A, respectively, printed in these Minutes; for text of Res. No. 165-A, please see the Report of the Committee on Women and Gender Equity for Res. No. 165-A printed in the voice-vote Resolutions calendar section of these Minutes; for text of Int. No. 1055-A, please see below)

*Accordingly, this Committee recommends the adoption of Int. Nos. 1055-A, 1056-A, 1057-A, 1058-A, 1059-A, and Res. No. 165-A.*

**(The following is the text of Int. No. 1055-A:)**

Int. No. 1055-A

By Council Members Cabán, Farías, Stevens, Louis, Hanif, Restler, Hudson, Ossé, Riley, Gennaro, Won, Avilés, De La Rosa and Rivera.

**A Local Law to amend the administrative code of the city of New York, in relation to menstrual products**

*Be it enacted by the Council as follows:*

Section 1. Section 1-113 of the administrative code of the city of New York is amended by adding a new subdivision f to read as follows:

f. All laws, documents, and materials generated by the city shall be drafted using the term “menstrual products” when referring to products for use in connection with the menstrual cycle such as menstrual cups, tampons, and menstrual pads.

§ 2. Section 21-968 of the administrative code of the city of New York, as added by local law number 84 for the year 2016, is amended to read as follows:

§ 21-968 Provision of [feminine hygiene] *menstrual* products in schools. a. Definitions. [For the purposes of] *As used in* this section, the following terms have the following meanings[.]:

[Feminine hygiene] *Menstrual* products. The term “[feminine hygiene] *menstrual* products” means *menstrual cups*, tampons, and [sanitary napkins] *menstrual pads* for use in connection with the menstrual cycle.

School building. The term “school building” means any facility that is leased by the department or over which the department has care, custody, and control, in which there is a public school, including a charter school, serving [female] students *who menstruate* in grades [six] 6 through [twelve] 12.

b. The department shall make [feminine hygiene] *menstrual* products available at no cost to students in bathrooms of school buildings.

c. *No later than 180 days after the effective date of the local law that added this subdivision, and annually thereafter, the department shall submit to the mayor and the speaker of the council and post on its website a report on schools’ provision of menstrual products, as required by subdivision b of this section. Such report shall include, but need not be limited to, the following information for the previous year:*

1. *The number of schools that provided only 1 type of menstrual product to students, including the brand names and types of products provided;*

2. *The number of schools that provided 2 or more types of menstrual products to students, including the brand names and types of products provided;*

3. *For schools that provided menstrual products to students, the number of bathrooms or areas in each school where such products were made available to students, including how they were dispensed or otherwise made available; and*

4. *The number of schools that did not provide menstrual products to students, and the reasons why the products were not provided.*

§ 3. Subparagraph d of paragraph 1 of subdivision a of section 20-708.1 of the administrative code of the city of New York, as amended by local law number 129 for the year 2021, is amended to read as follows:

(d) Non-prescription drugs, [feminine hygiene] *menstrual* products, and health and beauty aids.

§ 4. Paragraph 9 of subdivision b of section 21-332 of the administrative code of the city of New York, as added by local law number 62 for the year 2023, is amended to read as follows:

9. The right to receive diapers and [feminine hygiene] *menstrual* products;

§ 5. This local law takes effect immediately.

TIFFANY CABÁN, *Chairperson*; KEVIN C. RILEY, JENNIFER GUTIÉRREZ, KRISTIN RICHARDSON JORDAN, INNA VERNIKOV; 4-1-0; *Negative*: Inna Vernikov; *Absent*: James F. Gennaro and Althea V. Stevens; Committee on Women and Gender Equity, December 6, 2023.

On motion of the Speaker (Council Member Adams), and adopted, the foregoing matter was coupled as a General Order for the day (see ROLL CALL ON GENERAL ORDERS FOR THE DAY).

Report for Int. No. 1056-A

**Report of the Committee on Women and Gender Equity in favor of approving and adopting, as amended, a Local Law to amend the administrative code of the city of New York, in relation to the provision of menstrual products in schools.**

The Committee on Women and Gender Equity, to which the annexed proposed amended local law was referred on May 25, 2023 (Minutes, page 1500), respectfully

#### REPORTS:

(For text of report, please see the Report of the Committee on Women and Gender Equity for Int. No. 1055-A printed above in these Minutes)

*The following is the text of the Fiscal Impact Statement for Int. No. 1056-A:*

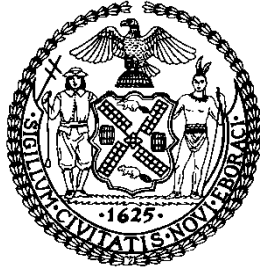

**THE COUNCIL OF THE CITY OF NEW YORK  
FINANCE DIVISION**

**TANISHA S. EDWARDS, ESQ., CHIEF FINANCIAL  
OFFICER, AND DEPUTY CHIEF OF STAFF TO THE  
SPEAKER**

**RICHARD LEE, DIRECTOR  
FISCAL IMPACT STATEMENT**

**PROPOSED INTRO. NO: 1056-A**

**COMMITTEE: Women and Gender Equity**

**TITLE:** A Local Law to amend the administrative code of the city of New York, in relation to the provision of feminine hygiene products in schools.

**SPONSOR(S):** By Council Member De La Rosa, the Speaker (Council Member Adams), and Council Members Brooks-Powers, Farías, Stevens, Louis, Hanif, Restler, Hudson, Ossé, Riley, Gennaro, Won, Avilés, Brewer, Rivera, Schulman and Cabán.

**SUMMARY OF LEGISLATION:** This bill would expand the schools in which the Department of Education is required to provide menstrual products pursuant to administrative code section 21-968 to include schools serving students in any combination of grades 4 through 12.

**EFFECTIVE DATE:** This local law would take effect immediately

**FISCAL YEAR IN WHICH FULL FISCAL IMPACT ANTICIPATED: Fiscal 2025**

**FISCAL IMPACT STATEMENT:**

	<b>Effective FY24</b>	<b>FY Succeeding Effective FY25</b>	<b>Full Fiscal Impact FY25</b>
<b>Revenues (+)</b>	\$0	\$0	\$0
<b>Expenditures (-)</b>	\$0	\$0	\$0
<b>Net</b>	\$0	\$0	\$0

**IMPACT ON REVENUES:** It is estimated that there would be no impact on revenues resulting from the enactment of this legislation.

**IMPACT ON EXPENDITURES:** It is estimated that there would be no impact on expenditures resulting from the enactment of this legislation, as agencies responsible for carrying out its requirements would use existing resources to fulfill its requirements.

**SOURCE OF FUNDS TO COVER ESTIMATED COSTS: N/A**

**SOURCE OF INFORMATION:** New York City Council Finance Division  
New York City Office of Management and Budget

**ESTIMATE PREPARED BY:** Florentine Kabore, Unit Head



**ESTIMATE REVIEWED BY:** Crilhien R. Francisco, Assistant Director  
 Elizabeth Hoffman, Assistant Director  
 Chima Obichere, Deputy Director  
 Kathleen Ahn, Finance Division Counsel  
 Jonathan Rosenberg, Managing Deputy Director

**LEGISLATIVE HISTORY:** The legislation was first introduced to the full Council on May 25<sup>th</sup>, 2023 as Intro. No. 1056 and referred to the Committee on Women and Gender Equity (Committee). The legislation was considered by the Committee at a hearing held on September 18<sup>th</sup>, 2023, and the bill was laid over. The legislation has been amended and the amended version, Proposed Intro No. 1056-A, will be considered by the Committee on December 6<sup>th</sup>, 2023. Upon successful vote by the Committee, Proposed Intro. No. 1056-A will be submitted to the full Council for a vote on December 6<sup>th</sup>, 2023.

**DATE PREPARED:** December 1, 2023.

*Accordingly, this Committee recommends its adoption, as amended.*

**(The following is the text of Int. No. 1056-A:)**

Int. No. 1056-A

By Council Member De La Rosa, the Speaker (Council Member Adams), and Council Members Brooks-Powers, Farías, Stevens, Louis, Hanif, Restler, Hudson, Ossé, Riley, Gennaro, Won, Avilés, Brewer, Rivera, Schulman and Cabán.

**A Local Law to amend the administrative code of the city of New York, in relation to the provision of menstrual products in schools**

*Be it enacted by the Council as follows:*

Section 1. The definition of “school building” set forth in subdivision a of section 21-968 of the administrative code of the city of New York, as amended by a local law for the year 2023 amending the administrative code of the city of New York, relating to menstrual products, as proposed in introduction number 1055-A, is amended to read as follows:

School building. The term "school building" means any facility that is leased by the department or over which the department has care, custody, and control, in which there is a public school, including a charter school, serving students who menstruate in *any combination of grades from grade [6] 4 through grade 12.*

§ 2. This local law takes effect on the same date as a local law for the year 2023 amending the administrative code of the city of New York, relating to menstrual products, as proposed in introduction number 1055-A, takes effect.

TIFFANY CABÁN, *Chairperson*; KEVIN C. RILEY, JENNIFER GUTIÉRREZ, KRISTIN RICHARDSON JORDAN, INNA VERNIKOV; 5-0-0; *Absent*: James F. Gennaro and Althea V. Stevens; Committee on Women and Gender Equity, December 6, 2023.

On motion of the Speaker (Council Member Adams), and adopted, the foregoing matter was coupled as a General Order for the day (see ROLL CALL ON GENERAL ORDERS FOR THE DAY).

## Report for Int. No. 1057-A

**Report of the Committee on Women and Gender Equity in favor of approving and adopting, as amended, a Local Law to amend the administrative code of the city of New York, in relation to requiring the department of correction to report on the distribution of menstrual products in city correctional facilities.**

The Committee on Women and Gender Equity, to which the annexed proposed amended local law was referred on May 25, 2023 (Minutes, page 1500), respectfully

**REPORTS:**

(For text of report, please see the Report of the Committee on Women and Gender Equity for Int. No. 1055-A printed above in these Minutes)

*The following is the text of the Fiscal Impact Statement for Int. No. 1057-A:*

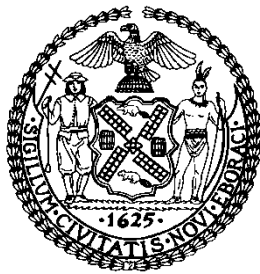

**THE COUNCIL OF THE CITY OF NEW YORK  
FINANCE DIVISION**

**TANISHA S. EDWARDS, ESQ., CHIEF FINANCIAL  
OFFICER, AND DEPUTY CHIEF OF STAFF TO THE  
SPEAKER**

**RICHARD LEE, DIRECTOR**

**FISCAL IMPACT STATEMENT**

**PROPOSED INTRO. NO: 1057-A**

**COMMITTEE: Women and Gender Equity**

**TITLE:** A Local Law to amend the administrative code of the city of New York, in relation to requiring the department of correction to report on the distribution of menstrual products in city correctional facilities.

**SPONSOR(S):** By Council Members Farías, Menin, Stevens, Louis, Hanif, Restler, Hudson, Ossé, Ayala, Narcisse, Velázquez, Krishnan, Brannan, Schulman, Brewer, Dinowitz, De La Rosa, Ung, Nurse, Abreu, Feliz, Won, Rivera, Sanchez, Williams, Joseph, Lee, Gutiérrez, Richardson Jordan, Salamanca, Riley, Powers, Botcher, Gennaro, Holden, Carr and Ariola.

**SUMMARY OF LEGISLATION:** This bill would require the Department of Correction (DOC) to produce an annual report on its distribution of menstrual products during the preceding fiscal year beginning no later than July 31, 2025. DOC would be required to report the average daily population of individuals in custody, disaggregated by gender; the number of products ordered by the department, disaggregated by product type; the number of products distributed to city correctional facilities, disaggregated by product type; and the number of products distributed to individuals in custody, disaggregated by product type.

**EFFECTIVE DATE:** This local law would take effect 270 days after becoming law

**FISCAL YEAR IN WHICH FULL FISCAL IMPACT ANTICIPATED: Fiscal 2026**

**FISCAL IMPACT STATEMENT:**

	<b>Effective FY25</b>	<b>FY Succeeding Effective FY26</b>	<b>Full Fiscal Impact FY26</b>
<b>Revenues (+)</b>	\$0	\$0	\$0
<b>Expenditures (-)</b>	\$0	\$0	\$0
<b>Net</b>	\$0	\$0	\$0

**IMPACT ON REVENUES:** It is estimated that there would be no impact on revenues resulting from the enactment of this legislation.

**IMPACT ON EXPENDITURES:** It is estimated that there would be no impact on expenditures resulting from the enactment of this legislation, as agencies responsible for carrying out its requirements would use existing resources to fulfill its requirements.

**SOURCE OF FUNDS TO COVER ESTIMATED COSTS:** N/A

**SOURCE OF INFORMATION:** New York City Council Finance Division  
New York City Office of Management and Budget

**ESTIMATE PREPARED BY:** Florentine Kabore, Unit Head

**ESTIMATE REVIEWED BY:** Crilhien R. Francisco, Assistant Director  
Elizabeth Hoffman, Assistant Director  
Chima Obichere, Deputy Director  
Kathleen Ahn, Finance Division Counsel  
Jonathan Rosenberg, Managing Deputy Director

**LEGISLATIVE HISTORY:** The legislation was first introduced to the full Council on May 25<sup>th</sup>, 2023 as Intro. No. 1057 and referred to the Committee on Women and Gender Equity (Committee). The legislation was considered by the Committee at a hearing held on September 18<sup>th</sup>, 2023, and the bill was laid over. The legislation has been amended and the amended version, Proposed Intro No. 1057-A, will be considered by the Committee on December 6<sup>th</sup>, 2023. Upon successful vote by the Committee, Proposed Intro. No. 1057-A will be submitted to the full Council for a vote on December 6<sup>th</sup>, 2023.

**DATE PREPARED:** December 1, 2023.

*Accordingly, this Committee recommends its adoption, as amended.*

**(The following is the text of Int. No. 1057-A:)**

Int. No. 1057-A

By Council Member Farías, Menin, Stevens, Louis, Hanif, Restler, Hudson, Ossé, Ayala, Narcisse, Velázquez, Krishnan, Brannan, Schulman, Brewer, Dinowitz, De La Rosa, Ung, Nurse, Abreu, Feliz, Cabán, Won, Rivera, Sanchez, Williams, Joseph, Lee, Gutiérrez, Richardson Jordan, Salamanca, Riley, Powers, Bottcher, Gennaro, Holden, Carr and Ariola.

**A Local Law to amend the administrative code of the city of New York, in relation to requiring the department of correction to report on the distribution of menstrual products in city correctional facilities**

*Be it enacted by the Council as follows:*

Section 1. Section 9-141 of the administrative code of the city of New York, as amended by chapter 322 of the laws of 2021, is amended to read as follows:

§ 9-141 [Feminine hygiene] *Menstrual* products. *a.* All [female] incarcerated individuals in the custody of the department *who are in need of menstrual products* shall be provided, at the department's expense, with [feminine hygiene] *menstrual* products as soon as practicable upon request. All [female] individuals arrested and detained in the custody of the department for at least 48 hours *who are in need of menstrual products* shall be provided, at the department's expense, with [feminine hygiene] *menstrual* products as soon as practicable upon request. For purposes of this section, "[feminine hygiene] *menstrual* products" means tampons and sanitary napkins for use in connection with the menstrual cycle.

*b. Reporting on provision of menstrual products. 1. No later than July 31, 2025, and annually thereafter, the commissioner shall submit to the mayor and the speaker of the council and post on the department's website a report on the provision of menstrual products, as required by subdivision a of this section, during the preceding fiscal year. Such report shall include the following information:*

*(a) The average daily population of individuals in the custody of the department, disaggregated by gender;*

*(b) The number of such products ordered by the department during the preceding 12 months, disaggregated by product type;*

*(c) The number of such products distributed to city correctional facilities during the preceding 12 months, disaggregated by product type; and*

*(d) The number of such products distributed to individuals in the custody of the department during the preceding 12 months, disaggregated by product type.*

§ 2. This local law takes effect 270 days after it becomes law.

TIFFANY CABÁN, *Chairperson*; KEVIN C. RILEY, JENNIFER GUTIÉRREZ, KRISTIN RICHARDSON JORDAN, INNA VERNIKOV; 5-0-0; *Absent*: James F. Gennaro and Althea V. Stevens; Committee on Women and Gender Equity, December 6, 20203.

On motion of the Speaker (Council Member Adams), and adopted, the foregoing matter was coupled as a General Order for the day (see ROLL CALL ON GENERAL ORDERS FOR THE DAY).

Report for Int. No. 1058-A

**Report of the Committee on Women and Gender Equity in favor of approving and adopting, as amended, a Local Law to amend the administrative code of the city of New York, in relation to educational materials on menstrual products.**

The Committee on Women and Gender Equity, to which the annexed proposed amended local law was referred on May 25, 2023 (Minutes, page 1501), respectfully

**REPORTS:**

**(For text of report, please see the Report of the Committee on Women and Gender Equity for Int. No. 1055-A printed above in these Minutes)**

*The following is the text of the Fiscal Impact Statement for Int. No. 1058-A:*

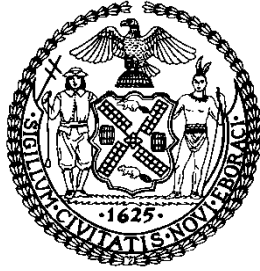

**THE COUNCIL OF THE CITY OF NEW YORK  
FINANCE DIVISION**

**TANISHA S. EDWARDS, ESQ., CHIEF FINANCIAL OFFICER, AND DEPUTY CHIEF OF STAFF TO THE SPEAKER**

**RICHARD LEE, DIRECTOR**

**FISCAL IMPACT STATEMENT**

**PROPOSED INTRO. NO: 1058-A**

**COMMITTEE: Women and Gender Equity**

**TITLE:** A Local Law to amend the administrative code of the city of New York, in relation to educational materials on menstrual products.

**SPONSOR(S):** By Council Members Farías, Menin, Stevens, Louis, Hanif, Restler, Hudson, Ossé, Ayala, Narcisse, Velázquez, Krishnan, Brannan, Schulman, Brewer, Dinowitz, De La Rosa, Ung, Nurse, Abreu, Feliz, Won, Rivera, Sanchez, Williams, Joseph, Lee, Gutiérrez, Richardson Jordan, Salamanca, Riley, Powers, Bottcher, Gennaro, Holden, Yeger, Cabán and Ariola.

**SUMMARY OF LEGISLATION:** This bill would require the Department of Education (DOE) to develop, in collaboration with the Commission on Gender Equity, informational materials about menstrual products, to be shared with every student in grades 4 through 12. This bill would also require DOE to submit to the Mayor and the Speaker, and publish on its website, an annual report regarding the distribution of such informational materials.

**EFFECTIVE DATE:** This local law would take effect immediately

**FISCAL YEAR IN WHICH FULL FISCAL IMPACT ANTICIPATED: Fiscal 2025**

**FISCAL IMPACT STATEMENT:**

	<b>Effective FY24</b>	<b>FY Succeeding Effective FY25</b>	<b>Full Fiscal Impact FY25</b>
<b>Revenues (+)</b>	\$0	\$0	\$0
<b>Expenditures (-)</b>	\$0	\$0	\$0
<b>Net</b>	\$0	\$0	\$0

**IMPACT ON REVENUES:** It is estimated that there would be no impact on revenues resulting from the enactment of this legislation.

**IMPACT ON EXPENDITURES:** It is estimated that there would be no impact on expenditures resulting from the enactment of this legislation, as agencies responsible for carrying out its requirements would use existing resources to fulfill its requirements.

**SOURCE OF FUNDS TO COVER ESTIMATED COSTS: N/A**

**SOURCE OF INFORMATION:** New York City Council Finance Division  
New York City Office of Management and Budget

**ESTIMATE PREPARED BY:** Florentine Kabore, Unit Head

**ESTIMATE REVIEWED BY:** Crilhien R. Francisco, Assistant Director  
Elizabeth Hoffman, Assistant Director  
Chima Obichere, Deputy Director  
Kathleen Ahn, Finance Division Counsel  
Jonathan Rosenberg, Managing Deputy Director

**LEGISLATIVE HISTORY:** The legislation was first introduced to the full Council on May 25<sup>th</sup>, 2023 as Intro. No. 1058 and referred to the Committee on Women and Gender Equity (Committee). The legislation was considered by the Committee at a hearing held on September 18<sup>th</sup>, 2023, and the bill was laid over. The legislation has been amended and the amended version, Proposed Intro No. 1058-A, will be considered by the Committee on December 6<sup>th</sup>, 2023. Upon successful vote by the Committee, Proposed Intro. No. 1058-A will be submitted to the full Council for a vote on December 6<sup>th</sup>, 2023.

**DATE PREPARED:** December 1, 2023.

*Accordingly, this Committee recommends its adoption, as amended.*

**(The following is the text of Int. No. 1058-A:)**

Int. No. 1058-A

By Council Member Farías, Menin, Stevens, Louis, Hanif, Restler, Hudson, Ossé, Ayala, Narcisse, Velázquez, Krishnan, Brannan, Schulman, Brewer, Dinowitz, De La Rosa, Ung, Nurse, Abreu, Feliz, Won, Rivera, Sanchez, Williams, Joseph, Lee, Gutiérrez, Richardson Jordan, Salamanca, Riley, Powers, Bottcher, Gennaro, Holden, Yeger, Cabán and Ariola.

**A Local Law to amend the administrative code of the city of New York, in relation to educational materials on menstrual products**

*Be it enacted by the Council as follows:*

Section 1. Chapter 8 of title 21-a of the administrative code of the city of New York is amended by adding a new section 21-968.1 to read as follows:

*§ 21-968.1 Education on menstrual products in schools. a. Definitions. As used in this section, the following terms have the following meanings:*

*Menstrual products. The term “menstrual products” means menstrual cups, tampons, and menstrual pads for use in connection with the menstrual cycle.*

*School. The term “school” means a school of the city school district or any public school or charter school located in a facility that is leased by the department or over which the department has care, custody, and control serving students in grades 4 through 12.*

*b. No later than 270 days after the effective date of the local law that added this section, the department, in collaboration with the commission on gender equity, shall develop informational materials about menstrual products to be shared with every student in grades 4 through 12. Such informational materials shall include:*

- 1. A description of each product;*
- 2. Information on how to use each product;*
- 3. Health information associated with each product; and*
- 4. Information about students’ right to products at no cost in school buildings.*

*c. The department shall post the informational materials required by subdivision b of this section on its website and update such materials as necessary.*

*d. No later than 1 year after the effective date of the local law that added this section, and annually thereafter, the department shall submit to the mayor and the speaker of the council and post on its website a report on the department's distribution of informational materials required by subdivision b of this section. Such report shall include a table in which each separate row references a school building. Each such row shall include the following information set forth in separate columns for the previous 6 months:*

- 1. The school name;*
- 2. The school ID;*
- 3. The number of students in grades 4 through 12;*
- 4. Whether the department provided the school with written materials created pursuant to subdivision b of this section; and*
- 5. Whether the department provided the school with such informational materials as a result of a request made by a school official, including but not limited to a principal, or whether the department provided the school such informational materials in the absence of a request for such materials.*

§ 2. This local law takes effect immediately.

TIFFANY CABÁN, *Chairperson*; KEVIN C. RILEY, JENNIFER GUTIÉRREZ, KRISTIN RICHARDSON JORDAN, INNA VERNIKOV; 5-0-0; *Absent*: James F. Gennaro and Althea V. Stevens; Committee on Women and Gender Equity, December 6, 2023.

On motion of the Speaker (Council Member Adams), and adopted, the foregoing matter was coupled as a General Order for the day (see ROLL CALL ON GENERAL ORDERS FOR THE DAY).

Report for Int. No. 1059-A

**Report of the Committee on Women and Gender Equity in favor of approving and adopting, as amended, a Local Law to amend the administrative code of the city of New York, in relation to including menstrual cups in the definition of menstrual products and the provision of such products.**

The Committee on Women and Gender Equity, to which the annexed proposed amended local law was referred on May 25, 2023 (Minutes, page 1502), respectfully

**REPORTS:**

**(For text of report, please see the Report of the Committee on Women and Gender Equity for Int. No. 1055-A printed above in these Minutes)**

*The following is the text of the Fiscal Impact Statement for Int. No. 1059-A:*

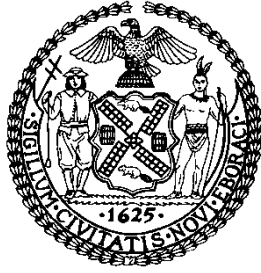

**THE COUNCIL OF THE CITY OF NEW YORK  
FINANCE DIVISION**

**TANISHA S. EDWARDS, ESQ., CHIEF FINANCIAL OFFICER, AND DEPUTY CHIEF OF STAFF TO THE SPEAKER**

**RICHARD LEE, DIRECTOR**

**FISCAL IMPACT STATEMENT**

**PROPOSED INTRO. NO: 1059-A**

**COMMITTEE: Women and Gender Equity**

**TITLE:** A Local Law to amend the administrative code of the city of New York, in relation to including menstrual cups in the definition of menstrual products and the provision of such products

**SPONSOR(S):** By Council Member Farías, the Public Advocate (Mr. Williams) and Council Members Menin, Stevens, Louis, Hanif, Restler, Hudson, Ossé, Ayala, Narcisse, Velázquez, Krishnan, Brannan, Schulman, Brewer, Dinowitz, De La Rosa, Ung, Nurse, Abreu, Feliz, Won, Rivera, Sanchez, Williams, Joseph, Lee, Gutiérrez, Richardson Jordan, Salamanca, Riley, Powers, Bottcher, Gennaro, Holden, Yeger, Cabán, Carr and Ariola.

**SUMMARY OF LEGISLATION:** This bill would define the term “menstrual products” as menstrual cups, tampons, and pads, for purposes of the administrative code. This bill would also require the Department of Citywide Administrative Services to include menstrual cups in the provision of menstrual products to agencies, for further distribution to individuals in temporary shelters, and youth in secure detention or congregate care facilities. Additionally, this bill would require the Department of Correction to provide all incarcerated individuals who menstruate with either reusable or single use menstrual cups as soon as practicable upon request.

**EFFECTIVE DATE:** This local law would take effect 270 days after becoming law

**FISCAL YEAR IN WHICH FULL FISCAL IMPACT ANTICIPATED: Fiscal 2026**

**FISCAL IMPACT STATEMENT:**

	<b>Effective FY25</b>	<b>FY Succeeding Effective FY26</b>	<b>Full Fiscal Impact FY26</b>
<b>Revenues (+)</b>	\$0	\$0	\$0
<b>Expenditures (-)</b>	\$0	\$0	\$0
<b>Net</b>	\$0	\$0	\$0

**IMPACT ON REVENUES:** It is estimated that there would be no impact on revenues resulting from the enactment of this legislation.

**IMPACT ON EXPENDITURES:** It is estimated that there would be no impact on expenditures resulting from the enactment of this legislation, as agencies responsible for carrying out its requirements would use existing resources to fulfill its requirements.

**SOURCE OF FUNDS TO COVER ESTIMATED COSTS: N/A**



**SOURCE OF INFORMATION:** New York City Council Finance Division  
New York City Office of Management and Budget

**ESTIMATE PREPARED BY:** Florentine Kabore, Unit Head

**ESTIMATE REVIEWED BY:** Crilhien R. Francisco, Assistant Director  
Elizabeth Hoffman, Assistant Director  
Chima Obichere, Deputy Director  
Kathleen Ahn, Finance Division Counsel  
Jonathan Rosenberg, Managing Deputy Director

**LEGISLATIVE HISTORY:** The legislation was first introduced to the full Council on May 25<sup>th</sup>, 2023 as Intro. No. 1059 and referred to the Committee on Women and Gender Equity (Committee). The legislation was considered by the Committee at a hearing held on September 18<sup>th</sup>, 2023, and the bill was laid over. The legislation has been amended and the amended version, Proposed Intro No. 1059-A, will be considered by the Committee on December 6<sup>th</sup>, 2023. Upon successful vote by the Committee, Proposed Intro. No. 1059-A will be submitted to the full Council for a vote on December 6<sup>th</sup>, 2023.

**DATE PREPARED:** December 1, 2023

*Accordingly, this Committee recommends its adoption, as amended.*

**(The following is the text of Int. No. 1059-A:)**

Int. No. 1059-A

By Council Member Farías, the Public Advocate (Mr. Williams) and Council Members Menin, Stevens, Louis, Hanif, Restler, Hudson, Ossé, Ayala, Narcisse, Velázquez, Krishnan, Brannan, Schulman, Brewer, Dinowitz, De La Rosa, Ung, Nurse, Abreu, Feliz, Won, Rivera, Sanchez, Williams, Joseph, Lee, Gutiérrez, Richardson Jordan, Salamanca, Riley, Powers, Bottcher, Gennaro, Holden, Yeger, Cabán, Carr and Ariola.

**A Local Law to amend the administrative code of the city of New York, in relation to including menstrual cups in the definition of menstrual products and the provision of such products**

*Be it enacted by the Council as follows:*

Section 1. Section 1-112 of the administrative code of the city of New York is amended by adding a new subdivision 23 to read as follows:

23. *“Menstrual products.” Menstrual cups, tampons, and menstrual pads for use in connection with the menstrual cycle.*

§ 2. Section 9-141 of the administrative code of the city of New York, as amended by a local law for the year 2023 amending the administrative code of the city of New York, relating to requiring the department of correction to report on the distribution of menstrual products in city correctional facilities, as proposed in introduction number 1057-A, is amended to read as follows:

§ 9-141 Menstrual products. a. *Definitions. As used in this section, the following terms have the following meanings:*

*Commissioner. The term “commissioner” means the commissioner of correction.*

*Department. The term “department” means the department of correction.*

*Menstrual cup. The term “menstrual cup” means a funnel-shaped or disc-shaped device made of either reusable or single-use material for use in connection with the menstrual cycle.*

b. *Distribution of menstrual products. 1. All incarcerated individuals in the custody of the department who are in need of menstrual products shall be provided, at the department’s expense, with menstrual products as soon as practicable upon request. All individuals arrested and detained in the custody of the department for at*

least 48 hours who are in need of menstrual products shall be provided, at the department's expense, with menstrual products as soon as practicable upon request. [For purposes of this section, "menstrual products" means tampons and sanitary napkins for use in connection with the menstrual cycle.]

2. *The department shall provide a reusable menstrual cup, at the department's expense, to any person who requests such cup upon release from the department's custody.*

[b.] c. Reporting on provision of menstrual products. 1. No later than July 31, 2025, and annually thereafter, the commissioner shall submit to the mayor and the speaker of the council and post on the department's website a report on the provision of menstrual products, as required by subdivision a of this section, during the preceding fiscal year. Such report shall include the following information:

(a) The average daily population of individuals in the custody of the department, disaggregated by gender;

(b) The number of such products ordered by the department during the preceding 12 months, disaggregated by product type;

(c) The number of such products distributed to city correctional facilities during the preceding 12 months, disaggregated by product type; and

(d) The number of such products distributed to individuals in the custody of the department during the preceding 12 months, disaggregated by product type.

§ 3. Section 12-207 of the administrative code of the city of New York, as added by local law number 83 for the year 2016, is amended to read as follows:

§ 12-207 Availability of [feminine hygiene] *menstrual* products. a. Definitions. For the purposes of this section, the following terms have the following meanings:

*Menstrual cup.* The term "menstrual cup" means a funnel-shaped device made of a reusable material such as silicone or rubber for use in connection with the menstrual cycle.

[Feminine hygiene] *Menstrual* products. The term "[feminine hygiene] *menstrual* products" means *menstrual cups*, tampons, and [sanitary napkins] *menstrual pads* for use in connection with the menstrual cycle.

Temporary shelters. The term "temporary shelters" means department of homeless services family with children shelters, adult family shelters, single adult women shelters and single adult men shelters; and human resources administration domestic violence shelters and HIV/AIDS services administration (HASA) shelters.

b. The department of citywide administrative services shall make available to agencies operating or having oversight of providers operating temporary shelters a supply of [feminine hygiene] *menstrual* products sufficient to meet the needs of residents. The department shall also make available a supply of [feminine hygiene] *menstrual* products sufficient to meet the needs of youth in secure detention facilities operated by the administration for children's services, as well as youth in congregate care facilities operated by the administration for children's services who are awaiting placement with a licensed foster care agency.

§ 4. This local law takes effect on the same date as a local law for the year 2023 amending the administrative code of the city of New York, relating to requiring the department of correction to report on the distribution of menstrual products in city correctional facilities, as proposed in introduction number 1057-A, takes effect.

TIFFANY CABÁN, *Chairperson*; KEVIN C. RILEY, JENNIFER GUTIÉRREZ, KRISTIN RICHARDSON JORDAN, INNA VERNIKOV; 5-0-0; *Absent*: James F. Gennaro and Althea V. Stevens; Committee on Women and Gender Equity, December 6, 2023.

On motion of the Speaker (Council Member Adams), and adopted, the foregoing matter was coupled as a General Order for the day (see ROLL CALL ON GENERAL ORDERS FOR THE DAY).

## **GENERAL ORDERS CALENDAR**

Report for L.U. No. 277 & Res. No. 858

**Report of the Committee on Land Use in favor of approving, as modified, Application number N 230113 ZRY (City of Yes for Carbon Neutrality) submitted by the New York City Department of City Planning, pursuant to Section 201 of the New York City Charter, for an amendment of the Zoning Resolution of the City of New York, modifying multiple Sections to remove impediments to, and expand opportunities for, decarbonization projects within all zoning districts, Citywide.**

The Committee on Land Use, to which the annexed Land Use item was referred on October 5, 2023 (Minutes, page 2632) and which same Land Use item was coupled with the resolution shown below and referred to the City Planning Commission, respectfully

### **REPORTS:**

#### **SUBJECT**

**CITYWIDE**

**N 230113 ZRY**

City Planning Commission decision approving an application submitted by the New York City Department of City Planning, pursuant to Section 201 of the New York City Charter, for an amendment of the Zoning Resolution of the City of New York, modifying multiple Sections to remove impediments to, and expand opportunities for, decarbonization projects within all zoning districts.

#### **INTENT**

To approve the zoning text amendment to several sections of the Zoning Resolution to remove impediments to, and expand opportunities for, decarbonization projects within all zoning districts and to update provisions to support the ongoing work of decarbonizing buildings and vehicles throughout our city, to reduce our city's carbon emissions and thus prevent the worst effects of climate change.

#### **PUBLIC HEARING**

**DATE:** October 4, 2023

**Witnesses in Favor:** Twenty

**Witnesses Against:** One

#### **SUBCOMMITTEE RECOMMENDATION**

**DATE:** November 20, 2023

The Subcommittee recommends that the Land Use Committee approve with modifications the decision of the City Planning Commission.

**In Favor:**

Riley  
Louis  
Abreu  
Bottcher  
Hanks  
Schulman

**Against:**

Carr

**Abstain:**

None

**COMMITTEE ACTION**

**DATE:** November 20, 2023

The Committee recommends that the Council approve the attached resolution.

**In Favor:**

Salamanca  
Rivera  
Louis  
Riley  
Abreu  
Brooks-Powers  
Bottcher  
Krishnan  
Mealy  
Sanchez

**Against:**

Borelli

**Abstain:**

None

**FILING OF MODIFICATIONS WITH THE CITY PLANNING COMMISSION**

The City Planning Commission filed a letter dated November 20, 2023, with the Council on November 20, 2023, indicating that the proposed modifications are not subject to additional environmental review or additional review pursuant to Section 197-c of the City Charter.

In connection herewith, Council Members Salamanca and Riley offered the following resolution:

Res. No. 858

**Resolution approving with modifications the decision of the City Planning Commission on Application No. N 230113 ZRY, for an amendment of the text of the Zoning Resolution (L.U. No. 277).**

By Council Members Salamanca and Riley.

**WHEREAS**, the New York City Department of City Planning, pursuant to Section 201 of the New York City Charter, for an amendment of the text of the Zoning Resolution of the City of New York, modifying multiple Sections to remove impediments to, and expand opportunities for, decarbonization projects within all zoning districts, which would update provisions to support the ongoing work of decarbonizing buildings and vehicles throughout our city, to reduce our city's carbon emissions and thus prevent the worst effects of climate

change, Citywide (ULURP No. N 230113 ZRY) (the “Application”);

**WHEREAS**, the City Planning Commission filed with the Council on October 3, 2023, its decision dated September 11, 2023 (the “Decision”), on the Application;

**WHEREAS**, the Decision is subject to review and action by the Council pursuant to Section 197-d of the City Charter;

**WHEREAS**, upon due notice, the Council held a public hearing on the Decision and Application on October 4, 2023;

**WHEREAS**, the Council has considered the land use implications and other policy issues relating to the Decision and Application; and

**WHEREAS**, the Council has considered the relevant environmental issues, including the Negative Declaration issued April 24<sup>th</sup>, 2023 (CEQR No. 23DCP135Y) (the “Negative Declaration”).

**RESOLVED:**

The Council finds that the action described herein will have no significant impact on the environment as set forth in the Negative Declaration.

Pursuant to Sections 197-d and 200 of the City Charter and on the basis of the Decision and Application, and based on the environmental determination and consideration described in the report, N 230113 ZRY, incorporated by reference herein, and the record before the Council, the Council approves the Decision of the City Planning Commission, with the following modifications.

- Matter underlined is new, to be added;
- Matter ~~struck out~~ is to be deleted;
- Matter within # # is defined in Section 12-10;
- \* \* \* indicates where unchanged text appears in the Zoning Resolution.
- Matter ~~double struck out~~ is old, deleted by the City Council;
- Matter double-underlined is new, added by the City Council

**ARTICLE I  
GENERAL PROVISIONS**

**Chapter 1  
Title, Establishment of Controls and Interpretation of Regulations**

\* \* \*

**11-30  
BUILDING PERMITS ISSUED BEFORE EFFECTIVE DATE OF AMENDMENT**

\* \* \*

**11-33  
Building Permits for Minor or Major Development or Other Construction Issued Before Effective Date of Amendment**

The provisions of this Section shall apply to minor developments, major developments or other construction authorized by building permits lawfully issued before the effective date of an applicable amendment of this Resolution except as specifically provided elsewhere in this Resolution.

\* \* \*

### **11-333**

#### **~~Residential developments with building permits issued on or before June 30, 1989~~ Special allowances for building permits issued prior to certain dates**

##### **(a) Residential developments with building permits issued on or before June 30, 1989**

[indentation added] If on or before June 30, 1989, the foundations of a #residential# major or minor development have been completed and permits issued pursuant to the requirements of Section 11-331 (Right to construct if foundations completed), and a certificate of occupancy has not been issued by June 30, 1991, construction may continue until June 30, 1995, for a minor development, or until June 30, 1997, for a major development, provided the Commissioner of Buildings determines that 30 percent of the #floor area# of the major or minor development was roofed and enclosed by walls by June 30, 1991. Applications to continue construction under this Section must be filed with the Commissioner of Buildings within 90 days of December 5, 1991. If the Commissioner of Buildings has granted the right to continue construction of a major or minor development pursuant to this Section, the Board of Standards and Appeals may not grant the right to continue construction pursuant to paragraph (a) of Section 11-332.

### **11-334**

#### **~~Building permits issued prior to June 29, 1994~~**

##### **(b) Building permits issued prior to June 29, 1994**

[indentation added] If, before June 29, 1994, a building permit has been lawfully issued, as set forth in paragraph (a) of Section 11-31, to a person with a possessory interest in a #zoning lot# authorizing construction, such construction may be started or continued for a period of one year pursuant to the regulations governing R6A, R6B, R7A, R7B, R7X, R8A, R8B, R8X, R9A, R9X or R10A Districts or #Commercial Districts# with such #Residence District bulk# regulations, or in any other district in which such construction complies with the Quality Housing Program, prior to the adoption of N940257 ZRY - Quality Housing Follow-Up Text Amendments.

### **11-335**

#### **~~Building permits for other construction in R1-2A and R2A Districts~~**

##### **(c) Building permits for other construction in R1-2A and R2A Districts**

[indentation added] In R1-2A Districts established on or after April 22, 2009, and R2A Districts established on or after December 20, 2006, if a building permit for other construction has been lawfully issued prior to the dates establishing such districts, such construction may be continued, notwithstanding the provisions of paragraph (a) of Section 11-332 (Extension of period to complete construction), provided that the Department of Buildings determines that all of the requisite structural framing to perform the work authorized under the permit was completed on or before the date establishing the district. If the Commissioner of Buildings determines that such framing was not complete on such date, the provisions of paragraph (a) of Section 11-332 shall apply.

**11-336****Building permits issued before April 30, 2008**(d) Building permits issued before April 30, 2008

[indentation added] In all districts other than R1, R2, R3, R4 or R5 Districts, if, before April 30, 2008, a building permit has been lawfully issued authorizing construction on a #zoning lot#, the provisions of N080078 ZRY, pertaining to #yards# and N080081 ZRY, pertaining to #street# trees, shall not apply, provided that foundations have been completed in accordance with paragraphs (a) and (b) of Section 11-331 (Right to construct if foundations completed), as applicable, before April 30, 2009. The provisions of Section 11-332 (Extension of period to complete construction) shall not apply.

**11-337****Building permits issued and applications filed before April 22, 2009**(e) Building permits issued and applications filed before April 22, 2009

[indentation added] If, before April 22, 2009, a building permit has been lawfully issued authorizing construction on a #zoning lot#, the provisions of N090191 ZRY, pertaining to bicycle parking, shall not apply.

If, on or before November 17, 2008, an application for a special permit or variance is pending before the Board of Standards and Appeals or an authorization or special permit from the City Planning Commission has been certified or referred to authorize construction on a #zoning lot#, the provisions of N090191 ZRY, pertaining to bicycle parking, shall not apply.

For hospitals, if, before April 22, 2009, an application for a special permit or variance is pending before the Board of Standards and Appeals or an authorization or special permit from the City Planning Commission has been filed to authorize construction on a #zoning lot#, the provisions of N090191 ZRY, pertaining to bicycle parking, shall not apply.

**11-338****Building permits issued before February 2, 2011**(f) Building permits issued before February 2, 2011

[indentation added] If a building permit has been lawfully issued on or before February 2, 2011, authorizing “other construction” as set forth in paragraph (c)(3) of Section 11-31 (General Provisions), construction pursuant to such permit may continue pursuant to the regulations governing such construction prior to the adoption of N110090(A) ZRY (Key Terms Clarification zoning text amendment) until February 2, 2012.

However, this Section shall not apply to “other construction” subject to Sections 23-692 (Height limitations for narrow buildings or enlargements) or 109-124 (Height and setback regulations).

(g) Building permits issued before [date – one year after date of adoption]

The provisions of this Section shall apply to #developments# or #enlargements# seeking building permits for #buildings# in which floor space is exempted pursuant to paragraph (12)(ii) of the definition of #floor area# as was set forth in Section 12-10 (DEFINITIONS) before [date of adoption].

If, on or before [date of adoption], an application for a #development#, #enlargement# or #conversion# has been filed with the Department of Buildings, and if, on or before [date – one year after date of adoption], the Department of Buildings has approved an application for a foundation, a new building or an alteration based on a complete zoning analysis showing zoning compliance for such #development#, #enlargement#, or #conversion#, such application may be continued, and construction may be started or continued.

#Buildings# receiving building permits pursuant to this Section shall not be considered #ultra low energy buildings#.

**~~11-339~~ 11-334**

**Building permits issued in the flood zone**

The provisions of this Section shall apply within #flood zones#. The provisions of this Section are subject to all provisions of Title 28 of the Administrative Code of the City of New York and Appendix G of the New York City Building Code, or its successors, including those pertaining to expiration, reinstatement, revocation and suspension. Changes in #flood maps# shall be considered an amendment of the Zoning Resolution for the purposes of applying the provisions of Section 11-30 (BUILDING PERMITS ISSUED BEFORE EFFECTIVE DATE OF AMENDMENT).

- (a) Construction approved pursuant to previous versions of #flood maps#

If, within one year prior to a change in the #flood maps# affecting a property, the Department of Buildings issued a building permit for construction on that property pursuant to the previous #flood maps#, the provisions of Article VI, Chapter 4 (Special Regulations Applying in Flood Hazard Areas) shall be deemed modified so as to substitute the previous #flood maps# for the current #flood maps# and such construction may continue pursuant to such prior #flood maps# until two years after the date of adoption of the new #flood maps#. After this date, the vesting provisions of Section 11-30 shall apply.

- (b) Provisions applying when Appendix A (Special Regulations for Neighborhood Recovery) of Article VI, Chapter 4 expires

This provision shall become effective only upon the expiration of Appendix A of Article VI, Chapter 4, adopted on July 23, 2015. If a building permit authorizing construction pursuant to Appendix A has been approved on or before the expiration of such Appendix, construction may continue up to two years after the expiration. After such date, the provisions of Section 11-30 shall apply.

\* \* \*

**Chapter 2  
Construction of Language and Definitions**

\* \* \*

**12-00  
RULES FOR CONSTRUCTION OF LANGUAGE**

\* \* \*



## 12-10 DEFINITIONS

Words in the text or tables of this Resolution which are italicized shall be interpreted in accordance with the provisions set forth in this Section.

\* \* \*

### Accessory use, or accessory

An "accessory use":

- (a) is a use conducted on the same zoning lot as the principal use to which it is related (whether located within the same or an accessory building or other structure, or as an accessory use of land), except that, where specifically provided in the applicable district regulations or elsewhere in this Resolution, accessory docks, off-street parking or off-street loading need not be located on the same zoning lot; and
- (b) is a use which is clearly incidental to, and customarily found in connection with, such principal use; and
- (c) is either in the same ownership as such principal #use#, or is operated and maintained ~~on the same zoning lot~~ on the same #zoning lot# substantially for the benefit or convenience of the owners, occupants, employees, customers, or visitors of ~~the~~ such principal #use#.

~~An #accessory use# may serve principal #uses# located on #zoning lots# other than the one on which the #accessory use# is located, where both such #zoning lots# constitute, or are part of, a group of #zoning lots# containing such principal #uses#, which are contiguous or would be contiguous but for the separation of #streets#, and are under same single fee ownership or alternate ownership arrangement. In such cases, the evaluation of whether the #accessory use# is clearly incidental to the principal #uses# shall consider all #zoning lots# containing such principal #uses#.~~

When "accessory" is used in the text, it shall have the same meaning as accessory use.

An #accessory use# includes, but is not limited to:

- (1) Living or sleeping accommodations for servants in connection with a #use# listed in Use Groups 1 and 2;
- (2) Living or sleeping accommodations for caretakers in connection with any #use# listed in Use Groups 3 through 18 inclusive, provided that:
  - (i) no #building# contains more than one living or sleeping accommodation for caretakers;
  - (ii) no such living or sleeping accommodation shall exceed 1,200 square feet of #floor area#;
  - (iii) the owner shall sign a Restrictive Declaration that any such caretaker will provide maintenance and/or repair services, and containing a list of services to be performed by such caretaker. Such Restrictive Declaration shall be recorded in the Office of the City Register, or, where applicable, the County Clerk's Office, of the county where the #building# is located. A copy of such declaration shall be provided to the Department of Buildings;

- (iv) in C6-2M, C6-4M, M1-5M, M1-6M and M1-5B Districts, no living or sleeping accommodation for caretakers is permitted in any #building# which contains a #residential use# or a #joint living-work quarters for artists#; and
  - (v) such living or sleeping accommodation shall not be considered a #residential use# or cause a #building# to be considered a #mixed building#.
- (3) Living or sleeping accommodations in connection with #commercial# or #manufacturing uses#, including living or sleeping accommodations in connection with a studio listed in Use Group 9, provided that:
- (i) no #building# contains more than two kitchens; and
  - (ii) no such living or sleeping accommodations are located in a C7, C8 or #Manufacturing District#.
- (4) Keeping of domestic animals, but not for sale or hire. A #commercial# stable or kennel is not an #accessory use#.
- (5) Swimming pools not located within a #building# listed in Use Group 1 or 2, provided that:
- (i) the #use# of such pools shall be restricted to occupants of the principal #use# and guests for whom no admission or membership fees are charged;
  - (ii) if #accessory# to a #use# listed in Use Group 2, except if such #use# is a #single-family# or #two-family residence#, the edge of the pool shall be located not less than 100 feet from any #lot line#;
  - (iii) if #accessory# to a #use# listed in Use Group 1 or Use Group 2, which #use# is a #single-family residence# or #two-family residence#, the edge of the pool shall be located not less than five feet from any #lot line#, except that such minimum distance between the edge of the pool and any #side lot line# may be not less than three feet in the case of lots less than 25 feet in width, providing that it is screened from adjoining lots by a six foot high continuous solid opaque fence along the #side lot line# adjacent to such pool. In the event that such pool is located between 50 and five feet from any #rear lot line# or #side lot line#, it shall be screened by a continuous fence supplemented with a strip of densely planted trees or shrubs at least four feet high at the time of planting along such #rear lot line# to such pool; and
  - (iv) illumination of such pools shall be limited to underwater lighting.
- Swimming pool clubs are not #accessory uses#.
- (6) Domestic or agricultural storage in a barn, shed, tool room, or similar #building or other structure#.
  - (7) #Home occupations#.
  - (8) A newsstand primarily for the convenience of the occupants of a #building#, which is located wholly within such #building# and has no exterior #signs# or displays.
  - (9) Incinerators.
  - (10) In connection with #commercial# or #manufacturing uses#, the storage of goods normally carried in stock, used in, or produced by such #uses#, unless the storage is expressly prohibited under the

applicable district regulation. The #floor area# used for such #accessory# storage shall be included in the maximum #floor area# permitted for specified #uses# set forth in the Use Groups.

- (11) Incidental repairs, unless expressly prohibited under the applicable district regulations. The #floor area# used for such #accessory# repairs shall be included in the maximum #floor area# permitted for specified #uses# set forth in the Use Groups.
- (12) The removal for sale of sod, loam, clay, sand, gravel or stone in connection with the construction of a #building or other structure# on the same #zoning lot#, or in connection with the regrading of a #zoning lot#, but in the latter case, not below the legal #street# grade.
- (13) #Accessory# off-street parking spaces, ~~open or enclosed.~~
- (14) #Accessory# off-street loading berths.
- (15) #Accessory signs#.
- (16) #Accessory# radio or television towers.
- (17) #Accessory# activities when conducted underground as part of the operation of railroad passenger terminals, such as switching, storage, maintenance or servicing of trains.
- (18) #Accessory# sewage disposal plants, except such plants serving more than 50 #dwelling units#.
- (19) An ambulance outpost operated by or under contract with a government agency or a public benefit corporation and located either on the same #zoning lot# as, or on a #zoning lot# adjacent to, a #zoning lot# occupied by a fire or police station.
- (20) ~~Electric vehicle charging in connection with parking facilities.~~
- (21) ~~Solar energy systems~~
- (20) Composting, without prohibition on the sale of compost to customers, or on the acceptance of organic material produced on another zoning lot.
- (21) #Accessory# mechanical equipment, including equipment serving the following #building# systems:
  - (i) mechanical, electrical, or plumbing systems;
  - (ii) fire protection systems;
  - (iii) power systems, including, energy generation systems such as solar or wind energy systems and generators; and
  - (iv) energy storage systems, where the amount of energy being stored shall not exceed 24 hours of the electrical load generated at peak demand by the principal #use# on the #zoning lot#. Where a #zoning lot# contains multiple #uses#, such calculation may be applied to the total demand of all the #uses# such power system is #accessory# to.

#Accessory# mechanical equipment shall be subject to the provisions of Sections 26-60 (SPECIAL SCREENING AND ENCLOSURE PROVISIONS), or 37-20, as applicable.

\* \* \*

**Attached (building)**

A #building# shall be considered “attached” when it #abuts# two #lot lines# other than a #street line#, or another #building# or #buildings# other than a #semi-detached building#.

**Automated parking facility**

An “automated parking facility” shall refer to an #accessory# off-street parking facility or #public parking garage# where vehicular storage and retrieval within such facility is accomplished entirely through a mechanical conveyance system. A parking facility with parking lift systems that require an attendant to maneuver a vehicle that is to be parked shall not be considered an #automated parking facility#.

**Automotive service station**

An "automotive service station" is a #building or other structure# or an open #use# on a #zoning lot#, or portion thereof, used exclusively for the storage and sale of ~~gasoline or other motor~~ fuels for motor vehicles, and for any #uses accessory# thereto.

The sale of lubricants, accessories, or supplies, the lubrication of motor vehicles, the minor adjustment or repair of motor vehicles with hand tools only, ~~or the occasional washing of motor vehicles,~~ or electric vehicle charging are permitted #accessory uses#.

A #public parking lot# or #public parking garage# is not a permitted #accessory use#.

\* \* \*

**Energy infrastructure equipment**

“Energy infrastructure equipment” shall include renewable energy generation systems, such as solar or wind energy systems, and energy storage systems, such as fuel cells and batteries, which are essential throughout all districts in order to support the acceleration towards a distributed energy grid with electricity from fully renewable sources.

#Energy infrastructure equipment# shall refer to equipment that is a principal #use# on a #zoning lot#. Where such equipment is #accessory# to another #use#, it shall be considered #accessory# mechanical equipment.

Provisions pertaining to #energy infrastructure equipment# shall apply to all types of renewable energy generation systems, as well as to all types of energy storage systems, unless specific rules are otherwise specified, such as for solar and wind energy systems.

\* \* \*

**Floor area**

"Floor area" is the sum of the gross areas of the several floors of a #building# or #buildings#, measured from the exterior faces of exterior walls or from the center lines of walls separating two #buildings#. In particular, #floor area# includes:

\* \* \*

- (k) floor space that is ~~or becomes unused or~~ not otherwise exempt pursuant to this Section and is, or is made, inaccessible within a #building#;
- (l) ~~floor space that has been eliminated from the volume of an existing #building# in conjunction with the #development# of a new #building# or in the case of a major #enlargement#, as set forth in Section 11-31 (General Provisions), of another #building# on the same #zoning lot#;~~
- ~~(m) floor space used for mechanical equipment that exceeds 50 square feet for the first #dwelling unit#, an additional 30 square feet for the second #dwelling unit#, and an additional 10 square feet for each additional #dwelling unit# in R2X, R3, R4 or R5 Districts. For the purposes of calculating floor space used for mechanical equipment, #building segments# on a single #zoning lot# may be considered to be separate #buildings#;~~
- (~~m~~) (l) floor space in exterior balconies or in open or roofed terraces if more than 67 percent of the perimeter of such balcony or terrace is enclosed and provided that a parapet not higher than 3 feet, 8 inches, or a railing not less than 50 percent open and not higher than 4 feet, 6 inches, shall not constitute an enclosure. For the purposes of such calculation, exterior #building# walls on adjoining #zoning lots abutting# an open or roofed terrace shall not constitute an enclosure. A sun control device that is accessible for purposes other than for maintenance shall be considered a balcony; and
- (~~n~~) (m) any other floor space not specifically excluded.

However, the #floor area# of a #building# shall not include:

\* \* \*

[RELOCATING MECHANICAL EQUIPMENT DESCRIPTIONS TO ACCESSORY USE DEFINITION]

- (8) floor space used for #accessory# mechanical equipment, ~~including equipment serving the mechanical, electrical, or plumbing systems of #buildings# as well as fire protection systems, and power systems such as solar energy systems, generators, fuel cells, and energy storage systems.~~ Such exclusion shall also include the minimum necessary floor space to provide for necessary maintenance and access to such equipment. ~~However, such exclusion shall not apply in R2A Districts, and in R1-2A, R2X, R3, R4, or R5 Districts, such exclusion shall be limited to 50 square feet for the first #dwelling unit#, an additional 30 square feet for the second #dwelling unit# and an additional 10 square feet for each additional #dwelling unit#.~~ For the purposes of calculating floor space used for mechanical equipment, #building segments# on a single #zoning lot# may be considered to be separate #buildings#;

\* \* \*

- (12) #qualifying exterior wall thickness#, up to eight inches:
  - (i) where such wall thickness is added to the exterior face of a #building# wall existing on April 30, 2012, provided the added wall thickness has a thermal resistance (R-value) of at least 1.5 per inch; or
  - (ii) where such wall thickness is part of an exterior wall constructed after April 30, 2012, equal to the number of inches by which the wall's total thickness exceeds eight inches, provided the above-grade exterior walls of the #building# envelope are more energy efficient than required

by the New York City Energy Conservation Code (NYCECC) as determined by the following:

- (1) — the area-weighted average U-factor of all opaque above-grade wall assemblies shall be no greater than 80 percent of the area-weighted average U-factor determined by using the prescribed requirements of the NYCECC; and
- (2) — the area-weighted average U-factor of all above-grade exterior wall assemblies, including vertical fenestrations, shall be no more than 90 percent of the area-weighted average U-factor determined by using the prescribed requirements of the NYCECC. For the purposes of calculating the area-weighted average U-factor, the amount of fenestration shall equal the amount of fenestration provided in such exterior walls, or an amount equal to the maximum fenestration area referenced in the NYCECC for the calculation of the baseline energy code requirement, whichever is less;

For the purposes of calculating compliance with this paragraph, (12)(ii), the term “above-grade” shall only include those portions of walls located above the grade adjoining such wall. Compliance with this paragraph shall be demonstrated to the Department of Buildings at the time of issuance of the building permit for such exterior walls. The total area of wall thickness excluded from the calculation of #floor area# shall be reflected on the next issued temporary or final certificate of occupancy for the #building#, as well as all subsequent certificates of occupancy;

- (13) floor space in a #qualifying rooftop greenhouse# permitted pursuant to Sections 75-01 (Certification for Rooftop Greenhouses);
- (14) floor space on a sun control device, where such space is inaccessible other than for maintenance;
- (15) floor space within a #fully electrified building# or an #ultra low energy building#, of an amount equivalent to five percent of the #floor area# located within such #building#, and exclusive of any floor space otherwise excluded from #floor area#.

\* \* \*

**Front yard line level — see Yard line, front, level (of)**

**Fully electrified building**

A “fully electrified building” is a #building# existing on [date of adoption] which complies with the requirements of Local Law 154 of 2021, as such requirements would apply to a new #building# where an application for the approval of construction documents is submitted to the Commissioner of Buildings after July 1, 2027.

\* \* \*

**Private road**

A “private road” is a right-of-way, other than a #street#, that provides vehicular access from a #street# to five or more #dwelling units# that are within #buildings# or #building segments# that are located wholly beyond 50 feet of a #street line# or #street setback line#.

\* \* \*

Regulations for ~~#private roads#~~ are located in Sections 26-00 (APPLICABILITY OF THIS CHAPTER) and 37-10 (~~APPLICABILITY OF ARTICLE II, CHAPTER 6, TO LOTS WITH PRIVATE ROADS~~)-(SPECIAL REGULATIONS FOR PRIVATE ROADS AND LOWER DENSITY GROWTH MANAGEMENT AREAS).

\* \* \*

**Public parking garage**

A “public parking garage” is a ~~#building or other structure#~~:

- (a) that provides parking or storage for motor vehicles, but not for ~~commercial or public utility vehicles or~~ the dead storage of motor vehicles; and
- (b) some or all of whose parking spaces are non-~~#accessory#~~.

[MOVING TO PARKING CHAPTERS]

~~#Car sharing vehicles# may occupy parking spaces in a #public parking garage#; however, the number of spaces so occupied shall not exceed 40 percent of all parking spaces in such garage.~~ A #public parking garage# may include #accessory# off-street parking spaces limited to such spaces that are #accessory# to other #uses# on the same #zoning lot#.

~~Sale of motor fuel or motor oil or m~~Minor repairs incidental to the parking or storage of motor vehicles ~~are~~ is a permitted #accessory uses#.

**Public parking lot**

A “public parking lot” is any open area on a #zoning lot# that is:

- (a) used for the parking or storage of motor vehicles, but not for ~~commercial or public utility vehicles or~~ the dead storage of motor vehicles; and
- (b) not #accessory# to a #use# on the same or another #zoning lot#.

[MOVING TO PARKING CHAPTERS]

~~#Car sharing vehicles# may occupy spaces in a #public parking lot#; however, the number of spaces so occupied shall not exceed 40 percent of all parking spaces in such parking lot.~~ Minor repairs incidental to the parking or storage of motor vehicles are a permitted #accessory use#.

\* \* \*

**Publicly accessible open area**

A “publicly accessible open area” is an open area for public use on a #zoning lot developed# in accordance with the requirements of a #plaza#, #residential plaza#, #urban plaza# or #public plaza#.

**Qualifying exterior wall thickness**

“Qualifying exterior wall thickness” shall refer to the floor space occupied by exterior wall thickness added to a #building# existing on [date of adoption], where:

- (a) for over-cladding projects: such wall thickness is added to a wall existing on [date of adoption], up to a maximum of 12 inches, provided the added wall thickness has an aggregate thermal resistance (R-value) of at least 1.5 per inch; or
- (b) for re-cladding projects: such wall thickness is located within a new wall that replaces a wall existing on [date of adoption], where the qualifying portion is occupied by additional thickness relative to the previous wall, up to a maximum of 12 additional inches, and provided that the new wall shall comply with the minimum prescriptive and mandatory requirements for building thermal envelopes of the current New York City Energy Conservation Code.

#Qualifying exterior wall thickness# shall also include exterior wall thickness in exterior walls constructed between April 30, 2012 and [date of adoption] where such exterior wall thickness satisfied the requirements of paragraph (12)(ii) of the definition of #floor area# in effect at the time of construction.

#Qualifying exterior wall thickness# need not exclusively contain insulating materials and may include wall thickness occupied by conduits, ductwork, pipes, or other essential non-insulating building components.

**Qualifying ground floor**

A “qualifying ground floor” shall refer to the ground floor of a #development# or #enlargement# of a #Quality Housing building# on a #zoning lot#, or portion thereof, where:

\* \* \*

**Qualifying rooftop greenhouse**

A “qualifying rooftop greenhouse” shall refer to any rooftop greenhouse that:

- (a) is located on the roof of a #building# that does not contain #residences#;
- (b) will be used primarily for cultivation of plants; and
- (c) has roofs and walls consisting of at least 70 percent transparent materials.

Such qualifying rooftop greenhouses shall be exempt from the definition of #floor area#, and shall be considered a permitted obstruction to height and setback, as set forth in the applicable district regulations.

Rooftop greenhouses which do not meet the requirements of this definition may also be permitted pursuant to the underlying district regulations, but shall not be exempt from the definition of #floor area#, and shall not be permitted obstructions to height and setback.

\* \* \*

**Ultra low energy building**



An “ultra-low-energy building” shall refer to a #building# which complies with requirements for ultra-low-energy usage. At time of application for plan approval to the Commissioner of Buildings, materials shall be submitted demonstrating:

(a) that such #building# shall comply with the requirements of Local Law 154 of 2021, as such requirements would apply to a new #building# where an application for the approval of construction documents is submitted to the Commissioner of Buildings after July 1, 2027;

(b) that such #building# shall be designed and constructed to reduce energy use:

(1) for #buildings# three #stories# or less:

such #building# shall be a net-zero energy #building# which shall produce energy onsite from renewable energy sources in an amount equal to or greater than such #building#'s total energy needs; or

(2) for all other #buildings#:

~~a site energy use intensity energy performance that is exceeds by at least 15 percent or more below the site energy use intensity energy performance of such a #building# if designed and constructed according to an approved modeling method set forth in ASHRAE 90.1 required by the New York City Energy Conservation Code.~~

(c) ~~that the proposed design has been analyzed using an energy model or alternative design analysis, and that a registered design professional has verified that the proposed design will meet the requirements of this definition; and~~

(d) that plans have been prepared to conduct, as relevant: inspections, equipment commissioning, and airtightness testing during the construction phase.

No final certificate of occupancy shall be issued for such a #building# until a report prepared by a registered design professional has been submitted to the Commissioner of Buildings verifying that the #building# has completed and successfully passed the inspections, commissioning, and testing set forth in paragraph (d) of this definition.

The Department of City Planning may, by rule, update or supplement the requirements of this section exclusively for the purpose of keeping such requirements aligned with advancing technological and construction practices. Such updates may only modify the statutory reference in paragraph (a) of this definition; the specified parameters and reference standards of paragraph (b)(2) of this definition.

\* \* \*

**Chapter 3  
Comprehensive Off-street Parking and Loading Regulations in the Manhattan Core**

**13-00  
GENERAL PURPOSES**

\* \* \*

**13-02**

**Definitions**

\* \* \*

[MOVING TO SECTION 12-10]

~~Automated parking facility~~

~~For the purposes of this Chapter, an “automated parking facility” shall refer to an #accessory# off street parking facility or #public parking garage# where vehicular storage and retrieval within such facility is accomplished entirely through a mechanical conveyance system. A parking facility with parking lift systems that require an attendant to maneuver a vehicle that is to be parked shall not be considered an #automated parking facility#.~~

\* \* \*

**13-10**

**PERMITTED OFF-STREET PARKING IN THE MANHATTAN CORE**

\* \* \*

[NOW COVERED BY UNDERLYING RULES]

**13-101**

**Calculating parking spaces in automated parking facilities**

~~For the purposes of this Resolution, with regard to #automated parking facilities#, the term “tray” shall refer to the structural support for vehicle storage in both pallet and non pallet vehicle storage systems.~~

~~For the purpose of calculating parking spaces in #automated parking facilities#, each tray upon which a vehicle is stored shall constitute one off street parking space. However, auxiliary parking trays may be exempted from constituting a parking space where the Commissioner of Buildings determines that such auxiliary parking trays are necessary to store and retrieve vehicles for the efficient operation of such #automated parking facility#.~~

\* \* \*

[NOW COVERED BY UNDERLYING RULES]

**13-16**

**Permitted Parking for Car Sharing Vehicles and Commercial Vehicles**

~~#Car sharing vehicles# and commercial vehicle parking for motor vehicles not exceeding a length of 20 feet shall be permitted within #accessory# off street parking facilities, #public parking garages# and #public parking lots#, as follows:~~

(a) ~~#Accessory# off street parking facilities~~

~~#Car sharing vehicles# may occupy parking spaces in an #accessory# off street parking facility, provided that such #car sharing vehicles# shall not exceed 20 percent of all parking spaces in such facility, or five spaces, whichever is greater;~~

(b) ~~#Public parking garages# and #public parking lots#~~

~~(1) In C1-5, C1-6, C1-7, C1-8, C1-9, C2 and C4 Districts, vehicles stored by automobile rental establishments and #car sharing vehicles# shall be permitted, provided such vehicles do not exceed, in total, 40 percent of the total number of parking spaces permitted within the #public parking garage# or #public parking lot#;~~

~~(2) In C5, C6, C8, M1, M2 and M3 Districts, vehicles stored by automobile rental establishments and #car sharing vehicles# shall be permitted, provided such vehicles do not exceed, in total, 40 percent of the total number of parking spaces permitted within the #public parking garage# or #public parking lot#. In addition, commercial vehicle parking for motor vehicles not exceeding a length of 20 feet shall be permitted, provided that the total amount of parking spaces occupied by commercial vehicles, including any #car sharing vehicles# and automobile rental establishment vehicles, shall not exceed, in total, 50 percent of the total number of parking spaces permitted within the #public parking garage# or #public parking lot#.~~

\* \* \*

**13-20  
SPECIAL RULES FOR MANHATTAN CORE PARKING FACILITIES**

\* \* \*

**13-23  
Floor Area**

The definition of #floor area# in Section 12-10 shall be modified for purposes of this Chapter, as follows:

[NOW COVERED BY UNDERLYING RULES]

~~(a) Attended parking facilities with parking lift systems~~

~~For portions of an attended parking facility with parking lift systems, individual lifted trays upon which a vehicle is stored which, in operation, rise to a height in excess of 23 feet, as measured above #curb level#, shall be considered #floor area# in an amount of 153 square feet, or the size of such lifted tray, whichever is greater.~~

~~(b) #Automated parking facilities#~~

~~Floor space used for off-street parking spaces in an #accessory# #automated parking facility# up to a height of 40 feet above #curb level# shall be exempt from the definition of #floor area# upon certification of the Chairperson of the City Planning Commission, pursuant to the provisions of Section 13-432 (Floor area exemption for automated parking facilities).~~

[NOW COVERED BY UNDERLYING RULES]

~~For portions of an #automated parking facility#, each tray upon which a vehicle is stored at a height in excess of 40 feet in parking facilities certified pursuant to Section 13-432, or 23 feet in all other #automated parking facilities#, shall be considered #floor area# in an amount of 153 square feet, or the size of such lifted tray, whichever is greater.~~

\* \* \*

**Chapter 6  
Comprehensive Off-Street Parking Regulations in the Long Island City Area**

\* \* \*

**16-10  
PERMITTED OFF-STREET PARKING IN THE LONG ISLAND CITY AREA**

\* \* \*

[NOW COVERED BY UNDERLYING RULES]

**16-16  
~~Permitted Parking for Car Sharing Vehicles and Commercial Vehicles~~**

~~#Car sharing vehicles# and commercial vehicle parking for motor vehicles not exceeding a length of 20 feet shall be permitted, as follows:~~

~~(a) — #Accessory# off street parking facilities~~

~~#Car sharing vehicles# may occupy parking spaces in an #accessory# off street parking facility, provided that such #car sharing vehicles# shall not exceed 20 percent of all parking spaces in such facility, or five spaces, whichever is greater. #Accessory# #residential# off street parking spaces shall be made available to the occupant of a #residence# to which it is #accessory# within 30 days after a written request therefor is made to the landlord.~~

~~(b) — #Public parking garages# and #public parking lots#~~

~~(1) — #Car sharing vehicles# shall be permitted within #public parking garages# and, where authorized pursuant to Section 16-342, #public parking lots#, provided such vehicles do not exceed, in total, 40 percent of the total number of parking spaces permitted.~~

~~(2) — Commercial vehicle parking for motor vehicles not exceeding a length of 20 feet shall be permitted within #public parking garages# and, where authorized pursuant to Section 16-342, #public parking lots#, provided that the total amount of parking spaces occupied by commercial vehicles shall not exceed 10 percent of the total number of parking spaces permitted, or 10 spaces, whichever is less.~~

\* \* \*

**ARTICLE II  
RESIDENCE DISTRICT REGULATIONS**

\* \* \*

**Chapter 2  
USE REGULATIONS**

\* \* \*

**22-14  
Use Group 4**

R1 R2 R3 R4 R5 R6 R7 R8 R9 R10

Use Group 4 consists primarily of community facilities that:

- (1) may appropriately be located in #residential# areas to provide recreational, religious, health and other essential services for the residents; or
- (2) can perform their activities more effectively in a #residential# environment, unaffected by objectionable influences from adjacent medium and heavy industrial #uses#; and
- (3) do not create significant objectionable influences in #residential# areas.

Those open #uses# of land which are compatible with a #residential# environment are also included.

\* \* \*

B. Open #uses#

\* \* \*

C. Special infrastructure

#Energy infrastructure equipment#, open or enclosed, provided that the total #lot area# occupied by such equipment does not exceed 10,000 square feet. Where multiple pieces of equipment are provided, the aggregate footprint of all such equipment shall not exceed 10,000 square feet. All #energy infrastructure equipment# shall be subject to the provisions of Section 26-60 (SPECIAL SCREENING AND ENCLOSURE PROVISIONS)

~~C. D. #Accessory# #uses#~~

\* \* \*

**Chapter 3  
Residential Bulk Regulations in Residence Districts**

**23-00  
APPLICABILITY AND GENERAL PURPOSES**

\* \* \*

**23-012  
Lower density growth management areas**

For areas designated as #lower density growth management areas# pursuant to Section 12-10 (DEFINITIONS), the underlying district regulations shall apply. Such regulations are superseded or supplemented as set forth in the following Sections:

\* \* \*

Section 37-10 ~~(APPLICABILITY OF ARTICLE II, CHAPTER 6, TO LOTS WITH PRIVATE ROADS)~~  
(SPECIAL REGULATIONS FOR PRIVATE ROADS AND LOWER DENSITY GROWTH MANAGEMENT AREAS)

~~Section 37-20 (SPECIAL REGULATIONS FOR LOWER DENSITY GROWTH MANAGEMENT AREAS IN THE BOROUGH OF STATEN ISLAND), inclusive~~

**23-10  
OPEN SPACE AND FLOOR AREA REGULATIONS**

\* \* \*

**23-12  
Permitted Obstructions in Open Space**

R1 R2 R3 R4 R5 R6 R7 R8 R9 R10

In the districts indicated, the obstructions permitted for any #yard# set forth in paragraph (a) of Section 23-441 (General permitted obstruction allowances), as well as the following obstructions, shall be permitted in any #open space# required on a #zoning lot#. For the purposes of applying such allowances to #open space#, all percentage calculations shall be applied to the area of the #open space# instead of the #yard# :

- ~~(a)~~ Air conditioning condensation units, #accessory#, for #single # or #two-family# #residences#, provided that such units, if located between a #street wall#, or prolongation thereof, and a #street line#, are not more than 18 inches from a #street wall#, and fully screened from the #street# by vegetation;
- ~~(b)~~ Awnings and other sun control devices. However, when located at a level higher than the first #story#, excluding a #basement#, all such devices:
  - ~~(1)~~ shall be limited to a maximum projection from a #building# wall of 2 feet, 6 inches; and
  - ~~(2)~~ shall have solid surfaces that, in aggregate, cover an area no more than 30 percent of the area of the #building# wall (as viewed in elevation) from which they project;
- ~~(c)~~ (a) Balconies, unenclosed, subject to the provisions of Section 23-13;
- ~~(d)~~ (b) Breezeways;
- ~~(e)~~ (c) Driveways, private streets, open #accessory# off-street parking spaces, unenclosed #accessory# bicycle parking spaces or open #accessory# off-street loading berths, provided that the total area occupied by all these items does not exceed the percentages set forth in Section 25-64 (Restrictions on Use of Open Space for Parking);

- ~~(f) Eaves, gutters or downspouts, projecting into such #open space# not more than 16 inches or 20 percent of the width of such #open space#, whichever is the lesser distance;~~
- ~~(g) Exterior wall thickness, where such wall thickness is added to the exterior face of a #building# wall existing on April 30, 2012, provided the added wall thickness has a thermal resistance (R value) of at least 1.5 per inch, and is limited to one inch of thickness for every foot of existing #open space# width, up to a maximum thickness of eight inches;~~
- (d) #Energy infrastructure equipment# and #accessory# mechanical equipment, subject to the requirements set forth in Section 23-442;
- (e) Greenhouses, non-commercial, #accessory#, limited to one #story# or 15 feet in height above adjoining grade, whichever is less, and limited to an area not exceeding 25 percent of the #open space##;
- ~~(h)(f) Parking spaces, off-street, enclosed, #accessory#, not to exceed one space per #dwelling unit#, when #accessory# to a #single-family#, #two-family# or three-#family# #residence#, provided that the total area occupied by a #building# used for such purposes does not exceed 20 percent of the total required #open space# on the #zoning lot#. However, two such spaces for a #single-family# #residence# may be permitted in #lower density growth management areas# and in R1-2A Districts;~~
- ~~(i) #Accessory# power systems, including, but not limited to, generators, solar energy systems, fuel cells, batteries and other energy storage systems, provided that:~~
- ~~(1) all equipment shall be subject to the following location, enclosure, and screening requirements, as applicable:~~
- ~~(i) all generators and cogeneration equipment #accessory# to #buildings# other than #single # or #two family# #residences# shall be completely enclosed within a #building or other structure#, except as necessary for mechanical ventilation;~~
- ~~(ii) all other types of equipment, including generators and cogeneration equipment serving #single # or #two family# #residences#, may be unenclosed, provided that such equipment is located at least five feet from any #lot line#. However, if the area bounding all such equipment, as drawn by a rectangle from its outermost perimeter in plan view, exceeds 25 square feet, such equipment shall be screened in its entirety on all sides. Such screening may be opaque or perforated, provided that where perforated materials are provided, not more than 50 percent of the face is open;~~
- ~~(iii) where any equipment is located between a #street wall#, or prolongation thereof, and a #street line#, the entire width of such portion of the equipment facing a #street#, whether open or enclosed, shall be fully screened by vegetation; and~~
- ~~(2) the size of all equipment, including any screening or portions of any #building or other structure# enclosing such equipment, shall not exceed:~~
- ~~(i) an area equivalent to 25 percent of a required #open space#;~~
- ~~(ii) in R1 through R5 Districts, a height of 10 feet above the adjoining grade; and~~
- ~~(iii) in R6 through R10 Districts, a height of 15 feet above the adjoining grade.~~
- ~~(j) Ramps or lifts for people with physical disabilities;~~

~~(k)~~(g) Solar energy systems:

- (1) on the roof of an #accessory# #building#, limited to 18 inches in height as measured perpendicular to the roof surface; or
- ~~(2)~~ affixed to solar canopies and located over any #accessory# off-street parking space, provided that the height shall not exceed 15 feet above the level of the adjoining grade;
- ~~(2)~~ on walls existing on April 30, 2012, projecting no more than 10 inches and occupying no more than 20 percent of the surface area of the #building# wall (as viewed in elevation) from which it projects;

(h) Steps;

~~(i)~~(i) Swimming pools, #accessory#, above-grade structures limited to a height not exceeding eight feet above the level of the #rear yard# or #rear yard equivalent#;

~~(m)~~(j) Terraces, ~~unenclosed~~, fire escapes or planting boxes, provided that no such items project more than six feet into or over such #open space#.

However, any such #open space# that is part of a required #yard#, #rear yard equivalent# or #court# may contain an obstruction listed in this Section only where such obstruction is permitted, pursuant to Sections 23-44 (Permitted Obstructions in Required Yards or Rear Yard Equivalents) or 23-87 (Permitted Obstructions in Courts), as applicable.

\* \* \*

**23-142**

**Open space and floor area regulations in R1 and R2 Districts with a letter suffix and R3 through R5 Districts**

R1 R2 R3 R4 R5

In R1 and R2 Districts with a letter suffix and R3 through R5 Districts, the maximum #lot coverage#, minimum #open space# and maximum #floor area ratio# shall be as set forth in the following table:

\* \* \*

In addition, the following rules shall apply:

- (c) In R3, R4 and R5 Districts, the permitted #floor area# of a #single-# or #two-family# #detached# or #semi-detached# #residence# #developed# after June 30, 1989, may be increased by up to 300 square feet if at least one enclosed #accessory# off-street parking space is provided in a garage located, wholly or partly, in the #side lot ribbon# pursuant to Sections 23-12 (Permitted Obstructions in Open Space), paragraph ~~(e)~~ (c), 23-4413 (Location of garages in side yards of corner lots) or 23-4424 (Location of garages in side yards of other zoning lots).
- (d) In R1-2A Districts and in R3, R4-1 and R4A Districts within #lower density growth management areas#, the permitted #floor area# of a #single-# or #two-family# #detached# or #semi-detached# #residence# may be increased by up to 300 square feet for one parking space and up to 500 square feet for two parking spaces provided such spaces are in a garage located, wholly or partly, in the #side lot ribbon# pursuant to Sections 23-12, paragraph (e), 23-4413 or 23-4424, except that in R1-2A Districts, such parking spaces need not be located in the #side lot ribbon#.

\* \* \*



**23-40  
YARD REGULATIONS**

\* \* \*

**23-44  
Permitted Obstructions in Required Yards or Rear Yard Equivalents**

In all #Residence Districts#, the ~~following~~ obstructions set forth in this Section, inclusive, shall be permitted within a required #yard# or #rear yard equivalent# .:

[EXISTING OBSTRUCTIONS TO BE MOVED TO SUBSECTIONS]

- (a) In any #yard# or #rear yard equivalent# :
- (1) ~~Air conditioning condensation units, #accessory#, for #single # or #two family# #residences#, provided that such units, if located between a #street wall#, or prolongation thereof, and a #street line#, are not more than 18 inches from a #street wall#, and fully screened from the #street# by vegetation;~~
  - (2) ~~Arbors or trellises;~~
  - (3) ~~Awnings and other sun control devices, provided that when located at a level higher than the first #story#, excluding a #basement#, all such awnings and other sun control devices:~~
    - (i) ~~shall be limited to a maximum projection from a #building# wall of 2 feet, 6 inches; and~~
    - (ii) ~~shall have solid surfaces that, in aggregate, cover an area no more than 30 percent of the area of the #building# wall (as viewed in elevation) from which they project;~~
  - (4) ~~Balconies, unenclosed, of a #building# containing #residences# subject to the applicable provisions of Section 23-13. Such balconies are not permitted in required #side yards#;~~
  - (5) ~~Canopies;~~
  - (6) ~~Chimneys, projecting not more than three feet into, and not exceeding two percent of the area of, the required #yard# or #rear yard equivalent#;~~
  - (7) ~~Eaves, gutters or downspouts projecting into such #yard# or #rear yard equivalent# not more than 16 inches or 20 percent of the width of such #yard# or #rear yard equivalent#, whichever is the lesser distance;~~
  - (8) ~~Exterior wall thickness, where such wall thickness is added to the exterior face of a #building# wall existing on April 30, 2012, provided the added wall thickness has a thermal resistance (R-value) of at least 1.5 per inch, and is limited to one inch of thickness for every foot of existing #yard# width, up to a maximum thickness of eight inches. When an open area is provided along a common #lot line#, then such exterior wall thickness is limited to one inch for every foot of existing open area on the #zoning lot#;~~

Where #buildings# that have added exterior wall thickness, pursuant to this Section, are #enlarged#, such #enlarged# portion may similarly encroach upon required #yards# in order to align with the exterior walls of the existing #building#, provided such #enlargement# contains less #floor area# than the existing #building#, and there is no encroachment of #floor area# into a required #yard#;

- (9) — Fences, not exceeding four feet in height above adjoining grade in any #front yard#, except that for #corner lots# a fence may be up to six feet in height within that portion of one #front yard# that is between a #side lot line# and the prolongation of the side wall of the #residence# facing such #side lot line#;
- (10) — Fire escapes, projecting into a #front yard#, only in such cases where the fire escape is required for the #conversion# of a #building# in existence before December 15, 1961;
- (11) — Flagpoles;
- (12) — Overhanging portions of a #building# in R4 and R5 Districts, except R4-1, R4A, R4B, R5A, R5B or R5D Districts, which are above the first #story# including the #basement# and which project not more than three feet into the required 18-foot #front yard#. In no case shall the lowest level of the projected portion be less than seven feet above the level of the #front yard# at the face of the #building#. Supports for the projected portion of any #building# are permitted obstructions within the required #front yard#, provided that the total area occupied by such supports does not exceed 15 percent of the area underneath the projected portion. No support may extend beyond the three-foot projection;
- (13) — Parking spaces for automobiles or bicycles, off-street, open, #accessory#, within a #side# or #rear yard#;
- (14) — Parking spaces, off-street, open, within a #front yard#, that are #accessory# to a #building# containing #residences#, provided that:
  - (i) — in R1, R2, R3-1, R3A, R3X, R4-1, R4A and R5A Districts, except in #lower density growth management areas#, such spaces meet all the requirements of paragraph (a) of Section 25-621 (Location of parking spaces in certain districts);
  - (ii) — in R3-2 Districts, R4 Districts other than R4-1, R4A and R4B Districts, and R5 Districts other than R5A, R5B and R5D Districts, such spaces meet all the requirements of paragraph (b) of Section 25-621;
  - (iii) — in #lower density growth management areas#, such spaces are non-required and are located in a driveway that accesses parking spaces that are located behind the #street wall# of the #building# or prolongation thereof;

However, no parking spaces of any kind shall be permitted in any #front yard# in an R4B, R5B or R5D District. Furthermore, no parking spaces of any kind shall be permitted in any #front yard# on a #zoning lot# containing an #attached# or #semi-detached# #building# in an R1, R2, R3A, R3X, R4A or R5A District, or in any #front yard# on a #zoning lot# containing an #attached# #building# in an R3-1 or R4-1 District;

- (15) — #Accessory# power systems, including, but not limited to, generators, solar energy systems, fuel cells, batteries and other energy storage systems, provided that:

- (i) ~~all equipment shall be subject to the following location, enclosure, and screening requirements, as applicable:~~
  - (a) ~~all generators and cogeneration equipment #accessory# to #buildings# other than #single # or #two family# #residences# shall be completely enclosed within a #building or other structure#, except as necessary for mechanical ventilation;~~
  - (b) ~~all other types of equipment, including generators and cogeneration equipment serving #single # or #two family# #residences#, may be unenclosed, provided that such equipment is located at least five feet from any #lot line#. However, if the area bounding all such equipment, as drawn by a rectangle from its outermost perimeter in plan view, exceeds 25 square feet, such equipment shall be screened in its entirety on all sides. Such screening may be opaque or perforated, provided that where perforated materials are provided, not more than 50 percent of the face is open;~~
  - (c) ~~where any equipment is located in a #front yard#, the entire width of such portion of such equipment facing a #street#, whether open or enclosed, shall be fully screened by vegetation; and~~
- (ii) ~~the size of all equipment, including any screening or portions of any #building or other structure# enclosing such equipment, shall not exceed:~~
  - (a) ~~an area equivalent to 25 percent of a required #yard#, or #rear yard equivalent#, and in addition, in #front yards#, is limited to an area not exceeding 25 square feet. However, for #corner lots#, one #front yard# may be treated as a #side yard# for the purpose of applying such size restrictions;~~
  - (b) ~~in R1 through R5 Districts, a height of 10 feet above the adjoining grade in #rear yards#, #rear yard equivalents# and #side yards#, or a height of five feet above the adjoining grade in #front yards#; and~~
  - (c) ~~in R6 through R10 Districts, a height of 15 feet above the adjoining grade;~~
- (16) ~~Ramps or lifts for people with physical disabilities;~~
- (17) ~~Solar energy systems on walls existing on April 30, 2012, projecting no more than 10 inches and occupying no more than 20 percent of the surface area of the #building# wall (as viewed in elevation) from which it projects;~~
- (18) ~~Steps, provided that such steps access only the lowest #story# or #cellar# of a #building# fronting on a #street#, which may include a #story# located directly above a #basement#;~~
- (19) ~~Swimming pools, #accessory#, above grade structures limited to a height not exceeding eight feet above the level of the #rear yard# or #rear yard equivalent#. #Accessory# swimming pools are not permitted obstructions in any #front yard#;~~
- (20) ~~Terraces or porches, open;~~
- (21) ~~Walls, not exceeding eight feet in height above adjoining grade and not roofed or part of a #building#, and not exceeding four feet in height in any #front yard#, except that for #corner lots#, a wall may be up to six feet in height within that portion of one #front yard# that is~~

between a #side lot line# and the prolongation of the side wall of the #residence# facing such #side lot line#;

- (b) In any #rear yard# or #rear yard equivalent#:
- (1) — Balconies, unenclosed, subject to the provisions of Section 23-13;
  - (2) — Breezeways;
  - (3) — Fire escapes;
  - (4) — Greenhouses, non-commercial, #accessory#, limited to one #story# or 15 feet in height above adjoining grade, whichever is less, and limited to an area not exceeding 25 percent of a required #rear yard#;
  - (5) — Parking spaces, off-street, #accessory#, for automobiles or bicycles, provided that:
    - (i) — if #accessory# to a #single # or #two-family residence#, the height of a #building# containing such parking spaces shall not exceed 10 feet in height above the adjoining grade and such #building# shall be #detached# from such #residence#. Furthermore, if located in an R1 District, such #building# may not be nearer than five feet to a #rear lot line# or #side lot line#. In R2A Districts, detached garages shall be included in #lot coverage#. In addition, solar energy systems, limited to 18 inches in height, as measured perpendicular to the roof surface, shall be permitted upon the roof of such #accessory# #building# within the #rear yard#;
    - (ii) — if #accessory# to any other kind of #building# containing #residences#, the height of a #building#, or portion thereof, containing such parking spaces within the #rear yard#, shall not exceed 10 feet above adjoining grade, including the apex of a pitched roof in R3, R4 or R5 Districts, or 15 feet above #curb level# or #base plane#, as applicable, in R6, R7, R8, R9 or R10 Districts. In addition, decks, parapet walls, roof thickness, skylights, vegetated roofs, and weirs, as set forth in Section 23-62 (Permitted Obstructions), and solar energy systems, limited to 18 inches in height, as measured perpendicular to the roof surface, shall be permitted upon the roof of such #accessory# #building# within the #rear yard#;
    - (iii) — enclosed #accessory# parking spaces for bicycles shall be #accessory# to a #residence# other than a #single # or #two-family residence#, attached to a #building#, and the area dedicated to such spaces shall not exceed the area of bicycle parking spaces permitted to be excluded from #floor area# pursuant to Section 25-85 (Floor Area Exemption);
  - (6) — Recreational or drying yard equipment;
  - (7) — Sheds, tool rooms or other similar #accessory# #buildings# or other structures# for domestic or agricultural storage, with a height not exceeding 10 feet above the level of the #rear yard# or #rear yard equivalent#;
  - (8) — Water-conserving devices required in connection with air conditioning or refrigeration systems in #buildings# existing prior to May 20, 1966, if located not less than eight feet from any #lot line#.

- (9) ~~any portion of a #building# used for #residential uses# other than #dwelling units# in #Quality Housing buildings# containing #affordable independent residences for seniors# on #zoning lots# meeting the criteria set forth in paragraph (a)(4) of Section 23-664 (Modified height and setback regulations for certain Inclusionary Housing buildings or affordable independent residences for seniors), provided that:~~
- ~~(i) such #zoning lot# is located in an R6 through R10 District other than an R6B, R7B or R8B District;~~
  - ~~(ii) the height of such #building# portion does not exceed one #story#, or 15 feet above the adjoining grade, whichever is less;~~
  - ~~(iii) such #building# portion is located within 100 feet of a #wide street#; and~~
  - ~~(iv) such space shall be accessible to all residents of the #building#.~~

~~In addition, decks, parapet walls, roof thickness, skylights, vegetated roofs and weirs, as set forth in Section 23-62 (Permitted Obstructions), and solar energy systems, limited to 18 inches in height, as measured perpendicular to the roof surface, shall be permitted upon the roof of such portion of a #building# within the #rear yard#.~~

~~However, no portion of a #rear yard equivalent# which is also a required #front yard# or required #side yard# may contain any obstructions not permitted in such #front yard# or #side yard#.~~

## **23-441**

### **General permitted obstruction allowances**

In all #Residence Districts#, the following obstructions shall be permitted within any required #yard# or #rear yard equivalent#. These allowances are generally common to #Residence#, #Commercial# and #Manufacturing Districts#.

- (a) In any #yard# or #rear yard equivalent# :
- (1) #Accessory# mechanical equipment, limited in depth to 18 inches from an exterior wall;
  - (2) Arbors or trellises;
  - (2) Awnings and other sun control devices, provided that when located at a level higher than the first #story#, excluding a #basement#, all such awnings and other sun control devices:
    - (i) shall be limited to a maximum projection from a #building# wall of 2 feet, 6 inches; and
    - (ii) shall have solid surfaces that, in aggregate, cover an area no more than 30 percent of the area of the #building# wall (as viewed in elevation) from which they project;
  - (3) Bicycles or micromobility parking, including necessary ancillary structures
  - (4) Canopies;
  - (5) Chimneys, projecting not more than three feet into, and not exceeding two percent of the area of, the required #yard# or #rear yard equivalent#;

- (6) Eaves, gutters, downspouts, or other similar projections, extending into such #yard# or #rear yard equivalent# not more than 16 inches or 20 percent of the width of such #yard# or #rear yard equivalent#, whichever is the lesser distance;
  - (7) Electric vehicle charging equipment;
  - (8) Flagpoles;
  - (9) #Qualifying exterior wall thickness#;
  - (10) Ramps or lifts for people with physical disabilities;
  - (11) Solar energy systems, #accessory# or as part of an #energy infrastructure equipment#:
    - (i) on walls existing on April 30, 2012, projecting no more than 10 inches and occupying no more than 20 percent of the surface area of the #building# wall (as viewed in elevation) from which it projects; or
    - (ii) above other permitted obstructions, as applicable, provided that the additional height shall be limited to 18 inches;
  - (12) Terraces or porches, open;
  - (13) Window sills, or similar projections extending into such #yard# or #rear yard equivalent# not more than four inches;
- (b) In any #rear yard# or #rear yard equivalent#:
- (1) Breezeways;
  - (2) Fire escapes;
  - (3) Greenhouses, non-commercial, #accessory#, limited to one #story# or 15 feet in height above adjoining grade, whichever is less, and limited to an area not exceeding 25 percent of a required #rear yard#;
  - (4) Recreational or drying yard equipment;
  - (5) Sheds, tool rooms or other similar #accessory# #buildings or other structures# for domestic or agricultural storage, with a height not exceeding 10 feet above the level of the #rear yard# or #rear yard equivalent#;
  - (6) Solar energy systems, #accessory# or as part of an #energy infrastructure equipment#:
    - (i) on the roof of a #building# permitted as an obstruction to such #yard#, up to four feet in height as measured perpendicular to the roof surface; however, limited to 18 inches in height as measured perpendicular to the roof surface when located above a detached #accessory# #building or other structure#, or on any roof with a slope greater than 20 degrees; or
    - (ii) affixed to solar canopies and located over any #accessory# off-street parking space, provided that the height shall not exceed 15 feet above the level of the adjoining grade;

- (7) Water-conserving devices required in connection with air conditioning or refrigeration systems in #buildings# existing prior to May 20, 1966, if located not less than eight feet from any #lot line#.

However, no portion of a #rear yard equivalent# which is also a required #front yard# or required #side yard# may contain any obstructions not permitted in such #front yard# or #side yard#.

### **23-442**

#### **Additional permitted obstructions**

In all #Residence Districts#, the obstructions set forth in Section 23-441 (General permitted obstruction allowances), as well as the following obstructions, shall be permitted within a required #yard# or #rear yard equivalent#:

[MOVING PROVISIONS ONLY TO APPLICABLE TO RES TO SPECIFIC SUBSECTIONS]

- (a) In any #yard# or #rear yard equivalent# :
- (1) Balconies, unenclosed, of a #building# containing #residences# subject to the applicable provisions of Section 23-13. Such balconies are not permitted in required #side yards#;
  - (2) Fences, not exceeding four feet in height above adjoining grade in any #front yard#, except that for #corner lots# a fence may be up to six feet in height within that portion of one #front yard# that is between a #side lot line# and the prolongation of the side wall of the #residence# facing such #side lot line#;
  - (3) Fire escapes, projecting into a #front yard#, only in such cases where the fire escape is required for the #conversion# of a #building# in existence before December 15, 1961;
  - (4) Overhanging portions of a #building# in R4 and R5 Districts, except R4-1, R4A, R4B, R5A, R5B or R5D Districts, which are above the first #story# including the #basement# and which project not more than three feet into the required 18-foot #front yard#. In no case shall the lowest level of the projected portion be less than seven feet above the level of the #front yard# at the face of the #building#. Supports for the projected portion of any #building# are permitted obstructions within the required #front yard#, provided that the total area occupied by such supports does not exceed 15 percent of the area underneath the projected portion. No support may extend beyond the three-foot projection;
  - (5) Parking spaces for automobiles, off-street, open, #accessory#, within a #side# or #rear yard#;
  - (6) Parking spaces, off-street, open, within a #front yard#, that are #accessory# to a #building# containing #residences#, provided that:
    - (i) in R1, R2, R3-1, R3A, R3X, R4-1, R4A and R5A Districts, except in #lower density growth management areas#, such spaces meet all the requirements of paragraph (a) of Section 25-621 (Location of parking spaces in certain districts);

- (ii) in R3-2 Districts, R4 Districts other than R4-1, R4A and R4B Districts, and R5 Districts other than R5A, R5B and R5D Districts, such spaces meet all the requirements of paragraph (b) of Section 25-621;
- (iii) in #lower density growth management areas#, such spaces are non-required and are located in a driveway that accesses parking spaces that are located behind the #street wall# of the #building# or prolongation thereof;

However, no parking spaces of any kind shall be permitted in any #front yard# in an R4B, R5B or R5D District. Furthermore, no parking spaces of any kind shall be permitted in any #front yard# on a #zoning lot# containing an #attached# or #semi-detached# #building# in an R1, R2, R3A, R3X, R4A or R5A District, or in any #front yard# on a #zoning lot# containing an #attached# #building# in an R3-1 or R4-1 District;

- (7) #Energy infrastructure equipment# and #accessory# mechanical equipment, provided that:
    - (i) all equipment shall be subject to the applicable provisions of Section 26-60 (SPECIAL SCREENING AND ENCLOSURE PROVISIONS);
    - (ii) the size of all equipment, including any screening or portions of any #building or other structure# enclosing such equipment, shall not exceed:
      - (a) an area equivalent to 25 percent of a required #yard#, or #rear yard equivalent#, and in addition, in #front yards#, is limited to an area not exceeding 25 square feet. However, for #corner lots#, one #front yard# may be treated as a #side yard# for the purpose of applying such size restrictions;
      - (b) in R1 through R5 Districts, a height of 10 feet above the adjoining grade in #rear yards#, #rear yard equivalents# and #side yards#, or a height of five feet above the adjoining grade in #front yards#; and
      - (c) in R6 through R10 Districts, a height of 15 feet above the adjoining grade;
  - (8) Steps, provided that such steps access only the lowest #story# or #cellar# of a #building# fronting on a #street#, which may include a #story# located directly above a #basement#;
  - (9) Swimming pools, #accessory#, above-grade structures limited to a height not exceeding eight feet above the level of the #rear yard# or #rear yard equivalent#. #Accessory# swimming pools are not permitted obstructions in any #front yard#;
  - (10) Walls, not exceeding eight feet in height above adjoining grade and not roofed or part of a #building#, and not exceeding four feet in height in any #front yard#, except that for #corner lots#, a wall may be up to six feet in height within that portion of one #front yard# that is between a #side lot line# and the prolongation of the side wall of the #residence# facing such #side lot line#;
- (b) In any #rear yard# or #rear yard equivalent# :
- (1) Balconies, unenclosed, subject to the provisions of Section 23-13;
  - (2) Parking spaces, off-street, #accessory#, for automobiles or bicycles, provided that:



- (i) if #accessory# to a #single-# or #two-family residence#, the height of a #building# containing such parking spaces shall not exceed 10 feet in height above the adjoining grade and such #building# shall be #detached# from such #residence#. Furthermore, if located in an R1 District, such #building# may not be nearer than five feet to a #rear lot line# or #side lot line#. In R2A Districts, detached garages shall be included in #lot coverage#;
- (ii) if #accessory# to any other kind of #building# containing #residences#, the height of a #building#, or portion thereof, containing such parking spaces within the #rear yard#, shall not exceed 10 feet above adjoining grade, including the apex of a pitched roof in R3, R4 or R5 Districts, or 15 feet above #curb level# or #base plane#, as applicable, in R6, R7, R8, R9 or R10 Districts. In addition, decks, parapet walls, roof thickness, skylights, vegetated roofs, and weirs, as set forth in Section 23-62 (Permitted Obstructions), limited to 18 inches in height, as measured perpendicular to the roof surface, shall be permitted upon the roof of such #accessory# #building# within the #rear yard#;
- (iii) enclosed #accessory# parking spaces for bicycles shall be #accessory# to a #residence# other than a #single-# or #two-family residence#, attached to a #building#, and the area dedicated to such spaces shall not exceed the area of bicycle parking spaces permitted to be excluded from #floor area# pursuant to Section 25-85 (Floor Area Exemption);
- (3) any portion of a #building# used for #residential uses# other than #dwelling units# in #Quality Housing buildings# containing #affordable independent residences for seniors# on #zoning lots# meeting the criteria set forth in paragraph (a)(4) of Section 23-664 (Modified height and setback regulations for certain Inclusionary Housing buildings or affordable independent residences for seniors), provided that:
  - (i) such #zoning lot# is located in an R6 through R10 District other than an R6B, R7B or R8B District;
  - (ii) the height of such #building# portion does not exceed one #story#, or 15 feet above the adjoining grade, whichever is less;
  - (iii) such #building# portion is located within 100 feet of a #wide street#; and
  - (iv) such space shall be accessible to all residents of the #building#.

In addition, decks, parapet walls, roof thickness, skylights, vegetated roofs and weirs, as set forth in Section 23-62 (Permitted Obstructions), limited to 18 inches in height, as measured perpendicular to the roof surface, shall be permitted upon the roof of such portion of a #building# within the #rear yard#.

However, no portion of a #rear yard equivalent# which is also a required #front yard# or required #side yard# may contain any obstructions not permitted in such #front yard# or #side yard#.

**23-441**

**23-443**

**Location of garages in side yards of corner lots**

In all #Residence Districts#, on #corner lots#, enclosed #accessory# off-street parking spaces shall be considered permitted obstructions in any portion of a #side yard# which is within 30 feet of both #side lot lines#, provided that, in an R1 or R2A District, on a #corner lot# whose mean width is 45 feet or more, no structure used for such purposes shall be less than five feet from any #side lot line#. In R2A Districts, detached garages shall be included in #lot coverage#.

**23-442**

**23-444**

**Location of garages in side yards of other zoning lots**

In all #Residence Districts#, on #zoning lots# other than #corner lots#, where no #rear yard# is required under the provisions of Sections 23-541 (Within one hundred feet of corners) or 23-542 (Along short dimension of block), enclosed #accessory# off-street parking spaces shall be considered permitted obstructions in any portion of a #side yard# that is within 30 feet of the #rear lot line#.

\* \* \*

**23-461**

**Side yards for single- or two-family residences**

R1 R2 R3 R4 R5 R6 R7 R8 R9 R10

\* \* \*

(c) Additional regulations

(3) Permitted obstructions in open areas between #buildings#

Only #accessory# mechanical equipment limited in depth to 18 inches from an exterior wall ~~air conditioning condensation units, chimneys, downspouts, eaves, exterior wall thickness,~~ gutters, open #accessory# off-street parking spaces, #qualifying exterior wall thickness#, ramps for access by people with disabilities, and steps as set forth in ~~paragraph (a) the applicable provisions of Section 23-44, inclusive,~~ shall be permitted obstructions in open areas required pursuant to paragraphs (c)(1) and (c)(2) of this Section, provided that such obstructions, not including #accessory# off-street parking spaces, #qualifying exterior wall thickness# or #accessory# mechanical equipment, may not reduce the minimum width of the open area by more than three feet.

\* \* \*

**23-462**

**Side yards for all other buildings containing residences**

R3-2 R4 R5 R6 R7 R8 R9 R10

In the districts indicated, except as set forth in Section 23-461 (Side yards for single- or two-family residences) or Section 23-49 (Special Provisions for Side Lot Line Walls), #side yards# shall be provided for all #zoning lots# with #buildings# containing #residences# as provided in this Section:

R6 R7 R8 R9 R10

- (c) In the districts indicated, no #side yards# are required. However, if any open area extending along a #side lot line# is provided at any level, it shall have a minimum width of eight feet, measured perpendicular to the #side lot line#, and extend along the entire #side lot line#, except where a #court# is provided in accordance with the applicable provisions of Section 23-60 (HEIGHT AND SETBACK REGULATIONS). ~~Obstructions permitted pursuant to paragraph (a) of~~ The allowances for permitted obstructions in any #yard# or #rear yard equivalent# set forth in Section 23-44 (Permitted Obstructions in Required Yards or Rear Yard Equivalents) shall be permitted in such open areas.

\* \* \*

**23-60  
HEIGHT AND SETBACK REGULATIONS**

\* \* \*

**23-62  
Permitted Obstructions**

In all #Residence Districts#, the obstructions set forth in this Section, inclusive, shall be permitted to penetrate a maximum height limit or #sky exposure plane# set forth in Sections 23-63 (Height and Setback Requirements in R1 Through R5 Districts), 23-64 (Basic Height and Setback Requirements), 23-66 (Height and Setback Requirements for Quality Housing Buildings) or 23-69 (Special Height Limitations).

[EXISTING PERMITTED OBSTRUCTION LIST BEING SPLIT INTO A GLOBAL LIST AND A RESIDENCE DISTRICT SPECIFIC LIST]

~~In all #Residence Districts#, except as provided in Section 23-621 (Permitted obstructions in certain districts), the obstructions listed in paragraphs (a) through (r) in this Section shall be permitted to penetrate a maximum height limit or #sky exposure plane# set forth in Sections 23-63 (Height and Setback Requirements in R1 Through R5 Districts), 23-64 (Basic Height and Setback Requirements), 23-66 (Height and Setback Requirements for Quality Housing Buildings) or 23-69 (Special Height Limitations):~~

- (a) ~~Awnings and other sun control devices, provided that when located at a level higher than the first #story#, excluding a #basement#, all such awnings and other sun control devices:
 
  - (1) ~~shall be limited to a maximum projection from a #building# wall of 2 feet, 6 inches, except when located on the first #story# above a setback;~~
  - (2) ~~shall have solid surfaces that, in aggregate, cover an area no more than 30 percent of the area of the #building# wall (as viewed in elevation) from which they project; and~~
  - (3) ~~may rise above the permitted #building# height, up to the height of a parapet wall or guardrail permitted in accordance with paragraph (j) of this Section.~~~~

~~When located on the first #story# above a setback, awnings and other sun control devices shall be limited to a projection of 50 percent of the depth of the required setback, and shall be limited, in total, to 50 percent of the width of the #building# wall from which they project;~~

- (b) ~~Balconies, unenclosed, subject to the provisions of Section 23-13;~~
- (c) ~~#Building# columns, having an aggregate width equal to not more than 20 percent of the #aggregate width of street walls# of a #building#, to a depth not exceeding 12 inches, in an #initial setback~~

distance#, optional front open area, or any other required setback distance or open area set forth in Sections 23-63, 23-64, 23-65 (Tower Regulations) or 23-66;

- (d) Chimneys or flues, with a total width not exceeding 10 percent of the #aggregate width of street walls# of a #building# at any level;
- (e) Decks, and other surfaces for recreational activities, not more than 3 feet, 6 inches in height, as measured from the maximum height limit, or the finished level of the roof as it existed on April 30, 2012, whichever is higher;
- (f) Dormers having an #aggregate width of street walls# equal to not more than 50 percent of the width of the #street wall# of a #detached# or #semi-detached# #single # or #two-family residence#;
- (g) Elevator or stair bulkheads (including shafts; and vestibules not larger than 60 square feet in area providing access to a roof), roof water tanks and #accessory# mechanical equipment (including enclosures), other than solar or wind energy systems, provided that:
  - (1) such obstructions shall be located not less than 10 feet from the #street wall# of a #building#, except that such obstructions need not be set back more than 25 feet from a #narrow# #street line# or more than 20 feet from a #wide# #street line#. However, such restrictions on location shall not apply to elevator or stair bulkheads (including shafts or vestibules), provided the #aggregate width of street walls# of such bulkheads within 10 feet of a #street wall#, facing each #street# frontage, times their average height, in feet, does not exceed an area equal to four times the width, in feet, of the #street wall# of the #building# facing such frontage;
  - (2) all mechanical equipment shall be screened on all sides;
  - (3) such obstructions and screening are contained within a volume that complies with one of the following:
    - (i) the product, in square feet, of the #aggregate width of street walls# of such obstructions facing each #street# frontage, times their average height, shall not exceed an area equal to eight feet times the width, in feet, of the #street wall# of the #building# facing such frontage; or
    - (ii) the #lot coverage# of all such obstructions does not exceed 20 percent of the #lot coverage# of the #building#, and where the maximum permitted height of a #building# is less than 120 feet, such obstructions are limited to a maximum height of 25 feet, and where the maximum permitted height of a #building# is 120 feet or greater, such obstructions are limited to a maximum height of 40 feet.

For the purposes of this paragraph, (g), #abutting# #buildings# on a single #zoning lot# may be considered to be a single #building#;

- (h) Exterior wall thickness, up to eight inches, where such wall thickness is added to the exterior face of a #building# wall existing on April 30, 2012, provided the added wall thickness has a thermal resistance (R-value) of at least 1.5 per inch. Where #buildings# that have added exterior wall thickness pursuant to this Section are #enlarged#, such #enlarged# portion may similarly penetrate a maximum height limit in order to align with the exterior walls of the existing #building#, provided such #enlargement# contains less #floor area# than the existing #building#, and there is no penetration of #floor area# above a maximum height limit;
- (i) Flagpoles or aerials;

- (j) Parapet walls, not more than four feet in height, as measured from the maximum height limit, or the finished level of the roof as it existed on April 30, 2012, whichever is higher. A guardrail with a surface at least 70 percent open or with an opacity no more than 30 percent (as viewed in elevation), shall be permitted above a parapet wall or within two feet of a parapet wall, provided such guardrail is not more than four feet above the accessible level of a roof. Such restriction on guardrail height shall not apply when located beyond two feet from a parapet wall;
- (k) Roof thickness, up to eight inches, to accommodate the addition of insulation, for #buildings# or portions of #buildings# constructed prior to April 30, 2012. For a #building# that has added roof thickness pursuant to this paragraph, an #enlargement# may align with the finished roof surface of such #building#, provided the #enlarged# portion does not exceed the maximum height limit by more than eight inches;
- (l) Skylights, clerestories or other daylighting devices, not more than four feet in height, as measured from the maximum height limit, or the finished level of the roof as it existed on April 30, 2012, whichever is higher. Such devices shall be limited to a #lot coverage# not greater than 10 percent of the #lot coverage# of the roof and be located at least eight feet from the #street wall# edge. However, such devices shall not be permitted obstructions above a roof with a slope greater than 20 degrees;
- (m) Solar energy systems:
  - (1) on the roof of a #building#, up to four feet in height, as measured from the maximum height limit, or the finished level of the roof, whichever is higher;
  - (2) on the roof of a #building#, greater than four feet in height, as measured from the maximum height limit, or the finished level of the roof, whichever is higher, provided that all such portions above four feet are set back at least six feet from a #street wall#, limited to a #lot coverage# not greater than 25 percent of the #lot coverage# of the roof and do not exceed:
    - (i) in R1 through R5 Districts, a height of six feet;
    - (ii) in R6 through R10 Districts, a height of 15 feet; and
    - (iii) when located on a bulkhead or other obstruction pursuant to paragraph (g) of this Section, a height of six feet;
  - (3) on walls existing on April 30, 2012, projecting no more than 10 inches and occupying no more than 20 percent of the surface area of the #building# wall (as viewed in elevation) from which it projects.

However, any installation on a roof with a slope greater than 20 degrees shall be limited to 18 inches in height, as measured perpendicular to the roof surface.
- (n) Vegetated roofs, not more than 3 feet, 6 inches in height, excluding vegetation, as measured from the maximum height limit, or the finished level of the roof as it existed on April 30, 2012, whichever is higher. On roofs with slopes greater than 20 degrees, vegetated roofs shall be limited to a height of 12 inches measured perpendicular to such roof surface;
- (o) Weirs, check dams and other equipment for stormwater management, not more than 3 feet, 6 inches in height, as measured from the maximum height limit, or the finished level of the roof as it existed on April 30, 2012, whichever is higher;

- (p) ~~Wind energy systems on portions of #buildings# with a height of 100 feet or greater, provided:~~
  - (1) ~~the highest point of the wind turbine assembly does not exceed 55 feet;~~
  - (2) ~~no portion of the wind turbine assembly is closer than 10 feet to any #lot line#; and~~
  - (3) ~~the diameter of the swept area of the rotor does not exceed 15 feet;~~
- (q) ~~Window washing equipment mounted on a roof;~~
- (r) ~~Wire, chain link or other transparent fences.~~

\* \* \*

### **23-621**

#### **General permitted obstructions**

In all #Residence Districts#, the following obstructions shall be permitted to penetrate a maximum height limit or #sky exposure plane#. These allowances are generally common to #Residence#, #Commercial# and #Manufacturing Districts#.

- (a) Awnings and other sun control devices, provided that when located at a level higher than the first #story#, excluding a #basement#, all such awnings and other sun control devices:
  - (1) shall be limited to a maximum projection from a #building# wall of 2 feet, 6 inches, except when located on the first #story# above a setback;
  - (2) shall have solid surfaces that, in aggregate, cover an area no more than 30 percent of the area of the #building# wall (as viewed in elevation) from which they project; and
  - (3) may rise above the permitted #building# height, up to the height of a parapet wall or guardrail permitted in accordance with this Section.

When located on the first #story# above a setback, awnings and other sun control devices shall be limited to a projection of 50 percent of the depth of the required setback, and shall be limited, in total, to 50 percent of the width of the #building# wall from which they project;

- (b) #Building# columns, having an aggregate width equal to not more than 20 percent of the #aggregate width of street walls# of a #building#, to a depth not exceeding 12 inches, in an #initial setback distance#, optional front open area, or any other required setback distance or open area set forth in the applicable height and setback regulations;
- (c) Chimneys or flues, with a total width not exceeding 10 percent of the #aggregate width of street walls# of a #building# at any level;
- (d) Decks, and other surfaces for recreational activities, not more than 3 feet, 6 inches in height, as measured from the maximum height limit;
- (e) Flagpoles or aerials;
- (f) Parapet walls, not more than four feet in height, as measured from the maximum height limit. A guardrail with a surface at least 70 percent open or with an opacity no more than 30 percent (as viewed in elevation), shall be permitted above a parapet wall or within two feet of a parapet wall,

provided such guardrail is not more than four feet above the accessible level of a roof. Such restriction on guardrail height shall not apply when located beyond two feet from a parapet wall;

- (g) #Qualifying exterior wall thickness#
- (h) Roof thickness, up to 12 inches, to accommodate the addition of insulation, for #buildings# or portions of #buildings# constructed prior to [date of adoption]. For a #building# that has added roof thickness pursuant to this paragraph, the height of any other permitted obstruction may be measured from the finished level of the roof instead of the maximum height limit or #sky exposure plane#.
- (i) Skylights, clerestories or other daylighting devices, not more than four feet in height, as measured from the maximum height limit. Such devices shall be limited to a #lot coverage# not greater than 10 percent of the #lot coverage# of the roof and be located at least eight feet from the #street wall# edge. However, such devices shall not be permitted obstructions above a roof with a slope greater than 20 degrees;
- (j) Solar energy systems, #accessory# or as part of an #energy infrastructure equipment#:
  - (1) on the roof, or any portion thereof, of a #building#, with a slope less than 20 degrees: up to a height of 15 feet, or, when located on a bulkhead or other obstruction of this Section, a height of six feet; or
  - (2) on the roof, or any portion thereof, of a #building#, which has a slope of more than 20 degrees: up to a height of 60 inches in height, as measured perpendicular to the roof surface;
- (k) Vegetated roofs, not more than 3 feet, 6 inches in height, excluding vegetation, as measured from the maximum height limit. On roofs with slopes greater than 20 degrees, vegetated roofs shall be limited to a height of 12 inches measured perpendicular to such roof surface;
- (l) Weirs, check dams and other equipment for stormwater management, not more than 3 feet, 6 inches in height, as measured from the maximum height limit;
- (m) Window washing equipment mounted on a roof;
- (n) Wire, chain link or other transparent fences.

\* \* \*

### **23-622**

#### **Additional permitted obstructions**

In all #Residence Districts#, the obstructions set forth in Section 23-621 (General permitted obstructions), as well as the following obstructions, shall be permitted to penetrate a maximum height limit or #sky exposure plane#.

- (a) Balconies, unenclosed, subject to the provisions of Section 23-13;
- (b) Dormers having an #aggregate width of street walls# equal to not more than 50 percent of the width of the #street wall# of a #detached# or #semi-detached# #single-# or #two-family residence#;
- (c) Elevator or stair bulkheads (including shafts; and vestibules not larger than 60 square feet in area providing access to a roof), roof water tanks, #energy infrastructure equipment#, and #accessory#

mechanical equipment (including enclosures), other than solar or wind energy systems (whether #accessory# or as part of #energy infrastructure equipment#), provided that:

- (1) such obstructions shall be located not less than 10 feet from the #street wall# of a #building#, except that such obstructions need not be set back more than 25 feet from a #narrow# #street line# or more than 20 feet from a #wide# #street line#. However, such restrictions on location shall not apply to elevator or stair bulkheads (including shafts or vestibules), provided the #aggregate width of street walls# of such bulkheads within 10 feet of a #street wall#, facing each #street# frontage, does not exceed 30 percent of the #street wall# width of the #building# facing such frontage;
- (2) the aggregate area of such obstructions, including any required screening, does not exceed 50 percent of the #lot coverage# of the #building#;
- (3) the height of obstructions within an aggregate area equivalent to at least 20 percent of the #lot coverage# of the #building# shall not exceed 15 feet above the maximum permitted height; and
- (4) the height of obstructions within the remaining #lot coverage#, not to exceed 30 percent of the #building# shall not exceed:
  - (i) in R3-2, R4, and R5 Districts, except R4-1, R4A, R4B and R5A Districts, a height of 25 feet above the maximum permitted height;
  - (ii) in R6 through R10 Districts:
    - (i) where the maximum permitted height of a #building# is 120 feet or lower, a height of 35 feet above the maximum permitted height; and
    - (ii) where the maximum permitted height of a #building# is greater than 120 feet, a height of 55 feet above the maximum permitted height; and
- (5) all equipment shall be subject to the applicable provisions of Section 26-60 (SPECIAL SCREENING AND ENCLOSURE PROVISIONS);
- (d) Wind energy systems, #accessory# or as part of an #energy infrastructure equipment#, on portions of #buildings# with a height of 100 feet or greater, provided:
  - (1) the highest point of the wind turbine assembly does not exceed 55 feet;
  - (2) no portion of the wind turbine assembly is closer than 10 feet to any #lot line#; and
  - (3) the diameter of the swept area of the rotor does not exceed 15 feet;

**23-621**

**23-623**

**Permitted obstructions in certain districts**

R2A R2X R3 R4 R4-1 R4A R5A



- (a) In the districts indicated, permitted obstructions are limited to chimneys, ~~#qualifying~~ exterior wall thickness#, flag poles or aerials, parapet walls, roof thickness, skylights, solar energy systems and vegetated roofs pursuant to Section 23-621. However, in R3-2 and R4 Districts, except R4-1, R4A and R4B Districts, elevator or stair bulkheads, roof water tanks, ~~#energy infrastructure equipment#~~ and ~~#accessory#~~ mechanical equipment ~~provided pursuant to paragraph (g) of Section 23-62~~ shall additionally be permitted ~~for #buildings# containing #affordable independent residences for seniors#.~~
- (b) In R2X Districts, dormers may be considered permitted obstructions if:
- (1) the aggregate width of dormers facing the #street line# is equal to not more than 50 percent of the width of the #street wall line#;
  - (2) the aggregate width of dormers facing the #rear lot line# is equal to not more than 50 percent of the width of the #rear wall line#;
  - (3) the aggregate width of dormers facing a #side lot line# is equal to not more than 50 percent of the width of a straight line connecting and perpendicular to the #street wall line# and the #rear wall line#; and
  - (4) on a #corner lot#, the aggregate width of dormers facing a #side lot line# is equal to not more than 50 percent of the width of the #rear wall line# facing such #side lot line#.

#### R6 R7 R8 R9 R10

- (c) In the districts indicated, for #Quality Housing buildings#, ~~the permitted obstructions set forth in Section 23-62 shall apply to any #building or other structure#, except that~~ within a required front setback distance above a maximum base height, the following rules shall apply:
- (1) Dormers shall be allowed as a permitted obstruction, provided that on any #street# frontage, the aggregate width of all dormers at the maximum base height does not exceed 60 percent of the width of the #street wall# of the highest #story# entirely below the maximum base height. For each foot above the maximum base height, the aggregate width of all dormers shall be decreased by one percent of the #street wall# width of the highest #story# entirely below the maximum base height.

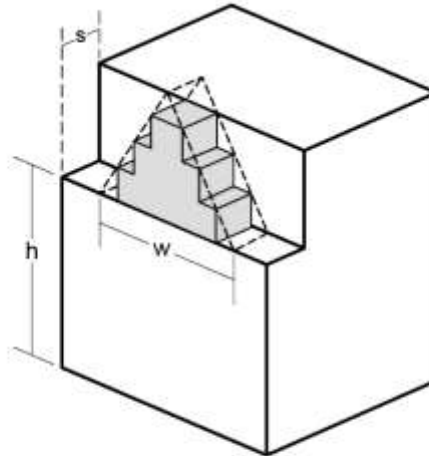

h - Maximum base height  
 s - Required setback or *initial setback distance*  
 w - Maximum width of dormer at maximum base height (60% of *street wall width* of highest story entirely below maximum base height)  
 [Shaded Box] Dormer

- (2) Solar energy systems on a roof shall be limited to four feet or less in height, as measured from the maximum height limit, or the finished level of the roof, whichever is higher. However, on a roof with a slope greater than 20 degrees, such systems shall be limited to 18 inches in height as measured perpendicular to the roof surface.
- (3) Wind energy systems shall not be allowed as permitted obstructions.
- (4) Window washing equipment shall not be allowed as permitted obstructions.

\* \* \*

**23-663  
 Tower regulations in R9D and R10X districts**

**R9D R10X**

In the districts indicated, any #Quality Housing building# #or other structure#, or portions thereof, which in the aggregate occupies not more than 40 percent of the #lot area# of a #zoning lot# (or, for #zoning lots# of less than 20,000 square feet, the percentage set forth in the table in Section 23-651), above a height of 85 feet above the #base plane#, is hereinafter referred to as a tower. Dormers permitted within a required setback area pursuant to Section ~~23-621~~ 23-623 (Permitted obstructions in certain districts) shall not be counted towards tower coverage. Such tower may exceed a height limit of 85 feet above the #base plane# provided the base of such tower complies with the applicable #street wall# location and height and setback provisions of Sections 23-661 and 23-662, respectively, and provided that the tower portion complies with the following, as applicable:

\* \* \*

**23-711  
Standard minimum distance between buildings**

R1 R2 R3 R4 R5 R6 R7 R8 R9 R10

\* \* \*

In addition, the following rules shall apply:

- (f) in R1, R2, R3, R4A and R4-1 Districts within #lower density growth management areas#, the provisions of this paragraph, (f), shall apply to any #zoning lot# with two or more #buildings# where at least 75 percent of the #floor area# of one #building# is located beyond 50 feet of a #street line# and the #private road# provisions do not apply. For the purposes of this paragraph, any #building# containing #residences# with no #building# containing #residences# located between it and the #street line# so that lines drawn perpendicular to the #street line# do not intersect any other #building# containing #residences# shall be considered a “front building,” and any #building# containing #residences# with at least 75 percent of its #floor
- (g) ~~for #buildings# existing on April 30, 2012, the minimum distances set forth in the table in this Section, and any #non-complying# distance greater than eight feet, may be reduced by up to eight inches of exterior wall thickness, provided the added wall thickness has a thermal resistance (R-value) of at least 1.5 per inch. A #non-complying# distance of eight feet or less shall be limited to a total reduction of one inch of wall thickness for each foot of such existing distance between buildings.~~

The obstructions permitted for any #yard# set forth in paragraph (a) of Section 23-441 (General permitted obstruction allowances), shall be permitted in such minimum distance.

\* \* \*

**23-80  
COURT REGULATIONS, MINIMUM DISTANCE BETWEEN WINDOWS AND WALLS OR LOT LINES AND OPEN AREA REQUIREMENTS**

\* \* \*

**23-861  
General provisions**

R1 R2 R3 R4 R5 R6 R7 R8 R9 R10

In all districts, as indicated, except as otherwise provided in Section 23-862 (Minimum distance between legally required windows and lot lines on small corner lots in R9 or R10 Districts) or Section 23-863 (Minimum distance between legally required windows and any wall in an inner court), the minimum distance between a #legally required window# and:

- (a) any wall;
- (b) a #rear lot line#, or vertical projection thereof; or

(c) a #side lot line#, or vertical projection thereof;

shall be 30 feet, measured in a horizontal plane at the sill level of, and perpendicular to, such window for the full width of the rough window opening; provided, however, that a #legally required window# may open on any #outer court# meeting the requirements of Section 23-84 (Outer Court Regulations), except for small #outer courts# in R6 through R10 Districts, the provisions for which are set forth in paragraph (b) of Section 23-841 (Narrow outer courts).

The obstructions permitted for any #yard# set forth in paragraph (a) of Section 23-441 (General permitted obstruction allowances), shall be permitted in such minimum distance.

However, for shallow #interior lots# in R6 through R10 Districts, the minimum distance between a #legally required window# and a #rear lot line#, or vertical projection thereof, may be reduced to equal the #rear yard# depth required pursuant to the provisions of Section 23-52 (Special Provisions for Shallow Interior Lots). However, in no event shall such minimum distance between a #legally required window# and a #rear lot line#, or vertical projection thereof, be less than 20 feet.

In R3, R4 and R5 Districts, the minimum dimension between a #legally required window# and a #side lot line# shall be 15 feet. Such 15 foot dimension shall be measured in a horizontal plane perpendicular to the #side lot line# or vertical projection thereof. Furthermore, such area with a 15 foot dimension shall be open to the sky from ground level up for the entire length of the #side lot line#. Only #accessory# mechanical equipment limited in depth to 18 inches from an exterior wall ~~air conditioning condensation units~~, chimneys, downspouts, eaves, ~~exterior wall thickness~~ #qualifying exterior wall thickness#, gutters, open #accessory# off-street parking spaces, ramps for access by the handicapped, and steps shall be permitted obstructions in such open area, subject to the conditions set forth in ~~paragraph (a)~~ of Section 23-44 (Permitted Obstructions in Required Yards or Rear Yard Equivalents), ~~and provided that such obstructions, not including #qualifying exterior wall thickness# and #accessory# mechanical equipment,~~ will not reduce the minimum width of the open area by more than three feet.

\* \* \*

**23-862  
Minimum distance between legally required windows and lot lines on small corner lots in R9 or R10 Districts**

R9 R10

In the districts indicated, on a #corner lot# less than 10,000 square feet in #lot area#, a #legally required window# may open on a #yard# bounded on one side by a #front lot line# and having a minimum width of 20 feet, provided that the provisions of Section 23-44 (Permitted Obstructions in Required Yards or Rear Yard Equivalents) shall not apply to such #yard#. However, #accessory# mechanical equipment limited in depth to 18 inches from an exterior wall, awnings and other sun control devices, ~~exterior wall thickness~~ #qualifying exterior wall thickness#, and solar energy systems on walls, as set forth in Section 23-44 (Permitted Obstructions in Required Yards or Rear Yard Equivalents), shall be permitted within such minimum distance.

\* \* \*

**23-87  
Permitted Obstructions in Courts**

R1 R2 R3 R4 R5 R6 R7 R8 R9 R10

In all districts, as indicated, the obstructions permitted for any #yard# set forth in paragraph (a) of Section 23-441 (General permitted obstruction allowances), as well as the following obstructions, shall be permitted within the minimum area and dimensions needed to satisfy the requirements for a #court#. For the purposes of applying such allowances to #courts#, all percentage calculations shall be applied to the area of the #court# instead of the #yard#:

- (a) ~~Arbors or trellises;~~
- (b) ~~Awnings and other sun control devices. However, when located at a level higher than the first #story#, excluding a #basement#, all such devices:
 
  - (1) ~~shall be limited to a maximum projection from a #building# wall of 2 feet, 6 inches; and~~
  - (2) ~~shall have solid surfaces that, in aggregate, cover an area no more than 30 percent of the area of the #building# wall (as viewed in elevation) from which they project;~~~~
- (c) ~~Eaves, gutters, downspouts, window sills, or similar projections extending into such #court# not more than four inches;~~
- (d) ~~Exterior wall thickness, where such wall thickness is added to the exterior face of a #building# wall existing on April 30, 2012, provided the added wall thickness has a thermal resistance (R value) of at least 1.5 per inch, and is limited to one inch of thickness for every foot of existing #court# width, up to a maximum thickness of eight inches;~~

~~Where #buildings# that have added exterior wall thickness pursuant to this Section are #enlarged#, such #enlarged# portion may similarly encroach upon required #courts# in order to align with the exterior walls of the existing #building#, provided such #enlargement# contains less #floor area# than the existing #building#, and there is no encroachment of #floor area# into a required #court#;~~

- ~~(e)(a) Fences;~~
- ~~(f)(b) Fire escapes in #outer courts#;~~

~~Fire escapes in #outer court recesses# not more than five feet in depth;~~

~~Fire escapes in #inner courts# where such fire escapes are required as a result of alterations in #buildings# existing before December 15, 1961;~~

~~Fire escapes in #outer court recesses# more than five feet in depth where such fire escapes are required as a result of alterations in #buildings# existing before December 15, 1961;~~

- (g) ~~Flagpoles;~~
- (h)(c) ~~Open terraces, porches, steps, ramps or lifts for people with physical disabilities;~~
- ~~(i)(d) #Energy infrastructure equipment# and #accessory# mechanical equipment, subject to the requirements set forth in Section 23-442;~~

[MOVING SCREENING PROVISIONS TO SECTION 26-60]

~~#Accessory# power systems, including, but not limited to, generators, solar energy systems, fuel cells, batteries and other energy storage systems, provided that:~~

- (1) ~~all equipment shall be subject to the following location, enclosure, and screening requirements, as applicable:~~
  - (i) ~~all generators and cogeneration equipment #accessory# to #buildings# other than #single # or #two family residences# shall be completely enclosed within a #building or other structure#, except as necessary for mechanical ventilation;~~
  - (ii) ~~all other types of equipment, including generators and cogeneration equipment serving #single # or #two family residences#, may be unenclosed, provided that such equipment is located at least five feet from any #lot line#. However, if the area bounding all such equipment, as drawn by a rectangle from its outermost perimeter in plan view, exceeds 25 square feet, such equipment shall be screened in its entirety on all sides. Such screening may be opaque or perforated, provided that where perforated materials are provided, not more than 50 percent of the face is open;~~
  - (iii) ~~where any equipment is located between a #street wall#, or prolongation thereof, and a #street line#, the entire width of such portion of the equipment facing a #street#, whether open or enclosed, shall be fully screened by vegetation; and~~
- (2) ~~the size of all equipment, including any screening or portions of any #building or other structure# enclosing such equipment, shall not exceed:~~
  - (i) ~~an area equivalent to 25 percent of any #court# containing #legally required windows#;~~
  - (ii) ~~in R1 through R5 Districts, a height of 10 feet above the lowest level of such #court#; and~~
  - (iii) ~~in R6 through R10 Districts, a height of 15 feet above the lowest level of such #court#.~~

~~(j)~~ (e) Recreational or drying yard equipment;

(k) ~~Solar energy systems on walls existing on April 30, 2012, projecting no more than 10 inches and occupying no more than 20 percent of the surface area of the #building# wall (as viewed in elevation) from which it projects.~~

In addition, for #courts# at a level higher than the first #story#, decks, skylights, parapet walls, roof thickness, solar energy systems up to four feet high, vegetated roofs, and weirs, as set forth in Section 23-62 (Permitted Obstructions), shall be permitted.

\* \* \*

**Chapter 4  
Bulk Regulations for Community Facilities in Residence Districts**

\* \* \*

**24-30  
YARD REGULATIONS**

\* \* \*

## 24-33

**Permitted Obstructions in Required Yards or Rear Yard Equivalents**

In all #Residence Districts#, the obstructions set forth in Section 23-441 (General permitted obstruction allowances), as well as the following obstructions, shall be permitted when located within a required #yard# or #rear yard equivalent#:

(a) In any #yard# or #rear yard equivalent#:

- (1) Arbors or trellises;
- (2) Awnings and other sun control devices, provided that when located at a level higher than the first #story#, excluding a #basement#, all such awnings and other sun control devices:
  - (i) shall be limited to a maximum projection of 2 feet, 6 inches into such required #yard#; and
  - (ii) shall have solid surfaces that, in aggregate, cover an area no more than 30 percent of the area of the #building# wall (as viewed in elevation) from which they project;
- (3) Canopies;
- (4) Chimneys, projecting not more than three feet into, and not exceeding two percent of the area of, the required #yard# or #rear yard equivalent#;
- (5) Eaves, gutters or downspouts, projecting into such #yard# or #rear yard equivalent# not more than 16 inches or 20 percent of the width of such #yard# or #rear yard equivalent#, whichever is the lesser distance;
- (6) Exterior wall thickness, where such wall thickness is added to the exterior face of a #building# wall existing on April 30, 2012, provided the added wall thickness has a thermal resistance (R-value) of at least 1.5 per inch, and is limited to one inch of thickness for every foot of existing #yard# width, up to a maximum thickness of eight inches. When an open area is provided along a common #lot line#, then such exterior wall thickness is limited to one inch for every foot of existing open area on the #zoning lot#;

Where #buildings# that have added exterior wall thickness pursuant to this Section are #enlarged#, such #enlarged# portion may similarly encroach upon required #yards# in order to align with the exterior walls of the existing #building#, provided such #enlargement# contains less #floor area# than the existing #building#, and there is no encroachment of #floor area# into a required #yard#;

- ~~(7)~~(1) Fences;
- (8) Flagpoles;
- ~~(9)~~(2) Parking spaces for automobiles or bicycles, off-street, open, #accessory#;
- (3) #Energy infrastructure equipment# and #accessory# mechanical equipment, subject to the requirements set forth in Section 23-442 (Additional permitted obstructions);

- (10) ~~#Accessory# power systems, including, but not limited to, generators, solar energy systems, fuel cells, batteries and other energy storage systems, provided that:~~
- (i) ~~all equipment shall be subject to the following location, enclosure, and screening requirements, as applicable:~~
    - (a) ~~all generators and cogeneration equipment shall be completely enclosed within a #building or other structure#, except as necessary for mechanical ventilation;~~
    - (b) ~~all other types of equipment may be unenclosed, provided that such equipment is located at least five feet from any #lot line#. However, if the area bounding all such equipment, as drawn by a rectangle from its outermost perimeter in plan view, exceeds 25 square feet, the entirety of such equipment shall be screened on all sides. Such screening may be opaque or perforated, provided that where perforated materials are provided, not more than 50 percent of the face is open;~~
    - (c) ~~where any equipment is located in a #front yard#, the entire width of such portion of the equipment facing a #street#, whether open or enclosed, shall be fully screened by vegetation; and~~
  - (ii) ~~the size of all equipment, including any screening or portions of any #building or other structure# enclosing such equipment, shall not exceed:~~
    - (a) ~~an area equivalent to 25 percent of a required #yard#, or #rear yard equivalent#, and in addition, in #front yards#, is limited to an area not exceeding 25 square feet. However, for #corner lots#, one #front yard# may be treated as a #side yard# for the purpose of applying such size restrictions;~~
    - (b) ~~in R1 through R5 Districts, a height of 10 feet above the adjoining grade in #rear yards#, #rear yard equivalents# and #side yards#, or a height of five feet above the adjoining grade in #front yards#; and~~
    - (c) ~~in R6 through R10 Districts, a height of 15 feet above the adjoining grade;~~
- (11) Solar energy systems, on walls existing on April 30, 2012, projecting no more than 10 inches and occupying no more than 20 percent of the surface area of the #building# wall (as viewed in elevation) from which it projects;
- ~~(12)(4) Steps, and ramps or lifts for people with physical disabilities;~~
- (13) Terraces or porches, open;
- ~~(14)(5) Walls, not exceeding eight feet in height and not roofed or part of a #building#.~~
- (b) In any #rear yard# or #rear yard equivalent#:
- (1) Balconies, unenclosed, subject to the provisions of Section ~~24-165~~ 24-166;
  - ~~(2) Breezeways;~~



- (3)(2) Any #building# or portion of a #building# used for #community facility# #uses#, including #accessory# parking spaces for bicycles within such #building#, provided that the height of such #building# shall not exceed one #story#, nor in any event 23 feet above #curb level#, and further provided that the area within such #building# dedicated to #accessory# parking spaces for bicycles shall not exceed the area permitted to be excluded from #floor area#, pursuant to Section 25-85 (Floor Area Exemption). In addition, decks, parapet walls, roof thickness, skylights, vegetated roofs and weirs, pursuant to Section 24-51 (Permitted Obstructions), shall be permitted above such an #accessory building#, or portion thereof. However, the following shall not be permitted obstructions:
- (i) in all #Residence Districts#, any portion of a #building# containing rooms used for living or sleeping purposes, other than a room in a hospital used for the care or treatment of patients;
  - (ii) in R1, R2, R3-1, R3A, R3X, R4-1 R4A or R4B Districts, any portion of a #building# used for any #community facility# #use#;
  - (iii) in all #Residence Districts# not listed in paragraph (b)(3)(ii) of this Section, beyond 100 feet of a #wide street#, any portion of a #building# used for a #community facility# #use# other than a #school#, house of worship, college or university, or hospital and related facilities;
- (4) ~~Fire escapes;~~
- (5) ~~Greenhouses, #accessory#, non-commercial, limited to one #story# or 15 feet in height above natural grade level, whichever is less, and limited to an area not exceeding 25 percent of a required #rear yard# or #rear yard equivalent# on a #zoning lot#;~~
- (6) (3) Parking spaces, off-street, #accessory# to a #community facility# #use#, provided that the height of an #accessory building#, or portion of a #building# used for such purposes, shall not exceed 15 feet above #curb level#. However, such #accessory building# or portion of a #building# shall not be a permitted obstruction in R1, R2, R3-1, R3A, R3X, R4-1, R4A or R4B Districts;
- (7) ~~Recreation or drying yard equipment;~~
- (8) ~~Sheds, tool rooms or other similar #accessory buildings or other structures# for domestic or agricultural storage, with a height not exceeding 10 feet above the level of the #rear yard# or #rear yard equivalent#;~~
- (9) ~~Solar energy systems on the roof of a #building# permitted as an obstruction to such #yard#, up to four feet in height as measured perpendicular to the roof surface when located above a permitted #community facility# #use# or attached parking structure; however, limited to 18 inches in height as measured perpendicular to the roof surface when located above a shed or detached parking structure, or on any roof with a slope greater than 20 degrees;~~
- (10) ~~Water conserving devices required in connection with air conditioning or refrigeration systems in #buildings# existing prior to May 20, 1966, if located not less than eight feet from any #lot line#.~~

However, no portion of a #rear yard equivalent# which is also a required #front yard# or required #side yard# may contain any obstructions not permitted in such #front yard# or #side yard#.

\* \* \*

**24-35  
Minimum Required Side Yards**

R1 R2 R3 R4 R5

(a) In the districts indicated, if a #building# containing a #community facility# #use# has an #aggregate width of street walls# equal to 80 feet or less or, for #abutting# #buildings#, if the combined #aggregate width of street walls# of all such #abutting# #buildings# on a #zoning lot# is equal to 80 feet or less, then two #side yards# shall be provided, each with a minimum required width of eight feet. If such #building# or #buildings# have an #aggregate width of street walls# equal to more than 80 feet, two #side yards# shall be provided, each equal to not less than 10 percent of the #aggregate width of street walls#. The provisions of this paragraph (a) shall not apply in R5D Districts. In lieu thereof, the #side yard# regulations set forth in Sections 23-461 and 23-462, as applicable, shall apply.

R6 R7 R8 R9 R10

(b) In the districts indicated, no #side yards# are required. However, if any open area extending along a #side lot line# is provided at any level, it shall be at least eight feet wide. ~~Permitted obstructions pursuant to paragraph (a) of~~ The allowances for permitted obstructions in any #yard# or #rear yard equivalent# set forth in Section 24-33 (Permitted Obstructions in Required Yards or Rear Yard Equivalents) shall be permitted in such open areas.

\* \* \*

**24-50  
HEIGHT AND SETBACK REGULATIONS**

\* \* \*

**24-51  
Permitted Obstructions**

In all #Residence Districts#, the obstructions set forth in Section 23-621 (General permitted obstruction allowances), as well as the following obstructions, shall be permitted and may thus penetrate a maximum height limit or #sky exposure plane# set forth in Sections 24-52 (Maximum Height of Walls and Required Setbacks), 24-53 (Alternate Front Setbacks) or 24-591 (Limited Height Districts):

[REPETITIVE OBSTRUCTIONS BEING ELIMINATED  
AND REFERENCE MADE TO ONE GLOBAL REFERENCE]

- (a) ~~Awnings and other sun control devices, provided that when located at a level higher than the first #story#, excluding a #basement#, all such awnings and other sun control devices:~~
  - (1) ~~shall be limited to a maximum projection from a #building# wall of 2 feet, 6 inches, except when located on the first #story# above a setback;~~
  - (2) ~~shall have solid surfaces that, in aggregate, cover an area no more than 30 percent of the area of the #building# wall (as viewed in elevation) from which they project; and~~
  - (3) ~~may rise above the permitted #building# height, up to the height of a parapet wall or guardrail permitted in accordance with Section 23-62 (Permitted Obstructions);~~

When located on the first #story# above a setback, awnings and other sun control devices shall be limited to a projection of 50 percent of the depth of the required setback, and shall be limited, in total, to 50 percent of the width of the #building# wall from which they project;

- (b) (a) Balconies, unenclosed, subject to the provisions of Section 24-166;
- (c) #Building# columns, having an aggregate width equal to not more than 20 percent of the #aggregate width of street walls# of a #building#, to a depth not exceeding 12 inches, in an #initial setback distance#, optional front open area, or any other required setback distance or open area set forth in Sections 24-52, 24-53 or 24-54 (Tower Regulations);
- (d) Chimneys or flues, with a total width not exceeding 10 percent of the #aggregate width of street walls# of a #building# at any level;
- (e) Decks, and other surfaces for recreational activities, not more than 3 feet, 6 inches in height, as measured from the maximum height limit, or the finished level of the roof as it existed on April 30, 2012, whichever is higher;
- (f) Elevator or stair bulkheads (including shafts; and vestibules not larger than 60 square feet in area providing access to a roof), roof water tanks and #accessory# mechanical equipment (including enclosures), other than solar or wind energy systems, provided that:
  - (1) such obstructions shall be located not less than 10 feet from the #street wall# of a #building#, except that such obstructions need not be set back more than 25 feet from a #narrow street line# or more than 20 feet from a #wide street line#. However, such restrictions on location shall not apply to elevator or stair bulkheads (including shafts or vestibules), provided the #aggregate width of street walls# of such bulkheads within 10 feet of a #street wall#, facing each #street# frontage, times their average height, in feet, does not exceed an area equal to four feet times the width, in feet, of the #street wall# of the #building# facing such frontage;
  - (2) all mechanical equipment shall be screened on all sides;
  - (3) such obstructions and screening are contained within a volume that complies with one of the following:
    - (i) the product, in square feet, of the #aggregate width of street walls# of such obstructions facing each #street# frontage, times their average height, shall not exceed an area equal to eight feet times the width, in feet, of the #street wall# of the #building# facing such frontage; or
    - (ii) the #lot coverage# of all such obstructions does not exceed 20 percent of the #lot coverage# of the #building#, and where the maximum permitted height of a #building# is less than 120 feet, such obstructions are limited to a maximum height of 25 feet, and where the maximum permitted height of a #building# is 120 feet or greater, such obstructions are limited to a maximum height of 40 feet.

For the purposes of this paragraph (f), #abutting# #buildings# on a single #zoning lot# may be considered to be a single #building#;

- (b) (b) Elevator or stair bulkheads (including shafts; and vestibules not larger than 60 square feet in area providing access to a roof), roof water tanks, #energy infrastructure equipment#, and #accessory#

mechanical equipment (including enclosures), other than solar or wind energy systems (whether #accessory# or as part of #energy infrastructure equipment#), provided that:

- (1) such obstructions shall be located not less than 10 feet from the #street wall# of a #building#, except that such obstructions need not be set back more than 25 feet from a #narrow# #street line# or more than 20 feet from a #wide# #street line#. However, such restrictions on location shall not apply to elevator or stair bulkheads (including shafts or vestibules), provided the #aggregate width of street walls# of such bulkheads within 10 feet of a #street wall#, facing each #street# frontage, does not exceed 30 percent of the #street wall# width of the #building# facing such frontage;
  - (2) the aggregate area of such obstructions, including any required screening, does not exceed 50 percent of the #lot coverage# of the #building#;
  - (3) the height of obstructions within an aggregate area equivalent to at least 20 percent of the #lot coverage# of the #building# shall not exceed 15 feet above the maximum permitted height;
  - (4) the height of obstructions within the remaining #lot coverage#, not to exceed 30 percent of the #building# shall not exceed:
    - (i) where the maximum permitted height of a #building# is 120 feet or lower, a height of 35 feet above the maximum permitted height;
    - (ii) where the maximum permitted height of a #building# is greater than 120 feet, a height of 55 feet above the maximum permitted height; and
  - (5) all equipment shall be subject to the applicable provisions of Section 26-60 (SPECIAL SCREENING AND ENCLOSURE PROVISIONS);
- ~~(g) Exterior wall thickness, up to eight inches, where such wall thickness is added to the exterior face of a #building# wall existing on April 30, 2012, provided the added wall thickness has a thermal resistance (R-value) of at least 1.5 per inch. Where #buildings# that have added exterior wall thickness pursuant to this Section are #enlarged#, such #enlarged# portion may similarly penetrate a maximum height limit in order to align with the exterior walls of the existing #building#, provided such #enlargement# contains less #floor area# than the existing #building#, and there is no penetration of #floor area# above a maximum height limit;~~
- (h) Flagpoles or aerials;
- ~~(i)(c)~~ House of worship towers, ornamental, having no #floor area# in portion of tower penetrating such height limit or #sky exposure plane#;
- (j) Parapet walls, not more than four feet in height, as measured from the maximum height limit, or the finished level of the roof as it existed on April 30, 2012, whichever is higher. A guardrail with a surface at least 70 percent open or with an opacity of not more than 30 percent (as viewed in elevation), shall be permitted above a parapet wall or within two feet of a parapet wall, provided such guardrail is not more than four feet above the accessible level of a roof. Such restriction on guardrail height shall not apply when located beyond two feet from a parapet wall;
- (k) Roof thickness, up to eight inches, to accommodate the addition of insulation, for #buildings# or portions of #buildings# constructed prior to April 30, 2012. For a #building# that has added roof thickness pursuant to this paragraph, (k), an #enlargement# may align with the finished roof surface of

such ~~#building#~~, provided the ~~#enlarged#~~ portion does not exceed the maximum height limit by more than eight inches;

~~(d)~~ (d) ~~#Qualifying Rooftop greenhouses#, up to 25 feet in height, provided that such obstruction shall be located not less than six feet from the #street wall# of the #building#; , permitted pursuant to Section 75-01 (Certification for Rooftop Greenhouses);~~

~~(m)~~ Skylights, clerestories or other daylighting devices, not more than four feet in height, as measured from the maximum height limit, or the finished level of the roof as it existed on April 30, 2012, whichever is higher. Such devices shall be limited to a ~~#lot coverage#~~ not greater than 10 percent of the ~~#lot coverage#~~ of the roof and be located at least eight feet from the ~~#street wall#~~ edge. However, such devices shall not be permitted obstructions above a roof with a slope greater than 20 degrees;

~~(n)~~ Solar energy systems:

~~(1)~~ — on the roof of a ~~#building#~~, up to four feet in height, as measured from the maximum height limit, or the finished level of the roof, whichever is higher;

~~(2)~~ — on the roof of a ~~#building#~~, greater than four feet in height, as measured from the maximum height limit, or the finished level of the roof, whichever is higher, provided that all such portions above four feet are set back at least six feet from a ~~#street wall#~~, limited to a ~~#lot coverage#~~ not greater than 25 percent of the ~~#lot coverage#~~ of the roof and do not exceed:

~~(i)~~ — in R1 through R5 Districts, a height of six feet;

~~(ii)~~ — in R6 through R10 Districts, a height of 15 feet; and

~~(iii)~~ — when located on a bulkhead or other obstruction pursuant to paragraph (f) of this Section, a height of six feet;

~~(3)~~ — on walls existing on April 30, 2012, projecting no more than 10 inches and occupying no more than 20 percent of the surface area of the ~~#building#~~ wall (as viewed in elevation) from which it projects;

However, any installation on a roof with a slope greater than 20 degrees shall be limited to 18 inches in height, as measured perpendicular to the roof surface;

~~(e)~~ (e) Spires or belfries;

~~(p)~~ Vegetated roofs, not more than 3 feet, 6 inches in height, excluding vegetation, as measured from the maximum height limit, or the finished level of the roof as it existed on April 30, 2012, whichever is higher. On roofs with slopes greater than 20 degrees, vegetated roofs shall be limited to a height of 12 inches measured perpendicular to such roof surface;

~~(q)~~ Weirs, check dams and other equipment for stormwater management, not more than 3 feet, 6 inches in height, as measured from the maximum height limit, or the finished level of the roof as it existed on April 30, 2012, whichever is higher;

~~(f)~~ (f) Wind energy systems, ~~#accessory#~~ or as part of ~~#energy infrastructure equipment#~~, on portions of ~~#buildings#~~ with a height of 100 feet or greater, provided:

(1) the highest point of the wind turbine assembly does not exceed 55 feet;

- (2) no portion of the wind turbine assembly is closer than 10 feet to any #lot line#; and
- (3) the diameter of the swept area of the rotor does not exceed 15 feet;

~~(e) Window washing equipment mounted on a roof;~~

~~(f) Wire, chain link or other transparent fences.~~

\* \* \*

**24-55  
Required Side and Rear Setbacks**

R1 R2 R3 R4 R5 R6 R7 R8 R9 R10

In all districts, as indicated, side and rear setbacks shall be provided as specified in this Section. Unenclosed balconies, subject to the provisions of Section 24-166 (Balconies); and awnings and other sun control devices, decks, ~~exterior wall thickness #qualifying exterior wall thickness#~~, parapet walls, roof thickness, solar energy systems up to four feet high, vegetated roofs, and weirs, as set forth in Section 24-51 (Permitted Obstructions), are permitted to project into or over any open areas required by the provisions of this Section.

\* \* \*

**24-60  
COURT REGULATIONS AND MINIMUM DISTANCE BETWEEN WINDOWS AND WALLS OR LOT LINES**

\* \* \*

**24-65  
Minimum Distance Between Required Windows and Walls or Lot Lines**

R1 R2 R3 R4 R5 R6 R7 R8 R9 R10

In all districts, as indicated, the minimum distance between required windows and walls or #lot lines# shall be as set forth in this Section, except that this Section shall not apply to required windows in #buildings# of three #stories# or less. ~~For #buildings# existing on April 30, 2012, the minimum distances set forth in this Section, and any #non-complying# distance greater than eight feet, may be reduced by up to eight inches of exterior wall thickness from each #building# wall, provided the added wall thickness has a thermal resistance (R-value) of at least 1.5 per inch. A #non-complying# distance of eight feet or less shall be limited to a total reduction of one inch of wall thickness for each foot of such existing distance between buildings.~~

\* \* \*

**24-68  
Permitted Obstructions in Courts**

R1 R2 R3 R4 R5 R6 R7 R8 R9 R10

In all districts, as indicated, the obstructions permitted for any #yard# set forth in paragraph (a) of Section 23-441 (General permitted obstruction allowances), as well as the following, shall not be considered obstructions when located within a #court#. For the purposes of applying such allowances to #courts#, all percentage calculations shall be applied to the area of the #court# instead of the #yard# :

- (a) ~~Arbors or trellises;~~
- (b) ~~Awnings and other sun control devices. However, when located at a level higher than the first #story#, excluding a #basement#, all such devices:
 
  - (1) ~~shall be limited to a maximum projection from a #building# wall of 2 feet, 6 inches; and~~
  - (2) ~~shall have solid surfaces that, in aggregate, cover an area no more than 30 percent of the area of the #building# wall (as viewed in elevation) from which they project;~~~~
- (c) ~~Eaves, gutters, downspouts, window sills or similar projections, extending into such #court# not more than four inches;~~
- (d) ~~Exterior wall thickness, where such wall thickness is added to the exterior face of a #building# wall existing on April 30, 2012, provided the added wall thickness has a thermal resistance (R value) of at least 1.5 per inch, and is limited to one inch of thickness for every foot of existing #court# width, up to a maximum thickness of eight inches;~~

~~Where #buildings# that have added exterior wall thickness pursuant to this Section are #enlarged#, such #enlarged# portion may similarly encroach upon required #courts# in order to align with the exterior walls of the existing #building#, provided such #enlargement# contains less #floor area# than the existing #building#, and there is no encroachment of #floor area# into a required #court#;~~

- (e)(a) ~~Fences;~~
- (f)(b) ~~Fire escapes in #inner courts#, where such fire escapes are required as a result of alterations in #buildings# existing before December 15, 1961;~~
  - ~~Fire escapes in #outer courts#;~~
  - ~~Fire escapes in #outer court recesses#, not more than five feet in depth;~~
  - ~~Fire escapes in #outer court recesses#, more than five feet in depth, where such fire escapes are required as a result of alterations in #buildings# existing before December 15, 1961;~~
- (g) ~~Flagpoles;~~
- (c) ~~#Energy infrastructure equipment# and #accessory# mechanical equipment, subject to the requirements set forth in Section 23-442;~~

[MOVING SCREENING PROVISIONS TO SECTION 26-60]

- (h) ~~#Accessory# power systems, including, but not limited to, generators, solar energy systems, fuel cells, batteries and other energy storage systems, provided that:
 
  - (1) ~~all equipment shall be subject to the following location, enclosure, and screening requirements, as applicable:
 
    - (i) ~~all generators and cogeneration equipment shall be completely enclosed within a #building or other structure#, except as necessary for mechanical ventilation;~~~~~~

- (ii) ~~all other types of equipment may be unenclosed, provided that such equipment is located at least five feet from any #lot line#. However, if the area bounding all such equipment, as drawn by a rectangle from its outermost perimeter in plan view, exceeds 25 square feet, the entirety of such equipment shall be screened on all sides. Such screening may be opaque or perforated, provided that where perforated materials are provided, not more than 50 percent of the face is open; and~~
- (iii) ~~where any equipment at the ground floor level is located between a #street wall#, or prolongation thereof, and a #street line#, the entire width of such portion of the equipment facing a #street#, whether open or enclosed, shall be fully screened by vegetation; and~~
- (2) ~~the size of all equipment, including any screening or portions of any #building or other structure# enclosing such equipment, shall not exceed:~~
  - (i) ~~an area equivalent to 25 percent of any #court# containing #legally required windows#;~~
  - (ii) ~~in R1 through R5 Districts, a height of 10 feet above the lowest level of such #court#; and~~
  - (iii) ~~in R6 through R10 Districts, a height of 15 feet above the lowest level of such #court#;~~
- (d) ~~Recreational or yard drying equipment;~~
- (e) ~~Steps, and ramps or lifts for people with physical disabilities;~~
- (k) ~~Solar energy systems on walls existing on April 30, 2012, projecting no more than 10 inches and occupying no more than 20 percent of the surface area of the #building# wall (as viewed in elevation) from which it projects;~~
- (l) ~~Terraces, open, porches or steps.~~

In addition, for #courts# at a level higher than the first #story#, decks, skylights, parapet walls, roof thickness, solar energy systems up to four feet high, vegetated roofs, and weirs, as set forth in Section 24-51 (Permitted Obstructions), shall be permitted.

\* \* \*

**Chapter 5  
Accessory Off-street Parking and Loading Regulations**

\* \* \*

**25-40  
RESTRICTIONS ON OPERATION OF ACCESSORY OFF-STREET PARKING SPACES**

**25-41  
Purpose of Spaces and Rental to Non-Residents**



R1 R2 R3 R4 R5 R6 R7 R8 R9 R10

In all districts, as indicated, all permitted or required off-street parking spaces, open or enclosed, which are #accessory# to #residences# shall comply with the provisions of this Section.

#### 25-411

##### In R1 or R2 Districts

R1 R2

In the districts indicated, such spaces shall be designed and operated exclusively for the long-term storage of the private passenger motor vehicles used by the occupants of such #residences#.

#### 25-412

##### In all other Residence Districts

R3 R4 R5 R6 R7 R8 R9 R10

In the districts indicated, such spaces shall be designed and operated primarily for the long-term storage of the private passenger motor vehicles used by the occupants of such #residences#, except as set forth in this Section.

~~However, such spaces may be:~~

- (a) ~~#Accessory# off-street parking spaces may be rented for periods of not less than one week and not more than one month to persons who are not occupants of the #residences# to which such spaces are #accessory# for the accommodation of the private passenger motor vehicles used by such non-residents, provided that such spaces are operated in accordance with the regulations promulgated by the Commissioner of Buildings, in a manner which will not adversely affect the residential character of the neighborhood; or~~
- (b) ~~In R3-2 through R10 Districts, other than R4-1, R4A, R4B and R5A Districts, up to five spaces or 20 percent of all #accessory# off-street parking spaces, whichever is greater, may be allocated to publicly available electric vehicle charging facilities, or #car sharing vehicles#.~~

~~occupied by #car sharing vehicles#, provided that:~~

- (1) ~~in R3-2 and R4 Districts, except R4-1, R4A and R4B Districts, the number of spaces occupied by #car sharing vehicles# shall not exceed 10 percent of all spaces in a #group parking facility# that contains 20 or more spaces; and~~
- (2) ~~in R5, R6, R7, R8, R9 and R10 Districts, except R5A Districts, the number of spaces occupied by #car sharing vehicles# shall not exceed five spaces or 20 percent of all #accessory# off-street parking spaces, whichever is greater.~~

Such spaces provided pursuant to paragraphs (a) and (b) of this Section shall be made available to the occupants of the #residences# to which they are #accessory# within 30 days after written request is made to the landlord.

**25-42****Use of Spaces Accessory to Permitted Non-Residential Uses**

R1 R2 R3 R4 R5 R6 R7 R8 R9 R10

In all districts, as indicated, all permitted or required off-street parking spaces, open or enclosed, which are ~~#accessory#~~ to permitted non-~~#residential uses#~~ shall be used only by occupants, visitors, customers or employees of such ~~#uses#~~ and shall not be rented, except as set forth in this Section.

- (a) ~~except as may be #Accessory#~~ off-street parking spaces provided for houses of worship may be shared pursuant to Section 25-542 (Shared parking facilities for houses of worship).
- (b) ~~However, #car sharing vehicles# may occupy such spaces only pursuant to the provisions of paragraphs (a) and (b) of this Section. In R3-2 through R10 Districts, other than other than R4-1, R4A, R4B and R5A Districts, up to five spaces or 20 percent of all #accessory# off-street parking spaces, whichever is greater, may be allocated to publicly available electric vehicle charging facilities, or #car sharing vehicles#.~~

R1 R2 R3 R4 R5A

- (a) ~~In the districts indicated, #car sharing vehicles# may occupy parking spaces #accessory# to a non-#residential use# in a #group parking facility# containing 20 spaces or more that is #accessory# to a college or university #use# listed in Use Group 3; however, the number of spaces so occupied shall not exceed 10 percent of all parking spaces in such #group parking facility#.~~

R5 R5B R5D R6 R7 R8 R9 R10

- (b) ~~In the districts indicated, except R5A Districts, #car sharing vehicles# may occupy parking spaces #accessory# to a non-#residential use# in a #group parking facility# containing 20 spaces or more; however, the number of spaces so occupied shall not exceed 10 percent of all parking spaces in such #group parking facility#.~~

**25-43****Restrictions on Automotive Repairs and Sale of Motor Fuel**

R1 R2 R3 R4 R5 R6 R7 R8 R9 R10

In all districts, as indicated, automotive repairs or the sale of motor fuel, motor oil or automotive accessories are not permitted, except as provided in this Section in specified districts.

**25-431****Limited repairs ~~or motor fuel sales~~ permitted in specified districts**

R3 R4 R5 R6 R7 R8 R9 R10

In the districts indicated, within a #completely enclosed# garage, #detached# from a #building# containing #residences# and containing not less than 150 #accessory# off-street parking spaces, minor automotive repairs (not including body work) are permitted, ~~and not more than three motor fuel pumps may be provided.~~ However, ~~no motor fuel shall be sold to persons who are not using the parking spaces.~~

**25-44**  
**Electric Vehicle Charging**

Electric vehicle charging facilities shall be permitted at all #accessory# off-street parking spaces. Such charging shall be for the owners, occupants, employees, customers, residents or visitors using such #accessory# parking spaces, except as otherwise permitted by the provisions of Section 25-412 (In all other Residence Districts) or 25-42 (Use of Spaces Accessory to Permitted Non-Residential Uses).

\* \* \*

**25-60**  
**ADDITIONAL REGULATIONS FOR PERMITTED OR REQUIRED ACCESSORY OFF-STREET PARKING SPACES**

\* \* \*

**25-62**  
**Size and Location of Spaces**

R1 R2 R3 R4 R5 R6 R7 R8 R9 R10

(a) Minimum maneuvering space

In all districts, as indicated, for all #accessory# off-street parking spaces, open or enclosed, each 300 square feet of unobstructed standing or maneuvering area shall be considered one parking space, except as follows:

(1) Standard attended facilities

~~However, an~~ An area of less than 300 square feet, but in no event less than 200 square feet, may be considered as one space, where the layout and design of the parking area are adequate to permit convenient access and maneuvering in accordance with regulations promulgated by the Commissioner of Buildings, or where the developer or applicant for a building permit or certificate of occupancy certifies that such spaces will be fully attended.

In any case where a reduction of the required area per parking space is permitted on the basis of the developer's certification that such spaces will be fully attended, it shall be set forth in the certificate of occupancy that paid attendants employed by the owners or operators of such spaces shall be available to handle the parking and moving of automobiles at all times when such spaces are in use.

(2) Attended facilities with parking lift systems

For portions of an attended parking facility with parking lift systems, each individually lifted tray upon which a vehicle is stored shall be considered one parking space. Any other attended space not on a lifted tray shall be subject to the provisions of paragraph (a)(1) of this Section.

(3) #Automated parking facilities#

For #automated parking facilities#, each tray upon which a vehicle is stored shall constitute one parking space. The term “tray” shall refer to the structural support for vehicle storage in both pallet and non-pallet vehicle storage systems.

However, auxiliary parking trays in #automated parking facilities# may be exempted from constituting a parking space where the Commissioner of Buildings determines that such auxiliary parking trays are necessary to store and retrieve vehicles for the efficient operation of such #automated parking facility#.

(b) Driveway access

Driveways used to access required parking spaces must be unobstructed for a width of at least eight feet and a height of eight feet above grade and, if connecting to a #street#, such driveway may only be accessed by a curb cut.

~~In any case where a reduction of the required area per parking space is permitted on the basis of the developer's certification that such spaces will be fully attended, it shall be set forth in the certificate of occupancy that paid attendants employed by the owners or operators of such spaces shall be available to handle the parking and moving of automobiles at all times when such spaces are in use.~~

(c) Minimum size for each parking space

In no event shall the dimensions of any parking stall be less than 18 feet long and 8 feet, 6 inches wide.

However, the width of a parking stall may be reduced to eight feet for #detached#, #semi-detached# or #zero lot line buildings# on a #zoning lot# where not more than four #accessory# parking spaces are required if such #accessory# parking spaces are located in a #side lot ribbon# and are subject to the provisions of Section 25-621 (Location of parking spaces in certain districts).

(d) Special rules for certain areas

In the Borough of Staten Island and in #lower density growth management areas# in Community District 10, Borough of the Bronx, for #community facility# #uses#, each required parking space in a parking area not within a #building# shall be within a parking stall accessed from a travel aisle, where each such stall and aisle complies with the maneuverability standards of paragraph (b) of Section 36-58 (Parking Lot Maneuverability and Curb Cut Regulations). The use of an attendant shall be permitted only where necessary to accommodate additional, non-required parking spaces within the travel aisles. For such open parking areas with 18 or more spaces, or greater than 6,000 square feet in area, the provisions of Section 37-90 (PARKING LOTS) shall also apply.

\* \* \*

**25-626****Calculating floor area in parking facilities with lift systems, or in automated parking facilities**

For enclosed #accessory# off-street parking facilities, for the purposes of determining #floor area# in an #automated parking facility#, or an attended parking facility with parking lift systems, each tray upon which a vehicle is stored at a height that exceeds the permitted exemption set forth in the definition of #floor area# in

Section 12-10, or as otherwise modified in this Resolution, shall be considered #floor area# in an amount of 153 square feet, or the size of such lifted tray, whichever is greater.

\* \* \*

**25-65  
Surfacing**

R1 R2 R3 R4 R5 R6 R7 R8 R9 R10

In all districts, as indicated, all open off-street parking spaces shall be surfaced with permeable paving materials, asphaltic or Portland cement concrete, or other hard-surfaced dustless material, ~~at least four inches thick, except that where required parking spaces are located in #side lot ribbons#, hard surface ribbons may be permitted. However, permeable paving materials may be used in open parking areas where the Commissioner of Buildings determines that such materials are appropriate.~~

\* \* \*

**25-68  
For Parking Facilities Containing Car Sharing Vehicles**

R1 R2 R3 R4 R5 R6 R7 R8 R9 R10

Within an off-street parking facility that contains #car sharing vehicles#, an information plaque shall be placed within 20 feet of either the entrance to the parking facility or the attendant’s station, at a location accessible to and visible to users of such facility. The plaque shall be fully opaque, non-reflective and constructed of permanent, highly durable materials and shall contain the following statements in lettering no less than one inch high:

- (a) “Total parking spaces in facility:” which shall specify the total number of parking spaces permitted within such parking facility;
- (b) “Maximum number of car sharing vehicles:” which shall specify the total number of #car sharing vehicles# permitted within such parking facility; and
- (c) where such parking facility contains #accessory residential# parking spaces, “Accessory residential parking spaces shall be made available to residents of this building within 30 days after a written request is made to the landlord.”

\* \* \*

**25-70  
OFF-STREET LOADING REGULATIONS**

\* \* \*

**25-76  
Surfacing**

R1 R2 R3 R4 R5 R6 R7 R8 R9 R10

In all districts, as indicated, all permitted or required open off-street loading berths shall be surfaced with permeable paving materials, asphaltic or Portland cement concrete, or other hard-surfaced dustless material, at least six inches thick.

\* \* \*

**25-80  
BICYCLE PARKING**

\* \* \*

**25-83  
Restrictions on Operation, Size and Location of Enclosed Bicycle Parking Spaces**

R1 R2 R3 R4 R5 R6 R7 R8 R9 R10

In all districts, as indicated, all #accessory# bicycle parking spaces shall be provided on the same #zoning lot# as the #building# or #use# to which such spaces are #accessory#, except as provided in Section 25-84 (~~Certification for Off-site Bicycle Parking Spaces~~).

\* \* \*

**25-84  
~~Certification for Off-site Bicycle Parking Spaces~~**

R1 R2 R3 R4 R5 R6 R7 R8 R9 R10

In all districts, as indicated, ~~for colleges, universities, seminaries, hospitals and related facilities, except animal hospitals,~~ #accessory# bicycle parking spaces required pursuant to Section 25-811 (Enclosed bicycle parking spaces) may be provided on a #zoning lot# other than the same #zoning lot# as the #use# to which such spaces are #accessory#, provided that ~~the Chairperson of the City Planning Commission certifies to the Department of Buildings that all~~ such bicycle parking spaces are:

- (a) ~~located on a #zoning lot# not further than 1,000 feet from the nearest boundary of the #zoning lot# occupied by the #use# to which they are #accessory#, or within a subsurface parking and other service facility that serves multiple #zoning lots#, including the #zoning lot# occupied by the #use# to which they are #accessory#; and,~~
- (b) ~~subject to deed restrictions filed in an office of record, binding the owner and his heirs and assigns to maintain the required number of spaces as accessible throughout the life of the #use# generating the #accessory# bicycle parking spaces.~~

A plaque shall be placed within 30 feet of a #building# entrance, with lettering at least three-quarter inches in height stating “Bicycle Parking” followed by information directing users to the address of the off-site location.

The number of off-site #accessory# bicycle parking spaces provided pursuant to this Section and the area of such bicycle parking spaces, in square feet, shall be noted on the certificate of occupancy for both the #building# in which the off-site bicycle parking spaces are located, and the #building# containing the #use# to which such bicycle parking spaces are #accessory#.

\* \* \*

**25-85**

**Floor Area Exemption**

\* \* \*

However, in no event shall this Section apply to #single-# or #two-family residences# and in no event shall this Section apply to #accessory# bicycle parking spaces provided off-site pursuant to Section 25-84 (~~Certification for~~ Off-site Bicycle Parking Spaces).

\* \* \*

**Chapter 6  
Special Urban Design Regulations**

**26-00  
APPLICABILITY OF THIS CHAPTER**

The regulations of this Chapter shall apply:

\* \* \*

- (d) to #developments#, #enlargements# or #conversions# in all districts, as applicable, as set forth in Section 26-40 (STREET TREE PLANTING AND PLANTING STRIP REQUIREMENTS); ~~and~~
- (e) to #Quality Housing buildings# where supplemental ground floor level rules apply to #buildings# with #qualifying ground floors#, as set forth in Section 26-50 (SPECIAL GROUND FLOOR LEVEL PROVISIONS FOR QUALIFYING GROUND FLOORS)-; and
- (f) to all #energy infrastructure equipment# and #accessory# mechanical equipment not located within a #completely enclosed building#, as set forth in Section 26-60 (SPECIAL SCREENING AND ENCLOSURE PROVISIONS).

\* \* \*

**26-40  
STREET TREE PLANTING AND PLANTING STRIP REQUIREMENTS**

**26-41  
Street Tree Planting**

In accordance with applicability requirements of underlying district regulations, one #street# tree, pre-existing or newly planted, shall be provided for every 25 feet of #street# frontage of the #zoning lot#. Fractions equal to or greater than one-half resulting from this calculation shall be considered to be one tree.

- (a) Design criteria

Such #Street# trees shall be planted ~~at approximately equal intervals along the entire length of~~ along the curb of the #street# adjacent to the #zoning lot#, within:

- (1) tree beds or connected tree beds designed in compliance with standards set forth by the Department of Parks and Recreation; or
- (2) rain gardens designed in compliance with standards set forth by the Department of Environmental Protection.

For #zoning lots# with over 100 feet of #street# frontage, wherever two required #street# tree beds will be separated by less than 25 feet, such tree beds shall be combined and designed as a single continuous tree bed.

The species and caliper of all #street# trees shall be determined by the Department of Parks and Recreation, and all such trees shall be planted in accordance with the #street# tree planting standards of the Department of Parks and Recreation.

(b) Alternate compliance

~~Where the Department of Parks and Recreation determines that such tree planting would be infeasible adjacent to the #zoning lot#, or in historic districts where the Landmarks Preservation Commission determines that such tree planting would not be in character with the historic district such trees may be provided in an alternate manner, or waived, using any combination of provisions, as appropriate, set forth in this paragraph (b).~~

(1) Rain gardens

Where the Department of Parks and Recreation determines that such tree planting would be infeasible, such required #street# tree may be substituted for a rain garden designed in compliance with standards set forth by the Department of Environmental Protection.

(2) Planters

Where the Department of Parks and Recreation or Department of Transportation determines that below-grade infrastructure causes one or more tree planting location to be infeasible, such tree may be provided in permanent planters designed in compliance with standards set forth by the Department of Transportation.

(3) Off-site locations

~~such tree shall~~ Where the Department of Parks and Recreation determines that such tree planting would be infeasible, or in historic districts where the Landmarks Preservation Commission determines that such tree planting would not be in character with the historic district, one or more #street# trees may be planted in an alternative off-site location, to be selected by the Department of Parks and Recreation, except that if the Department of Parks and Recreation determines that no alternative location is available, or if no alternative location is provided within 30 days of an application for a Department of Parks and Recreation permit, such off-site tree shall be waived. Off-site trees shall be planted at alternative locations within:

- ~~(a)~~(i) an existing empty #street# tree pit or planting strip; or
- ~~(b)~~(ii) an unpaved area owned by the City of New York.

All such alternative locations shall be within the Community District or one-half mile of such #zoning lot#.



(4) Payment option

Where the Department of Parks and Recreation determines that such tree planting would be infeasible, or in historic districts where the Landmarks Preservation Commission determines that such tree planting would not be in character with the historic district, ~~in~~ in lieu of planting an off-site tree in an available alternative location, or in the event that planting adjacent to the #zoning lot# cannot be completed due to the season, funds equivalent to the cost of planting such tree, as established by rule of the Department of Parks and Recreation, may be deposited in an account of the City of New York. Such funds shall be dedicated to the planting of #street# trees by the City at an alternative location or, in the case of an off-season deposit, in front of the #zoning lot# at the next appropriate planting season.

~~The species and caliper of all #street# trees shall be determined by the Department of Parks and Recreation, and all such trees shall be planted in accordance with the #street# tree planting standards of the Department of Parks and Recreation.~~

\* \* \*

**26-60**  
**SPECIAL SCREENING AND ENCLOSURE PROVISIONS**

**26-61**  
**Special at-grade Screening and Enclosure Regulations**

In all districts, all #energy infrastructure equipment# and #accessory# mechanical equipment located below the rooftop level, other than solar or wind energy systems or equipment with a depth limited to 18 inches from an exterior wall, shall be subject to the following provisions when not located within a #completely enclosed building#, whether or not such equipment is located within a required #open space#, #yard#, or #court#:

[RELOCATING FROM PERMITTED OBSTRUCTIONS AND EXPANDING APPLICABILITY]

- (a) all generators and cogeneration equipment utilizing fossil fuels which are #accessory# to #buildings# other than #single-# or #two-family# #residences# shall be completely enclosed within a #building# or other structure#, except as necessary for mechanical ventilation;
- (b) all other types of equipment, including generators and cogeneration equipment serving #single-# or #two-family# #residences#, may be unenclosed, provided that such equipment is located at least five feet from any #lot line# and, where located between a #street wall# or prolongation thereof, and the #street line#, such equipment is within three feet of a #street wall#;
- (c) where the area bounding all such equipment, as drawn by a rectangle from its outermost perimeter in plan view, exceeds 25 square feet, such equipment shall be screened in its entirety on all sides. Such screening may be opaque or perforated, provided that where perforated materials are provided, not more than 50 percent of the face is open; and
- (d) where any equipment is located in a #front yard#, or is located within 15 feet of a #zoning lot line#, the equipment shall be fully screened from adjoining #zoning lots#, including such #zoning lots# situated across a #street#, by:

- (1) a wall or barrier or uniformly painted fence at least as tall as the equipment it is screening, and which must be at least 6 feet, but need not exceed 15 feet in height. Such wall, barrier or fence may be opaque or perforated, provided that not more than 50 percent of the face is open; and
- (2) a strip at least four feet wide and densely planted with vegetation that, at the time of planting are at least half as tall in height as the screen required by paragraph (1), and are of a type which may be expected to form a year-round dense screen at least six feet high within three years.

Such screening shall be maintained in good condition at all times, may be interrupted by normal entrances or exits and shall have no signs hung or attached thereto.

**26-62  
Special Rooftop Screening and Enclosure Regulations**

In all districts, all #energy infrastructure equipment# and #accessory# mechanical equipment located on roofs, other than solar energy systems, shall be subject to the following provisions when not located within a #completely enclosed building#, whether or not such equipment is penetrating a maximum height limit or a #sky exposure plane#.

All such equipment shall be screened on all sides. Such screening may be opaque or perforated, provided that where perforated materials are provided, not more than 50 percent of the face is open.

\* \* \*

**ARTICLE III  
COMMERCIAL DISTRICT REGULATIONS**

**Chapter 2  
Use Regulations**

**32-00  
GENERAL PROVISIONS**

In order to carry out the purposes and provisions of this Resolution, the #uses# of #buildings or other structures# and the open #uses# of #zoning lots#, or portions thereof, have been classified and combined into Use Groups. A brief statement is inserted at the start of each Use Group to describe and clarify the basic characteristics of that Use Group. Use Groups 1, 2, 3, 4, 5, 6, 7, 8, 9, 10, 11, 12, 13, 14, 15 and 16, including each #use# listed separately therein, are permitted in #Commercial Districts# as indicated in Sections 32-11 through 32-25, except that any such #use# which is also an #adult establishment# shall, in addition, be subject to the provisions of Section 32-01 (Special Provisions for Adult Establishments). For the purposes of establishing permitted #uses# in this Resolution, references to permitted #uses# in the Use Groups, or any sub-categories therein, shall include all #accessory# #uses# thereto.

\* \* \*

**32-10  
USES PERMITTED AS-OF-RIGHT**

\* \* \*

**32-15**  
**Use Group 6**

C1 C2 C4 C5 C6 C8

Use Group 6 consists primarily of retail stores and personal service establishments which:

- (1) provide for a wide variety of local consumer needs; and
- (2) have a small service area and are, therefore, distributed widely throughout the City.

Public service establishments serving small areas are also included. Retail and service establishments are listed in two subgroups, both of which are permitted in all C1 Districts.

The #uses# listed in subgroup A are also permitted within a #large-scale residential development# to provide daily convenience shopping for its residents.

\* \* \*

D. Public Service Establishments<sup>5</sup>

\* \* \*

Public utility stations for oil or gas metering or regulating<sup>1</sup>

~~Solar energy systems~~

\* \* \*

E. Clubs

Non-commercial clubs, without restrictions on activities or facilities [PRC-D]

F. Special infrastructure

Electric vehicle charging and battery swapping, open or enclosed

#Energy infrastructure equipment#, open or enclosed, with no size limitations, and subject to the provisions of Section 37-20 (SPECIAL SCREENING AND ENCLOSURE PROVISIONS)

Public bicycle and micromobility parking, open or enclosed

Recycling, or organic material, receiving, limited to 5,000 square feet per establishment

G. #Accessory# #uses#

\* \* \*

**32-16**  
**Use Group 7**

C2 C6\* C8

Use Group 7 consists primarily of home maintenance or repair services which:

- (1) fulfill recurrent needs of residents in nearby areas;
- (2) have a relatively small service area and are, therefore, widely distributed throughout the City; and
- (3) are incompatible in primary retail districts since they break the continuity of retail frontage.

\* \* \*

D. Auto Service Establishments

Automobile glass and mirror shops [PRC-B1]

Automobile seat cover or convertible top establishments, selling or installation [PRC-B1]

[MOVING TO USE GROUP 6]

~~Electric vehicle charging stations and automotive battery swapping facilities [PRC-B1]~~

Tire sales establishments, including installation services [PRC-B1]

\* \* \*

**32-17**

**Use Group 8**

\* \* \*

C. Automotive Service Establishments

\* \* \*

~~#Public parking garages# or #public parking lots# with a capacity of 150 spaces or less, subject to the provisions set forth for #accessory# off street parking spaces in Sections 36-53 (Width of Curb Cuts and Location of Access to the Street), 36-55 (Surfacing) and 36-56 (Screening), and provided that such #public parking lots# are not permitted as of right in C6-1A Districts and such #public parking garages# are not permitted as of right in C2-5, C2-6, C2-7, C2-8, C4-5, C4-5A, C4-5X, C4-6, C4-7, C6, C8-4, M1-4, M1-5, M1-6, M2-3, M2-4 or M3-2 Districts. #Public parking garages# may be open or enclosed, provided that no portion of such #use# shall be located on a roof other than a roof which is immediately above a #cellar# or #basement#.~~

#Public parking garages# and #public parking lots# shall be subject to select provisions set forth in Article III, Chapter 6. In the #Manhattan Core#, these #uses# are subject to the provisions of Article I, Chapter 3, and in the #Long Island City area#, as defined in Section 16-02 (Definitions), such #uses# are subject to the provisions of Article I, Chapter 6.

\* \* \*

**32-23**

**Use Group 14**

C2 C3 C7 C8

Use Group 14 consists of the special services and facilities required for boating and related activities.

\* \* \*

B. Clubs

Non-commercial clubs, without restrictions on activities or facilities [PRC-D]

C. Special infrastructure

Electric vehicle charging and battery swapping, open or enclosed

#Energy infrastructure equipment#, open or enclosed, with no size limitations, and subject to the provisions of Section 37-20 (SPECIAL SCREENING AND ENCLOSURE PROVISIONS)

Public bicycle and micromobility parking, open or enclosed

Recycling, or organic material, receiving, limited to 5,000 square feet per establishment

D. #Accessory# #uses#

\* \* \*

**32-40  
SUPPLEMENTARY USE REGULATIONS**

**32-41  
Enclosure Within Buildings**

C1 C2 C3 C4 C5 C6 C8

In the districts indicated, except as otherwise specifically provided in the Use Groups permitted in such districts and in Sections 36-11 (General Provisions) and 36-61 (Permitted Accessory Off-street Loading Berths), all permitted #uses# which are created by #development#, or which are #enlarged# or #extended#, or which result from a change of #use# shall be subject to the provisions of this Section with respect to enclosure within #buildings#. With respect to the #enlargement# or #extension# of an existing #use#, such provisions shall apply to the #enlarged# or #extended# portion of such #use#.

#Accessory# #uses# may be open or enclosed, notwithstanding any limitations on the principal #use#, provided that any open #accessory# #uses# are customarily found in connection with such principal #use#.

\* \* \*

**32-42  
Location Within Buildings**

**32-421  
Limitation on floors occupied by commercial uses**

C1 C2 C3

In the districts indicated, in any #building#, or portion of a #building# occupied on one or more of its upper #stories# by #residential# #uses# or by #community facility# #uses#, no #commercial# #uses# listed in Use Group 6A through 6E, 7, 8, ~~9 or~~, 14A or 14B shall be located above the level of the first #story# ceiling, provided, however, that permitted #signs#, other than #advertising signs#, #accessory# to such #commercial# #uses# may extend to a maximum height of two feet above the level of the finished floor of the second #story#, but in no event higher than six inches below the lowest window sill of the second #story#. In any other #building#, or portion thereof, not more than two #stories# may be occupied by #commercial# #uses# listed in Use Group 6A, 6B, 6C, ~~6E~~, 7, 8, ~~9 or~~, 14A or 14B.

However, in C1 or C2 Districts mapped within R9 or R10 Districts or in C1-8, C1-9, C2-7 or C2-8 Districts, non-#residential# #uses# listed in Use Group 6A through 6E, 7, 8, 9 or 14, where permitted by the applicable district regulations, may occupy the lowest two #stories# in any #building# constructed after September 17, 1970. For #buildings# constructed in such districts prior to September 17, 1970, located in Community District 6 in the Borough of Manhattan, such non-#residential# #uses# may occupy the lowest two #stories# in such #building#, provided that:

- (a) the Chairperson of the City Planning Commission certifies to the Commissioner of Buildings that the second #story# has not been occupied by a #community facility# #use#, a #dwelling unit# or a #rooming unit#, notwithstanding the certificate of occupancy, if any, for a continuous period from May 1, 2013, until a certification has been issued pursuant to this Section; and
- (b) the second #story# of at least one other #building# on the same #block# frontage is occupied by a #use# listed in such Use Groups 6, 7, 8, 9 or 14.

#Accessory# mechanical equipment serving #commercial# #uses# listed in such Use Groups shall not be subject to the location restrictions of this Section.

**32-422  
Location of floors occupied by commercial uses**

C4 C5 C6

In the districts indicated, in any #building#, or portion of a #building# occupied by #residential# #uses#, #commercial# #uses# listed in Use Group 5, 6A through 6E, 7, 8, 9, 10, 11, 12, 13, 14, 15 or 16 may be located only on a #story# below the lowest #story# occupied in whole or in part by such #dwelling units# or #rooming units#, except that this limitation shall not preclude the location of any such #commercial# #use# below the level of the first #story# ceiling, or the extension of a permitted #sign#, other than an #advertising sign#, #accessory# to such #commercial# #use#, to a maximum height of two feet above the level of the finished floor of the second #story#, but in no event higher than six inches below the lowest window sill on the second #story#.

#Accessory# mechanical equipment serving #commercial# #uses# listed in such Use Groups shall not be subject to the location restrictions of this Section.

**32-43  
Ground Floor Use in Certain Locations**

\* \* \*

**32-435  
Ground floor use in high density Commercial Districts**

The regulations of this Section shall apply to any #development# occupied by #predominantly# #residential use#, constructed after April 21, 1977, located on any #zoning lot# within C1-8, C1-9, C2-7, C2-8, C4-6, C4-7, C5-1, C5-2, C5-4, C6-3, C6-4, C6-5 or C6-8 Districts, or C1 or C2 Districts mapped within R9 or R10 Districts. However, this Section shall not apply within any Special Purpose District nor shall it apply to any #Quality Housing building#, except as otherwise set forth herein.

\* \* \*

(c) Retail Continuity

For #buildings# with front #building# walls that are at least 50 feet in width and front upon a #wide street#, a minimum of 50 percent of the width of such front #building# wall shall be occupied at the ground floor level by #commercial# #uses#, as permitted by district regulations.

In C1-8, C1-9, C2-7, C2-8 and C4-6 Districts and C1 or C2 Districts mapped within R9 or R10 Districts, #uses# which occupy such 50 percent of the front #building# wall shall be limited to those listed in Use Groups 6A, ~~and 6C and 6F~~, excluding banks and loan offices, except that in C4-6 Districts only, such #uses# may additionally include those listed in Use Groups 8A, 8B and 10A. All #uses# permitted by the underlying district regulations are permitted in the remaining 50 percent of the front #building# wall.

\* \* \*

**Chapter 3  
Bulk Regulations for Commercial or Community Facility Buildings in Commercial Districts**

**33-00  
APPLICABILITY, DEFINITIONS AND GENERAL PROVISIONS**

\* \* \*

**33-04  
Lower Density Growth Management Areas**

For areas designated as #lower density growth management areas#, pursuant to Section 12-10 (DEFINITIONS), the underlying district regulations shall apply. Such regulations are superseded or supplemented as set forth in the following Sections:

\* \* \*

Section 37-10 ~~(APPLICABILITY OF ARTICLE II, CHAPTER 6, TO LOTS WITH PRIVATE ROADS)~~  
(SPECIAL REGULATIONS FOR PRIVATE ROADS AND LOWER DENSITY GROWTH MANAGEMENT AREAS)

~~Section 37-20 (SPECIAL REGULATIONS FOR LOWER DENSITY GROWTH MANAGEMENT AREAS IN THE BOROUGH OF STATEN ISLAND); inclusive~~

Section 73-125 (Ambulatory diagnostic or treatment health care facilities)

\* \* \*

**33-20  
YARD REGULATIONS**

\* \* \*

**33-23  
Permitted Obstructions in Required Yards or Rear Yard Equivalents**

In all #Commercial Districts#, the obstructions set forth in Section 23-441 (General permitted obstruction allowances), as well as the following obstructions, shall be permitted when located within a required #yard# or #rear yard equivalent#:

[REPETITIVE OBSTRUCTIONS BEING ELIMINTATED AND REFERENCE MADE TO ONE GLOBAL REFERENCE]

(a) In any #yard# or #rear yard equivalent#:

- (1) ~~Arbors or trellises;~~
- (2) ~~Awnings and other sun control devices, provided that when located at a level higher than the first #story#, excluding a #basement#, all such awnings and other sun control devices:~~
  - (i) ~~shall be limited to a maximum projection from a #building# wall of 2 feet, 6 inches; and~~
  - (ii) ~~shall have solid surfaces that, in aggregate, cover an area no more than 30 percent of the area of the #building# wall (as viewed in elevation) from which they project;~~
- (3) ~~Canopies;~~
- (4) ~~Chimneys, projecting not more than three feet into, and not exceeding two percent of the area of, the required #yard# or #rear yard equivalent#;~~
- (5) ~~Eaves, gutters or downspouts, projecting into such #yard# or #rear yard equivalent# not more than 16 inches or 20 percent of the width of such #yard# or #rear yard equivalent#, whichever is the lesser distance;~~
- (6) ~~Exterior wall thickness, where such wall thickness is added to the exterior face of a #building# wall existing on April 30, 2012, provided the added wall thickness has a thermal resistance (R-value) of at least 1.5 per inch, and is limited to one inch of thickness for every foot of existing #yard# width, up to a maximum thickness of eight inches. When an open area is provided along a common #lot line#, then such exterior wall thickness is limited to one inch for every foot of existing open area on the #zoning lot#;~~

~~Where #buildings# that have added exterior wall thickness pursuant to this Section are #enlarged#, such #enlarged# portion may similarly encroach upon required #yards# in order~~



~~to align with the exterior walls of the existing #building#, provided such #enlargement# contains less #floor area# than the existing #building#, and there is no encroachment of #floor area# into a required #yard#;~~

- ~~(7)(1)~~ Fences;
- ~~(8)~~ Flagpoles;
- ~~(9)(2)~~ Parking spaces for automobiles or bicycles, off-street, open, #accessory#;
- ~~(10)(3)~~ #Energy infrastructure equipment# and #accessory# mechanical equipment, provided that:
  - (i) all equipment shall be subject to the applicable provisions of Section 37-20 (SPECIAL SCREENING AND ENCLOSURE PROVISIONS); and
  - (ii) the height of all equipment shall not exceed a height of 23 feet above #curb level#;

~~#Accessory# power systems, including, but not limited to, generators, solar energy systems, fuel cells, batteries and other energy storage systems, provided that all equipment shall not exceed a height of 23 feet above #curb level#;~~
- ~~(11)~~ Solar energy systems on walls existing on April 30, 2012, projecting no more than 10 inches and occupying no more than 20 percent of the surface area of the #building# wall (as viewed in elevation) from which it projects;
- ~~(12)(4)~~ Steps, and ramps or lifts for people with physical disabilities;
- ~~(13)~~ Terraces or porches, open;
- ~~(14)(5)~~ Walls, not exceeding eight feet in height and not roofed or part of a #building#.
- (b) In any #rear yard# or #rear yard equivalent#:
  - (1) Balconies, unenclosed, subject to the provisions of Section 24-166;
  - ~~(2)~~ Breezeways;
  - ~~(3)(2)~~ Any #building# or portion of a #building# used for any permitted #use# other than #residences#, except that any portion of a #building# containing rooms used for living or sleeping purposes (other than a room in a hospital used for the care or treatment of patients) shall not be a permitted obstruction, and provided that the height of such #building# shall not exceed one #story#, excluding #basement#, nor in any event 23 feet above #curb level#. In addition, decks, parapet walls, roof thickness, skylights, vegetated roofs, and weirs, pursuant to Section 33-42 (Permitted Obstructions), shall be permitted above such a #building#, or portion thereof;
  - ~~(4)~~ Fire escapes;
  - ~~(5)(3)~~ Parking spaces for automobiles or bicycles, off-street, #accessory#, provided that the height of an #accessory# #building# used for such purposes and located in a required #rear yard# or #rear yard equivalent# shall not exceed 23 feet above #curb level#. In addition, decks, parapet walls, roof thickness, skylights, vegetated roofs, and weirs, as set forth in Section 33-42, shall be permitted above such an #accessory# #building#, or portion thereof; or

- (4) Solar energy systems affixed to solar canopies and located over parking spaces associated with #public parking lots#, automobile rental establishments, or commercial or public utility vehicle parking facilities, as permitted, provided that the height shall not exceed 15 feet above the level of the adjoining grade.
- (6) Solar energy systems:
  - (i) ~~on the roof of a #building# permitted as an obstruction to such #yard#, up to four feet in height as measured perpendicular to the roof surface when located above a permitted #commercial# or #community facility# #use# or attached parking structure;~~
  - (ii) ~~on the roof of a #building# permitted as an obstruction to such #yard#, shall be limited to 18 inches in height as measured perpendicular to the roof surface when located above a shed or detached parking structure, or on any roof with a slope greater than 20 degrees;~~
  - (iii) ~~on walls existing on April 30, 2012, projecting no more than 10 inches and occupying no more than 20 percent of the surface area of the #building# wall (as viewed in elevation) from which it projects;~~
- (7) ~~Water conserving devices required in connection with air conditioning or refrigeration systems in #buildings# existing prior to May 20, 1966, if located not less than eight feet from any #lot line#.~~

However, no portion of a #rear yard equivalent# that is also a required #front yard# or required #side yard# may contain any obstructions not permitted in such #front yard# or #side yard#.

\* \* \*

**33-25  
Minimum Required Side Yards**

C1 C2 C3 C4 C5 C6 C7 C8

In all districts, as indicated, no #side yards# are required. However, if an open area extending along a #side lot line# is provided at any level, it shall be either:

- (a) at least eight feet wide at every point; or
- (b) at least five feet wide at every point, with an average width of eight feet, such average being the mean of the width of the open area at its narrowest point and its width at its widest point, provided that:
  - (1) such widest point shall be on a #street line#;
  - (2) no portion of a #building# shall project beyond a straight line connecting such two points; and
  - (3) in the case of a #zoning lot# bounded by a #side lot line# extending from #street# to #street#, such average shall be computed and such open area shall be provided as though each half of such #side lot line# bounded a separate #zoning lot#.

~~Permitted obstructions pursuant to paragraph (a) of The allowances for permitted obstructions in any #yard# or #rear yard equivalent# set forth in Section 33-23 (Permitted Obstructions in Required Yards or Rear Yard Equivalents), shall be permitted in such open areas.~~

\* \* \*

**33-40  
HEIGHT AND SETBACK REGULATIONS**

\* \* \*

**33-42  
Permitted Obstructions**

In all #Commercial Districts#, ~~the obstructions set forth in Section 23-621 (General permitted obstruction allowances), as well as the following obstructions,~~ shall be permitted and may thus penetrate a maximum height limit or #sky exposure planes#, as set forth in Sections 33-43 (Maximum Height of Walls and Required Setbacks), 33-44 (Alternate Front Setbacks) or 33-491 (Limited Height Districts):

[REPETITIVE OBSTRUCTIONS BEING ELIMINTATED AND REFERENCE MADE TO ONE GLOBAL REGULATION]

- ~~(a) Awnings and other sun control devices, provided that when located at a level higher than the first #story#, excluding a #basement#, all such awnings and other sun control devices:
 
  - ~~(1) shall be limited to a maximum projection from a #building# wall of 2 feet, 6 inches, except when located on the first #story# above a setback;~~
  - ~~(2) shall have solid surfaces that, in aggregate, cover an area no more than 30 percent of the area of the #building# wall (as viewed in elevation) from which they project; and~~
  - ~~(3) may rise above the permitted #building# height, up to the height of a parapet wall or guardrail permitted in accordance with paragraph (j) of this Section.~~~~

~~When located on the first #story# above a setback, awnings and other sun control devices shall be limited to a projection of 50 percent of the depth of the required setback, and shall be limited, in total, to 50 percent of the width of the #building# wall from which they project;~~

- ~~(b) (a) Balconies, unenclosed, subject to the provisions of Section 24-166;~~
- ~~(c) #Building# columns, having an aggregate width equal to not more than 20 percent of the #aggregate width of street walls# of a #building#, to a depth not exceeding 12 inches, in an #initial setback distance#, optional front open area, or any other required setback distance or open area set forth in Sections 33-43, 33-44 or 33-45 (Tower Regulations);~~
- ~~(d) Chimneys or flues, with a total width not exceeding 10 percent of the #aggregate width of street walls# of a #building# at any given level;~~
- ~~(e) Decks, and other surfaces for recreational activities, not more than 3 feet, 6 inches in height, as measured from the maximum height limit, or the finished level of the roof as it existed on April 30, 2012, whichever is higher;~~

- (f) Elevator or stair bulkheads (including shafts; and vestibules not larger than 60 square feet in area providing access to a roof), roof water tanks and #accessory# mechanical equipment (including enclosures), other than solar or wind energy systems, provided that:
- (1) such obstructions shall be located not less than 10 feet from the #street wall# of a #building#, except that such obstructions need not be set back more than 25 feet from a #narrow street line# or more than 20 feet from a #wide street line#. However, such restrictions on location shall not apply to elevator or stair bulkheads (including shafts or vestibules), provided the #aggregate width of street walls# of such bulkheads within 10 feet of a #street wall#, facing each #street# frontage, times their average height, in feet, does not exceed an area equal to four times the width, in feet, of the #street wall# of the #building# facing such frontage;
  - (2) all mechanical equipment shall be screened on all sides;
  - (3) such obstructions and screening are contained within a volume that complies with one of the following:
    - (i) the product, in square feet, of the #aggregate width of street walls# of such obstructions facing each #street# frontage, times their average height, shall not exceed an area equal to eight times the width, in feet, of the #street wall# of the #building# facing such frontage; or
    - (ii) the #lot coverage# of all such obstructions does not exceed 20 percent of the #lot coverage# of the #building#, and where the maximum permitted height of a #building# is less than 120 feet, such obstructions are limited to a maximum height of 25 feet, and where the maximum permitted height of a #building# is 120 feet or greater, such obstructions are limited to a maximum height of 40 feet.

For the purposes of this paragraph, (f), #abutting# #buildings# on a single #zoning lot# may be considered to be a single #building#;

- (b) Elevator or stair bulkheads (including shafts; and vestibules not larger than 60 square feet in area providing access to a roof), roof water tanks, #energy infrastructure equipment#, and #accessory# mechanical equipment (including enclosures), other than solar or wind energy systems (whether #accessory# or as part of #energy infrastructure equipment#), provided that:
- (1) such obstructions shall be located not less than 10 feet from the #street wall# of a #building#, except that such obstructions need not be set back more than 25 feet from a #narrow# #street line# or more than 20 feet from a #wide# #street line#. However, such restrictions on location shall not apply to elevator or stair bulkheads (including shafts or vestibules), provided the #aggregate width of street walls# of such bulkheads within 10 feet of a #street wall#, facing each #street# frontage, does not exceed 30 percent of the #street wall# width of the #building# facing such frontage;
  - (2) the aggregate area of such obstructions, including any required screening, does not exceed 50 percent of the #lot coverage# of the #building#;
  - (3) the height of obstructions within an aggregate area equivalent to at least 20 percent of the #lot coverage# of the #building# shall not exceed 15 feet above the maximum permitted height; and
  - (4) the height of obstructions within the remaining #lot coverage#, not to exceed 30 percent of the #building#, shall not exceed;

- (i) where the maximum permitted height of a #building# is 120 feet or lower, a height of 35 feet above the maximum permitted height;
- (ii) where the maximum permitted height of a #building# is greater than 120 feet, a height of 55 feet above the maximum permitted height; and
- (5) all equipment shall be subject to the applicable provisions of Section 37-20 (SPECIAL SCREENING AND ENCLOSURE PROVISIONS);
- (g) ~~Exterior wall thickness, up to eight inches, where such wall thickness is added to the exterior face of a #building# wall existing on April 30, 2012, provided the added wall thickness has a thermal resistance (R-value) of at least 1.5 per inch. Where #buildings# that have added exterior wall thickness pursuant to this Section are #enlarged#, such #enlarged# portion may similarly penetrate a maximum height limit in order to align with the exterior walls of the existing #building#, provided such #enlargement# contains less #floor area# than the existing #building#, and there is no penetration of #floor area# above a maximum height limit;~~
- (h) ~~Flagpoles or aerials;~~
- (i) ~~House of worship towers, ornamental, having no #floor area# in portion of tower penetrating such height limit or #sky exposure plane#;~~
- (j) ~~Parapet walls, not more than four feet in height, as measured from the maximum height limit, or the finished level of the roof as it existed on April 30, 2012, whichever is higher. A guardrail with a surface at least 70 percent open or with an opacity of not more than 30 percent (as viewed in elevation), shall be permitted above a parapet wall or within two feet of a parapet wall, provided such guardrail is not more than four feet above the accessible level of a roof. Such restriction on guardrail height shall not apply when located beyond two feet from a parapet wall;~~
- (k) ~~Roof thickness, up to eight inches, to accommodate the addition of insulation, for #buildings# or portions of #buildings# constructed prior to April 30, 2012. For a #building# that has added roof thickness pursuant to this paragraph, an #enlargement# may align with the finished roof surface of such #building#, provided the #enlarged# portion does not exceed the maximum height limit by more than eight inches;~~
- (l) ~~(d) #Qualifying Rooftop greenhouses#, up to 25 feet in height, provided that such obstruction shall be located not less than six feet from the #street wall# of the #building#; permitted pursuant to Section 75-01 (Certification for Rooftop Greenhouses);~~
- (m) ~~Skylights, clerestories or other daylighting devices, not more than four feet in height, as measured from the maximum height limit, or the finished level of the roof as it existed on April 30, 2012, whichever is higher. Such devices shall be limited to a #lot coverage# not greater than 10 percent of the #lot coverage# of the roof and be located at least eight feet from the #street wall# edge. However, such devices shall not be permitted obstructions above a roof with a slope greater than 20 degrees;~~
- (n) ~~Solar energy systems:~~
  - (1) ~~on the roof of a #building#, up to four feet in height, as measured from the maximum height limit, or the finished level of the roof, whichever is higher;~~
  - (2) ~~on the roof of a #building#, greater than four feet in height, as measured from the maximum height limit, or the finished level of the roof, whichever is higher, provided that all such~~

portions above four feet are set back at least six feet from a #street wall#, limited to a #lot coverage# not greater than 25 percent of the #lot coverage# of the roof and do not exceed:

- (i) in #Commercial Districts# mapped within R1 through R5 Districts and in C3 and C4-1 Districts, a height of six feet;
  - (ii) in all other #Commercial Districts# and #Commercial Districts# mapped within R6 through R10 Districts, a height of 15 feet; and
  - (iii) when located on a bulkhead or other obstruction pursuant to paragraph (f) of this Section, a height of six feet;
- (3) on walls existing on April 30, 2012, projecting no more than 10 inches and occupying no more than 20 percent of the surface area of the #building# wall (as viewed in elevation) from which it projects.

However, any installation on a roof with a slope greater than 20 degrees shall be limited to 18 inches in height, as measured perpendicular to the roof surface;

- (e) Spires or belfries;
- (p) Vegetated roofs, not more than 3 feet, 6 inches in height, excluding vegetation, as measured from the maximum height limit, or the finished level of the roof as it existed on April 30, 2012, whichever is higher. On roofs with slopes greater than 20 degrees, vegetated roofs shall be limited to a height of 12 inches measured perpendicular to such roof surface;
- (q) Weirs, check dams and other equipment for stormwater management, not more than 3 feet, 6 inches in height, as measured from the maximum height limit, or the finished level of the roof as it existed on April 30, 2012, whichever is higher;
- (f) Wind energy systems, #accessory# or as part of #energy infrastructure equipment#, on portions of #buildings# with a height of 100 feet or greater, provided that:
  - (1) the highest point of the wind turbine assembly does not exceed 55 feet;
  - (2) no portion of the wind turbine assembly is closer than 10 feet to any #lot line#; and
  - (3) in districts where new #residences# or new #joint living-work quarters for artists# are allowed as-of-right or by special permit or authorization, or within 100 feet of such districts, the diameter of the swept area of the rotor does not exceed 15 feet;
- (s) Window washing equipment mounted on a roof;
- (t) Wire, chain link or other transparent fences.

\* \* \*

**33-43  
Maximum Height of Walls and Required Setbacks**

\* \* \*

**33-431  
In C1 or C2 Districts with bulk governed by surrounding Residence District**

C1-1 C1-2 C1-3 C1-4 C1-5 C2-1 C2-2 C2-3 C2-4 C2-5

In the districts indicated, for #buildings# other than #Quality Housing buildings#, the maximum height of a front wall and the required front setback of a #building or other structure# shall be determined by the #Residence District# within which such #Commercial District# is mapped and, except as otherwise set forth in this Section, shall be as set forth in the following table:

\* \* \*

However, in accordance with the provisions of Section 32-42 (Location Within Buildings), no #commercial building# or portion thereof occupied by non-#residential uses# listed in Use Groups 6A, 6B, 6C, ~~6F~~, 7, 8, 9, ~~or 14A or 14B~~ shall exceed in height 30 feet or two #stories#, whichever is less.

\* \* \*

**33-432  
In other Commercial Districts**

C1-6 C1-7 C1-8 C1-9 C2-6 C2-7 C2-8 C3 C4 C5 C6 C7 C8

\* \* \*

However, in accordance with the provisions of Section 32-42 (Location within Buildings), in C1, C2 or C3 Districts, no #commercial building#, or portion thereof, occupied by non-#residential uses# listed in Use Group 6A, 6B, 6C, ~~6F~~, 7, 8, 9, ~~or 14A or 14B~~ shall exceed in height 30 feet or two #stories#, whichever is less.

\* \* \*

**33-44  
Alternate Front Setbacks**

\* \* \*

**33-441  
In C1 or C2 Districts with bulk governed by surrounding Residence District**

C1-1 C1-2 C1-3 C1-4 C1-5 C2-1 C2-2 C2-3 C2-4 C2-5

In the districts indicated, the alternate front setback regulations applicable to a #building or other structure# shall be determined by the #Residence District# in which such #Commercial District# is mapped and, except as otherwise set forth in this Section, shall be as set forth in the following table:

\* \* \*

However, in accordance with the provisions of Section 32-42 (Location within Buildings), no #commercial building#, or portion thereof, occupied by non-#residential uses# listed in Use Group 6A, 6B, 6C, ~~6F~~, 7, 8, 9, ~~or 14A or 14B~~ shall exceed in height 30 feet or two #stories#, whichever is less.

\* \* \*

**33-442**

**In other Commercial Districts**

C1-6 C1-7 C1-8 C1-9 C2-6 C2-7 C2-8 C3 C4 C5 C6 C7 C8

In the districts indicated, the alternate front setback regulations applicable to a #building or other structure# shall be as set forth in the following table:

\* \* \*

However, in accordance with the provisions of Section 32-42 (Location Within Buildings), in C1, C2 or C3 Districts, no #commercial building# or portion thereof occupied by #uses# listed in Use Group 6A, 6B, 6C, ~~6E~~, 7, 8, 9, ~~or 14A or 14B~~ shall exceed in height 30 feet or two #stories#, whichever is less.

\* \* \*

**Chapter 4**

**Bulk Regulations for Residential Buildings in Commercial Districts**

\* \* \*

**34-20**

**EXCEPTIONS TO APPLICABILITY OF RESIDENCE DISTRICT CONTROLS**

\* \* \*

**34-23**

**Modification of Yard Regulations**

\* \* \*

**34-232**

**Modification of side yard requirements**

C1 C2 C3 C4 C5 C6

In the districts indicated, except as otherwise provided in Section 34-233 (Special provisions applying along district boundaries), no #side yard# shall be required for any #residential building#. However, if any open area extending along a #side lot line# is provided, such open area shall have a width of not less than eight feet. ~~Permitted obstructions, pursuant to paragraph (a) of~~ The allowances for permitted obstructions in any #yard# or #rear yard equivalent# set forth in Section 23-44 (Permitted Obstructions in Required Yards or Rear Yard Equivalents), inclusive, shall be permitted in such open areas.

\* \* \*

**Chapter 5**

**Bulk Regulations for Mixed Buildings in Commercial Districts**

\* \* \*

**35-50**

**MODIFICATION OF YARD REGULATIONS**



\* \* \*

**35-52  
Modification of Side Yard Requirements**

C1 C2 C3 C4 C5 C6

In the districts indicated, except as otherwise provided in Section 35-54 (Special Provisions Applying Adjacent to R1 Through R5 Districts), no #side yard# shall be required although, if any open area extending along a #side lot line# is provided at any level, it shall have a width of not less than eight feet. ~~Permitted obstructions, pursuant to paragraph (a) of~~ The allowances for permitted obstructions in any #yard# or #rear yard equivalent# set forth in Section 33-23 (Permitted Obstructions in Required Yards or Rear Yard Equivalents), shall be permitted in such open areas.

However, in C3A Districts, #side yards# shall be provided in accordance with the regulations for R3A Districts as set forth in Section 23-461 (Side yards for single- or two-family residences).

\* \* \*

**35-60  
MODIFICATION OF HEIGHT AND SETBACK REGULATIONS**

\* \* \*

**35-65  
Height and Setback Requirements for Quality Housing Buildings**

In all such districts, the permitted obstructions provisions of Section 33-42 shall apply to any #building or other structure#. In addition, a dormer may be allowed as a permitted obstruction pursuant to paragraph (c)(1) of Section ~~23-624~~ 23-623 (Permitted obstructions in certain districts).

\* \* \*

**35-653  
Tower regulations**

C6-3D C6-4X

In the districts indicated, any #building or other structure#, or portions thereof, which in the aggregate occupies not more than 40 percent of the #lot area# of a #zoning lot# or, for #zoning lots# of less than 20,000 square feet, the percentage set forth in the table in Section 23-65 (Tower Regulations), above a height of 85 feet above the #base plane#, is hereinafter referred to as a tower. Dormers permitted within a required setback area pursuant to Section ~~23-624~~ 23-623 (Permitted obstructions in certain districts) shall not be included in tower coverage. Such tower may exceed a height limit of 85 feet above the #base plane# provided the base of such tower complies with the applicable provisions of Section 35-651 (Street wall location) and the setback provisions of Section 35-652 (Maximum height of buildings and setback regulations), and provided that the tower portion complies with the provisions of paragraphs (a), (b) and (c) of Section 23-663 (Tower regulations).

\* \* \*

**Chapter 6  
Accessory Off-Street Parking and Loading Regulations**

**36-00  
GENERAL PURPOSES AND DEFINITIONS**

\* \* \*

**36-02  
Applicability of District Regulations**

Except as otherwise provided in this Section, the regulations of this Chapter on permitted and required #accessory# off-street parking spaces and #accessory# bicycle parking spaces apply to #residences#, #community facility# #uses# or #commercial# #uses#, as set forth in the provisions of the various Sections. In addition, the regulations of this Chapter, or of specified Sections thereof, also apply in other provisions of this Resolution where they are incorporated by cross reference. In limited instances certain regulations also apply to #public parking garages# and #public parking lots#.

\* \* \*

**36-029  
Applicability of regulations to public parking garages and public parking lots**

The following provisions of this Chapter shall apply to #public parking garages# and #public parking lots# in addition to #accessory# off-street parking facilities:

- Section 36-462      (Restrictions on the use of parking spaces in public parking garages and public parking lots)
- Section 36-524      (Calculating floor area in parking facilities with lift systems, or in automated parking facilities)
- Section 36-53        (Width of Curb Cuts and Location of Access to the Street)
- Section 36-55        (Surfacing)
- Section 36-56        (Screening)
- Section 36-58        (Parking Lot Maneuverability and Curb Cut Regulations)

**36-03  
Definitions**

\* \* \*

**36-40  
RESTRICTIONS ON LOCATION AND USE OF ACCESSORY OFF-STREET PARKING SPACES**

\* \* \*

**36-46  
Restrictions on the Use of Accessory Parking Spaces and Spaces in Public Parking Garages and Public Parking Lots**

**36-461****Restrictions on Use of Accessory Off-street Parking Spaces the use of accessory off-street parking spaces**

C1 C2 C3 C4 C5 C6 C7 C8

In all districts, as indicated, all permitted or required #accessory# off-street parking spaces, open or enclosed, shall be used primarily for the owners, occupants, employees, customers, residents or visitors of the #use# or #uses# to which such spaces are #accessory#, except as set forth in this Section.

- (a) Any off-street parking spaces #accessory# to #residences# which are not needed by the occupants of such #residences#, may be rented to persons who are not occupants of such #residences# for the accommodation of private passenger motor vehicles used by such persons, provided that:
- (1) in C1 and C5 Districts, such spaces shall not be rented for periods of less than one week or more than one month to persons who are not occupants of such #residences#, provided, however, that rental for shorter periods may be permitted by the Board of Standards and Appeals in accordance with the provisions of Section 73-47 (Rental of Accessory Off-street Parking Spaces to Non-Residents); and
  - (2) in C3 Districts, such spaces shall not be rented for periods of less than one week or more than one month to persons who are not occupants of such #residences#.
- (b) In C1 or C2 Districts mapped within, or with an equivalent of, R3-2 through R10 Districts, other than R4-1, R4A, R4B and R5A Districts, and in C3 Districts, up to five spaces or 20 percent of all #accessory# off-street parking spaces, whichever is greater, may be allocated to:
- (i) publicly available electric vehicle charging facilities;
  - (ii) #car sharing vehicles#; or
  - (iii) vehicles stored by automobile rental establishments.
- (c) In C4, C5, C6, C7 and C8 Districts, up to five spaces or 20 percent of all #accessory# off-street parking spaces, whichever is greater, may be allocated to:
- (i) publicly available electric vehicle charging facilities;
  - (ii) #car sharing vehicles#;
  - (iii) vehicles stored by automobile rental establishments; or
  - (iv) commercial or public utility vehicle parking for motor vehicles not exceeding a length of 20 feet.

Any spaces #accessory# to #residences# shall be made available to the occupants of the #residences# to which they are #accessory# within 30 days after written request is made to the landlord.

or may be occupied by #car sharing vehicles#, only as set forth in the following paragraphs:

(1) — In C1 or C2 Districts mapped within #Residence Districts#

In C1 or C2 Districts mapped within R3, R4 or R5A Districts, the number of spaces occupied by #car sharing vehicles# shall not exceed 10 percent of all parking spaces in #group parking facilities# containing 20 or more spaces. In C1 or C2 Districts mapped within R5 Districts, except R5A Districts, and in R6, R7, R8, R9 or R10 Districts, the number of spaces occupied by #car sharing vehicles# shall not exceed five spaces or 20 percent of all parking spaces, whichever is greater.

(2) — In C1 or C2 Districts not mapped within #Residence Districts#, or in C3, C4, C5, C6 Districts

In the districts indicated, except C3 Districts, the number of spaces occupied by #car sharing vehicles# shall not exceed five spaces or 20 percent of all parking spaces, whichever is greater. In C3 Districts, the number of spaces occupied by #car sharing vehicles# shall not exceed 10 percent of all parking spaces in #group parking facilities# containing 20 or more spaces.

Such spaces provided pursuant to paragraph (a) of this Section shall be made available to the occupants of the #residences# to which they are #accessory# within 30 days after written request is made to the landlord.

(b) — #Car sharing vehicles# may occupy off street parking spaces #accessory# to a non #residential use# in #group parking facilities# containing 20 spaces or more; however, the number of spaces so occupied shall not exceed 10 percent of all parking spaces in such #group parking facilities#.

In addition, the rental of such spaces to non residents shall be subject to the restrictions applying to the specified districts as set forth in Sections 36-461 and 36-462, except that such restrictions shall not apply to spaces occupied by #car sharing vehicles#.

### **36-461**

#### **Restrictions on rental of spaces accessory to residences in C1 or C5 Districts**

##### **C1-C5**

In the districts indicated, off street parking spaces #accessory# to #residences# shall not be rented for periods of less than one week or more than one month to persons who are not occupants of such #residences#, provided, however that rental for shorter periods may be permitted by the Board of Standards and Appeals in accordance with the provisions of Section 73-47 (Rental of Accessory Off street Parking Spaces to Non-Residents).

### **36-462**

#### **Restrictions on rental of spaces accessory to residences in C3 Districts**

##### **C3**

In the district indicated, off street parking spaces #accessory# to #residences# shall not be rented for periods of less than one week or more than one month to persons who are not occupants of such #residences#.

**36-462****Restrictions on the use of parking spaces in public parking garages and public parking lots**C1 C2 C3 C4 C5 C6 C7 C8

In all districts, as indicated, off-street parking spaces in #public parking garages# and #public parking lots# may be made available for electric charging, or allocated to #car sharing vehicles#, vehicles stored by automobile rental establishments, or commercial or public utility vehicle parking, only as follows:

- (a) In all districts, all spaces within a #public parking garage# or #public parking lot# may be allocated to publicly available electric vehicle charging facilities.
- (b) In C1 or C2 Districts mapped within, or with an equivalent of R3-2 through R10 Districts, other than R4-1, R4A, R4B and R5A Districts, and in C3 Districts, up to 50 percent of the parking spaces within a #public parking garage# or #public parking lot# may be allocated to #car sharing vehicles#, or vehicles stored by automobile rental establishments.
- (c) In C4, C5, C6, C7 and C8 Districts, up to 50 percent of the parking spaces within a #public parking garage# or #public parking lot# may be allocated to:
  - (i) #car sharing vehicles#;
  - (ii) vehicles stored by automobile rental establishments; or
  - (iii) commercial or public utility vehicle parking for motor vehicles not exceeding a length of 20 feet.

**36-47****Restrictions on Automotive Repairs and Sale of Motor Fuel**C1 C2 C3 C4 C5 C6 C7 C8

In all districts, as indicated, automotive repairs or the sale of motor fuel, motor oil or automotive accessories are not permitted in connection with the operation of #accessory# off-street parking spaces. However, where such parking spaces are provided in a #building or other structure#, unattached to the #building# containing #residences#, minor automotive repairs (not including body work) are permitted, ~~and not more than three motor fuel pumps may be provided. However, no motor fuel shall be sold to persons who are not using the parking spaces.~~ The provisions of this Section are not applicable to #accessory# off-street parking spaces provided in #public parking garages#.

**36-48****Electric Vehicle Charging**

Electric vehicle charging facilities shall be permitted at all #accessory# off-street parking spaces. Such charging shall be for the owners, occupants, employees, customers, residents or visitors using such #accessory# parking spaces, except as otherwise permitted by the provisions of Section 36-461 (Restrictions on use of accessory off-street parking spaces).

**36-50  
ADDITIONAL REGULATIONS FOR PERMITTED OR REQUIRED ACCESSORY OFF-STREET  
PARKING SPACES**

\* \* \*

**36-52  
Size, Location and Identification of Spaces**

C1 C2 C3 C4 C5 C6 C7 C8

In the districts indicated, all #accessory# off-street parking spaces shall comply with the size and location provisions of this Section.

**36-521  
Size of spaces**

C1 C2 C3 C4 C5 C6 C7 C8

(a) Minimum maneuvering space

In all districts, as indicated, for all #accessory# off-street parking spaces, open or enclosed, each 300 square feet of unobstructed standing or maneuvering area shall be considered one parking space, except as follows: ~~However, an~~

(1) Standard attended facilities

An area of less than 300 square feet, but in no event less than 200 square feet, may be considered as one space, where the layout and design of the parking area are adequate to permit convenient access and maneuvering in accordance with regulations promulgated by the Commissioner of Buildings, or where the developer or applicant for a building permit or certificate of occupancy certifies that such spaces will be fully attended.

[EXISTING TEXT BEING RELOCATED FROM BELOW]

In any case where a reduction of the required area per parking space is permitted on the basis of the developer's certification that such spaces will be fully attended, it shall be set forth in the certificate of occupancy that paid attendants employed by the owners or operators of such spaces shall be available to handle the parking and moving of automobiles at all times when such spaces are in use.

(2) Attended facilities with parking lift systems

For portions of an attended parking facility with parking lift systems, each individually lifted tray upon which a vehicle is stored shall be considered one parking space. Any other attended space not on a lifted tray shall be subject to the provisions of paragraph (a)(1) of this Section.

(3) #Automated parking facilities#

For #automated parking facilities#, each tray upon which a vehicle is stored shall constitute one street parking space. The term "tray" shall refer to the structural support for vehicle storage in both pallet and non-pallet vehicle storage systems.

However, auxiliary parking trays in #automated parking facilities# may be exempted from constituting a parking space where the Commissioner of Buildings determines that such auxiliary parking trays are necessary to store and retrieve vehicles for the efficient operation of such #automated parking facility#.

(b) Driveway access

Driveways used to access required parking spaces must be unobstructed for a width of at least eight feet and a height of eight feet above grade and, if connecting to a #street#, such driveway may only be accessed by a curb cut.

[EXISTING TEXT BEING RELOCATED ABOVE]

~~In any case where a reduction of the required area per parking space is permitted on the basis of the developer's certification that such spaces will be fully attended, it shall be set forth in the certificate of occupancy that paid attendants employed by the owners or operators of such spaces shall be available to handle the parking and moving of automobiles at all times when such spaces are in use.~~

(c) Minimum size for each parking space

In no event shall the dimensions of any parking stall be less than 18 feet long and 8 feet, 6 inches wide.

(d) Special rules for certain areas

In the Borough of Staten Island and in #lower density growth management areas# in Community District 10 in the Borough of the Bronx, for #commercial# or #community facility# #uses#, each required parking space not within a #building# shall be within a parking stall accessed from a travel aisle, where each such stall and aisle complies with the maneuverability standards of paragraph (b) of Section 36-58 (Parking Lot Maneuverability and Curb Cut Regulations). The use of an attendant shall be permitted only where necessary to accommodate additional, non-required parking spaces within the travel aisles. For such parking areas with 18 or more spaces, or greater than 6,000 square feet in area, the provisions of Section 37-90 (PARKING LOTS) shall also apply.

\* \* \*

**36-524**

**Calculating floor area in parking facilities with lift systems, or in automated parking facilities**

For enclosed #accessory# off-street parking facilities, or #public parking garages#, for the purposes of determining #floor area# in an #automated parking facility#, or an attended parking facility with parking lift systems, each tray upon which a vehicle is stored at a height that exceeds the permitted exemption set forth in the definition of #floor area# in Section 12-10, or as otherwise modified in this Resolution, as applicable, shall be considered #floor area# in an amount of 153 square feet, or the size of such lifted tray, whichever is greater.

\* \* \*

**36-55**

**Surfacing**

C1 C2 C3 C4 C5 C6 C7 C8

\* \* \*

Any area intended to be used permanently for an open #accessory# #group parking facility# shall be surfaced with permeable paving materials, asphaltic or Portland cement concrete, or other hard-surfaced dustless material, ~~at least four inches thick. However, permeable paving materials may be used in open parking areas where the Commissioner of Buildings determines that such materials are appropriate.~~

\* \* \*

**36-70  
BICYCLE PARKING**

\* \* \*

**36-73  
Restrictions on Operation, Size and Location of Bicycle Parking Spaces**

C1 C2 C3 C4 C5 C6 C7 C8

In all districts, as indicated, all #accessory# bicycle parking spaces shall be provided on the same #zoning lot# as the #building# or #use# to which such spaces are #accessory#, except as provided in Section 36-74 (~~Certification for Off-site Bicycle Parking Spaces~~).

\* \* \*

Bicycle spaces may be located in a room secured by a lock, or similar means, provided that access is through a commonly accessible area and access is made available to eligible users on an equal basis. Rooms containing required bicycle parking spaces may also contain non-required #accessory# bicycle spaces, as well as non-#accessory# bicycle spaces permitted by the underlying district regulations.

\* \* \*

**36-74  
~~Certification for Off-site Bicycle Parking Spaces~~**

C1 C2 C3 C4 C5 C6 C7 C8

In all districts, as indicated, ~~for colleges, universities, seminaries, hospitals and related facilities, except animal hospitals,~~ #accessory# bicycle parking spaces required pursuant to Section 36-711 (Enclosed bicycle parking spaces) may be provided on a #zoning lot# other than the same #zoning lot# as the #use# to which such spaces are #accessory#, provided that ~~the Chairperson of the City Planning Commission certifies to the Department of Buildings that all~~ such bicycle parking spaces are:

- ~~(a) —~~located on a #zoning lot# not further than 1,000 feet from the nearest boundary of the #zoning lot# occupied by the #use# to which they are #accessory#, or within a subsurface parking and other service facility that serves multiple #zoning lots#, including the #zoning lot# occupied by the #use# to which they are #accessory#; ~~and,~~
- ~~(b) —~~subject to deed restrictions filed in an office of record, binding the owner and his heirs and assigns to maintain the required number of spaces as accessible throughout the life of the #use# generating the #accessory# bicycle parking spaces.

A plaque shall be placed within 30 feet of an entrance of the #building#, with lettering at least three-



quarter inches in height stating “Bicycle Parking” followed by information directing users to the address of the off-site location.

The number of off-site #accessory# bicycle parking spaces provided pursuant to this Section and the area of such bicycle parking spaces, in square feet, shall be noted on the certificate of occupancy for both the #building# in which the off-site bicycle parking spaces are located, and the #building# containing the #use# to which such bicycle parking spaces are #accessory#.

\* \* \*

**36-75  
Floor Area Exemption**

\* \* \*

However, in no event shall this Section apply to #single-# or #two-family residences#; and in no event shall this Section apply to #accessory# bicycle parking spaces provided off-site, pursuant to Section 36-74 (~~Certification for~~ Off-site Bicycle Parking Spaces).

**Chapter 7  
Special Urban Design Regulations**

**37-00  
GENERAL PURPOSES**

Special urban design regulations are set forth in this Chapter to improve the quality of the streetscape and to promote a lively and engaging pedestrian experience along commercial streets in various neighborhoods.

The provisions of this Chapter shall apply as follows:

- (a) Section 37-10 sets forth applicability of Article II, Chapter 6 to zoning lots accessed by private roads ~~in C1 or C2 Districts mapped within R3, R4 or R5 Districts, and in C3 Districts; and sets forth special regulations for lower density growth management areas in the Borough of Staten Island;~~
- (b) ~~Section 37-20, inclusive, sets forth special regulations for lower density growth management areas in the Borough of Staten Island;~~  
Section 37-20, inclusive, sets forth special regulations for all energy infrastructure equipment and accessory mechanical equipment not located within a completely enclosed building;
- (c) Section 37-30, inclusive, sets forth special streetscape provisions that apply in conjunction with provisions specified in the supplemental use provisions of Article III, Chapter 2, special provisions for certain areas in Article VI, or in Special Purpose Districts in Articles VIII through XIV;
- (d) Section 37-40, inclusive, sets forth provisions for relocating or renovating subway stairs in certain areas;
- (e) Section 37-50, inclusive, sets forth requirements for pedestrian circulation spaces that apply in conjunction with provisions specified in certain Special Purpose Districts;

- (f) Section 37-60, inclusive, sets forth provisions for publicly accessible open areas such as plazas, residential plazas and urban plazas created prior to October 17, 2007;
- (g) Section 37-70, inclusive, sets forth provisions for public plazas;
- (h) Section 37-80 sets forth provisions for arcades; and
- (i) Section 37-90, inclusive, sets forth provisions for certain open parking areas, including landscaping.

### **37-10**

#### **APPLICABILITY OF ARTICLE II, CHAPTER 6, TO LOTS WITH PRIVATE ROADS SPECIAL REGULATIONS FOR PRIVATE ROADS AND LOWER DENSITY GROWTH MANAGEMENT AREAS**

### **37-11**

#### **Applicability of Article II, Chapter 6, to Lots with Private Roads**

In C1 or C2 Districts mapped within R3, R4 or R5 Districts, and in C3 Districts, the provisions of Section 26-20 (SPECIAL REQUIREMENTS FOR LOTS WITH PRIVATE ROADS) shall apply to any #zoning lot# with #buildings# accessed by #private roads#, except where such #zoning lot# contains #private roads# constructed prior to February 6, 2002. In addition, the open area between #buildings# and sidewalks required pursuant to Section 26-25 need not be planted where such open areas front upon #commercial# #uses#.

However, in C3A Districts located within #lower density growth management areas#, the provisions of 26-30 (SPECIAL REQUIREMENTS FOR LOTS WITH PRIVATE ROADS IN LOWER DENSITY GROWTH MANAGEMENT AREAS) shall apply.

### **37-12**

#### **Special Screening For Lower Density Growth Management Areas in Staten Island**

In all C1, C2 and C4-1 Districts in the Borough of Staten Island, all #developments# or #enlargements# containing non-#residential uses# shall be screened from adjoining #zoning lots# containing only #residential uses# by a planting strip at least five feet wide along the common #side lot line#, densely planted with evergreen shrubs at least four feet high at time of planting and of a variety expected to reach a height of six feet within three years. No chain link fences shall be permitted. However, no such screening shall be required where both such #buildings# front upon a #street line# that forms the boundary of a #block# front mapped entirely as a #Commercial District#.

### **37-20**

#### **SPECIAL REGULATIONS FOR LOWER DENSITY GROWTH MANAGEMENT AREAS IN THE BOROUGH OF STATEN ISLAND SPECIAL SCREENING AND ENCLOSURE PROVISIONS**

**37-21**

**Special Screening Requirements Between Residential and Non-Residential Uses  
Special At-grade Screening and Enclosure Regulations**

In all C1, C2 and C4-1 Districts in the Borough of Staten Island, all #developments# or #enlargements# containing non-#residential uses# shall be screened from adjoining #zoning lots# containing only #residential uses# by a planting strip at least five feet wide along the common #side lot line#, densely planted with evergreen shrubs at least four feet high at time of planting and of a variety expected to reach a height of six feet within three years. No chain link fences shall be permitted. However, no such screening shall be required where both such #buildings# front upon a #street line# that forms the boundary of a #block# front mapped entirely as a #Commercial District#.

In all districts, other than C8 Districts, all #energy infrastructure equipment# and #accessory# mechanical equipment located below the rooftop level, other than solar or wind energy systems or equipment with a depth limited to 18 inches from an exterior wall, shall be subject to the following provisions when not located within a #completely enclosed building#, whether or not such equipment is located within a required #open space#, #yard#, or #court#:

- (a) all generators and cogeneration equipment utilizing fossil fuels which are #accessory# to #buildings# other than #single-# or #two-family# #residences# shall be completely enclosed within a #building or other structure#, except as necessary for mechanical ventilation;
- (b) all other types of equipment, including generators and cogeneration equipment serving #single-# or #two-family# #residences#, may be unenclosed, provided that such equipment is located at least five feet from any #side# or #rear lot line# and where located between a #street wall#, or prolongation thereof, and the #street line#, such equipment is within three feet of a #street wall#; and
- (c) where the area bounding all such equipment, as drawn by a rectangle from its outermost perimeter in plan view, exceeds 25 square feet, such equipment shall be screened in its entirety on all sides. Such screening may be opaque or perforated, provided that where perforated materials are provided, not more than 50 percent of the face is open.

**37-22**

**Special Rooftop Screening and Enclosure Regulations**

In all districts, all #energy infrastructure equipment# and #accessory# mechanical equipment located on roofs, other than solar energy systems, shall be subject to the following provisions when not located within a #completely enclosed building#, whether or not such equipment is penetrating a maximum height limit or a #sky exposure plane#.

All such equipment shall be screened on all sides. Such screening may be opaque or perforated, provided that where perforated materials are provided, not more than 50 percent of the face is open.

**37-30**

**SPECIAL GROUND FLOOR LEVEL STREETScape PROVISIONS FOR CERTAIN AREAS**

\* \* \*

**37-50**

**REQUIREMENTS FOR PEDESTRIAN CIRCULATION SPACE**

\* \* \*

**37-53**

**Design Standards for Pedestrian Circulation Spaces**

(a) Arcade

\* \* \*

An arcade shall meet the following requirements:

\* \* \*

(3) Permitted obstructions

Except for #building# columns, and ~~exterior wall thickness~~ #qualifying exterior wall thickness# pursuant to Section 33-23 (Permitted Obstructions in Required Yards or Rear Yard Equivalents), an arcade shall be free from obstructions of any kind.

\* \* \*

(b) #Building# entrance recess area

\* \* \*

A #building# entrance recess area shall meet the following requirements:

\* \* \*

(2) Permitted obstructions

Any portion of a #building# entrance recess area under an overhanging portion of the #building# shall have a minimum clear height of 15 feet. It shall be free of obstructions except for ~~exterior wall thickness~~ #qualifying exterior wall thickness# pursuant to Section 33-23, and #building# columns, between any two of which there shall be a clear space of at least 15 feet measured parallel to the #street line#. Between a #building# column and a wall of the #building#, there shall be a clear path at least five feet in width.

\* \* \*

(c) Corner arcade

\* \* \*

A corner arcade shall meet the following requirements:

\* \* \*

(2) Permitted obstructions

Except for #building# columns, ~~exterior wall thickness~~ #qualifying exterior wall thickness# pursuant to Section 33-23, a corner arcade shall be free from obstructions of any kind.

\* \* \*

(d) Corner circulation space

\* \* \*

A corner circulation space shall meet the following requirements:

\* \* \*

(2) Permitted obstructions

A corner circulation space shall be completely open to the sky from its lowest level, except for temporary elements of weather protection, such as awnings or canopies, provided that the total area of such elements does not exceed 20 percent of the area of the corner circulation space and that such elements and any attachments thereto are at least eight feet above #curb level#. A corner circulation space shall be clear of all other obstructions including, without limitation, door swings, #building# columns, #street# trees, planters, vehicle storage, parking or trash storage. However, ~~exterior wall thickness~~ #qualifying exterior wall thickness# may be added pursuant to Section 33-23. No gratings, except for drainage, shall be permitted.

\* \* \*

(f) Sidewalk widening

\* \* \*

A sidewalk widening shall meet the following requirements:

\* \* \*

(3) Permitted obstructions

A sidewalk widening shall be unobstructed from its lowest level to the sky except for those obstructions permitted under paragraph (f)(2) of this Section, ~~exterior wall thickness~~ #qualifying exterior wall thickness# to Section 33-23, and for temporary elements of weather protection, such as awnings or canopies, provided that the total area of such elements, measured on the plan, does not exceed 20 percent of the sidewalk widening area, and that such elements and any attachments thereto are at least eight feet above #curb level#.

\* \* \*

(h) Through #block# connection

\* \* \*

A through #block# connection shall meet the following requirements:

\* \* \*

(2) Design standards for a through #block# connection

- (i) A through #block# connection shall provide a straight, continuous, unobstructed path at least 15 feet wide. If covered, the clear, unobstructed height of a through #block# connection shall not be less than 15 feet. ~~exterior wall thickness~~ #qualifying exterior wall thickness#, as set forth in Section 33-23, shall be a permitted obstruction to such path.

\* \* \*

**37-70  
PUBLIC PLAZAS**

\* \* \*

**37-72  
Access and Circulation**

\* \* \*

**37-721  
Sidewalk frontage**

To facilitate pedestrian access to a #public plaza#, the following rules shall apply to the area of the #public plaza# located within 15 feet of a #street line# or sidewalk widening line:

\* \* \*

- (b) In the remaining 50 percent of such area, only those obstructions listed in Section 37-726 (Permitted obstructions) shall be allowed, provided such obstructions are not higher than two feet above the level of the public sidewalk fronting the #public plaza#, except for light stanchions, public space signage, railings for steps, ~~exterior wall thickness~~ #qualifying exterior wall thickness# pursuant to Section 33-23 (Permitted Obstructions in Required Yards or Rear Yard Equivalents), trash receptacles, trees and fixed or moveable seating and tables. Furthermore, planting walls or trellises, water features and artwork may exceed a height of two feet when located within three feet of a wall bounding the #public plaza#.

\* \* \*

**37-726  
Permitted obstructions**

- (a) #Public plazas# shall be open to the sky and unobstructed except for the following features, equipment and appurtenances normally found in #public parks# and playgrounds: water features, including fountains, reflecting pools and waterfalls; sculptures and other works of art; seating, including benches, seats and moveable chairs; trees, planters, planting beds, lawns and other landscape features; arbors or trellises; litter receptacles; bicycle racks; tables and other outdoor furniture; lights and lighting stanchions; public telephones; public restrooms; permitted temporary exhibitions; permitted awnings, canopies or marquees; permitted freestanding #signs#; play equipment; ~~exterior wall thickness~~ #qualifying exterior wall thickness# added pursuant to Section 33-23 (Permitted Obstructions in Required Yards or Rear Yard Equivalents); permitted kiosks and open-air cafes; stages; subway station entrances, which may include escalators; and drinking fountains.

\* \* \*

(b) Permitted obstructions may occupy a maximum percentage of the area of a #public plaza#, as follows:

\* \* \*

Trees planted flush-to-grade in accordance with the provisions of Section 37-742 (Planting and trees) and tree canopies do not count as obstructions for the purpose of calculating total area occupied by permitted obstructions. Planting beds and their retaining walls for trees count as obstructions, except that lawn, turf or grass areas intended for public access and seating shall not count as obstructions, provided such lawns do not differ in elevation from the adjoining #public plaza# elevation by more than six inches. ~~exterior wall thickness~~ #qualifying exterior wall thickness# added pursuant to Section 33-23 in any #publicly accessible open area# or #public plaza# ~~built prior to April 30, 2012,~~ shall not count as obstructions for the purpose of calculating total area occupied by permitted obstructions.

\* \* \*

**37-90  
PARKING LOTS**

\* \* \*

**37-92  
Landscaping**

The provisions of Section 37-921 (Perimeter landscaping) shall apply to open #accessory# off-street parking facilities and #public parking lots# with 18 or more spaces or at least 6,000 square feet in area that front upon a #street#.

The provisions of Section 37-922 (Interior landscaping) shall additionally apply to open #accessory# off-street parking facilities and #public parking lots# with 36 or more spaces or at least 12,000 square feet in area.

However, where more than 75 percent of the parking spaces in such #accessory# off-street parking facility or #public parking lot# will be covered by solar canopies, the requirements of such Sections may be modified by the provisions of Section 37-923 (Alternative compliance for solar canopies).

**37-921  
Perimeter landscaping**

All open parking areas ~~subject to the provisions of this Section with 18 spaces or more or 6,000 square feet or more in area that front upon a #street#~~ shall be screened at the #street line# by a perimeter landscaped area at least seven feet in width measured perpendicular to the #street line#. Such perimeter landscaped area may be interrupted only by vehicular entrances and exits. Walkways may also traverse the perimeter landscaped area in order to provide a direct connection between the public sidewalk and a walkway within or adjacent to the open parking area. In the event a perimeter landscaped area is greater than seven feet in width, the first seven feet adjacent to the open parking area must comply with paragraphs (a) and (b) of this Section. The remainder of the landscaped perimeter area may comply with paragraphs (a) and (b) or be comprised of any combination of grass, groundcover, shrubs, trees or other living plant material.

\* \* \*

**37-922**

**Interior landscaping**

All open parking areas ~~subject to the provisions of this Section of 36 or more parking spaces or at least 12,000 square feet in area~~ shall provide at least one tree for every eight parking spaces. Fractions equal to or greater than one-half resulting from this calculation shall be considered to be one tree. Such trees shall be in addition to the trees required in the perimeter screening area. Each such tree shall have a minimum caliper of three inches and be located in a planting island with a minimum area of 150 square feet of pervious surface.

\* \* \*

**37-923**

**Alternative compliance for solar canopies**

For open parking areas where solar canopies will cover more than 75 percent of the parking spaces in an #accessory# off-street parking facility or #public parking lot#, or any portion thereof with more than 10 parking spaces, the provisions of Sections 37-921 or 37-922 may be modified as follows:

- (a) the tree planting requirements of paragraph (b)(3) of Section 37-921 (Perimeter landscaping) need not apply where a solar canopy is proposed within 10 feet of a portion of a perimeter landscaped area along a #street# frontage necessitating a tree; and
- (b) the interior landscaping requirements of Section 37-922 (Interior landscaping) need not apply to such portion covered by a solar canopy.

\* \* \*

**ARTICLE IV  
MANUFACTURING DISTRICT REGULATIONS**

**42-00  
GENERAL PROVISIONS**

In order to carry out the purposes and provisions of this Resolution, the #uses# of #buildings or other structures# and the open #uses# of #zoning lots#, or portions thereof, have been classified and combined into Use Groups. A brief statement is inserted at the start of each Use Group to describe and clarify the basic characteristics of that Use Group.

Use Groups 4B, ~~4C~~, 5, 6A, 6B, 7, 8, 9B, ~~9C~~, 10B, ~~10C~~, 11, 12A, 12C, 12D, ~~12E~~, 13, 14, 16, 17 or 18, including each #use# listed separately therein, and certain #uses# listed in Use Groups 3A, 4A, 6C, 9A, 10A or 12B are permitted in #Manufacturing Districts# as indicated in Sections 42-11 to 42-15, inclusive, except that any such #use# which is also an #adult establishment# shall, in addition, be subject to the provisions of Section 42-01 (Special Provisions for Adult Establishments).

\* \* \*

**42-10  
USES PERMITTED AS-OF-RIGHT**

\* \* \*

**42-11  
Use Groups 4A, 4B, ~~4C~~, 5, 6C, 6E, 7A, 9A and 12B**



M1

Use Groups 4B, ~~4C~~, 5, 6C, 6E, 7A, 9A and 12B as set forth in Sections 32-13, 32-14, 32-15, 32-16, 32-18, 32-21.

Use Group 4A shall be limited to all health facilities requiring approval under Article 28 of the Public Health Law of the State of New York that, prior to July 10, 1974, have received approval of Part I of the required application from the Commissioner of Health, ambulatory diagnostic or treatment health care facilities, as listed in Section 22-14 (Use Group 4), and houses of worship. Such #uses# are not subject to the special permit provisions of Sections 42-32 and 74-921.

\* \* \*

**42-12**

**Use Groups 3A, 6A, 6B, 6D, 6F, 7B, 7C, 7D, ~~7E~~, 8, 9B, 9C, 10A, 10B, ~~10C~~, 11, 12A, 12C, 12D, ~~12E~~, 13, 14 and 16**

M1 M2 M3

Use Group 3A shall be limited to museums that are ancillary to existing motion picture production studios or radio or television studios, provided they are located within 500 feet of such studios and do not exceed 75,000 square feet of #floor area#.

Use Groups 6A except that food stores, including supermarkets, grocery stores or delicatessen stores, shall be limited to 10,000 square feet of #floor area# per establishment, 6B, 6D, 6F, 7B, 7C, 7D, ~~7E~~, 8, 9B, 9C, 10A, 10B, ~~10C~~, 11, 12A, 12C, 12D, ~~12E~~, 13, 14 and 16 as set forth in Sections 32-15 to 32-23, inclusive, and Section 32-25. However, in Community District 1, in the Borough of the Bronx, in M1-4 Districts, food stores, including supermarkets, grocery stores or delicatessen stores, shall be limited to 30,000 square feet of #floor area# per establishment. In addition, the regulations of this Section are modified, where applicable, by the regulations of Section 63-11 (Special Use Regulations for FRESH Food Stores in M1 Districts).

\* \* \*

#Public parking garages# and #public parking lots# shall be subject to select provisions set forth in Article IV, Chapter 4. In the #Manhattan Core#, automobile rental establishments, #public parking garages# and #public parking lots# in Use Groups 8C and 12D are subject to the provisions of Article I, Chapter 3, and in the #Long Island City area#, as defined in Section 16-02 (Definitions), #public parking garages# and #public parking lots# in Use Groups 8C and 12D are subject to the provisions of Article I, Chapter 6.

\* \* \*

**42-14**

**Use Group 17**

M1 M2 M3

Use Group 17 consists primarily of #manufacturing# #uses# that:

- (1) can conform to high performance standards by controlling objectionable influences; and
- (2) in so doing, can limit their impact on adjacent residential areas; and

(3) normally generate a great deal of traffic, both pedestrian and freight.

\* \* \*

C. Miscellaneous #uses#

Agriculture, including greenhouses, nurseries or truck gardens

Composting, open or enclosed

Docks for passenger ocean vessels, other than #gambling vessels#

\* \* \*

D. Special #uses# in M1-5B Districts

M1-5B

\* \* \*

(2) #Commercial# and #manufacturing# #uses# below the floor level of the second #story# provided, in M1-5B Districts, in any #buildings#, only #uses# listed in Use Groups 7, 9, 11, 16, 17A, 17B; or 17C ~~or 17E~~ shall be allowed below the floor level of the second #story# of such #buildings# unless modified by the Chairperson of the City Planning Commission, pursuant to Sections 42-141 or 74-781;

\* \* \*

**42-141**

**Modification by certification of the Chairperson of the City Planning Commission of uses in M1-5B Districts**

In M1-5B Districts, the requirements of paragraphs D.(1)(b), D.(1)(c), D.(1)(d) and D.(1)(e) or D.(2) of Section 42-14 (Use Group 17) may be modified by certification of the Chairperson of the City Planning Commission as provided in this Section. A copy of any request for modification under this Section shall be sent by the applicant to the applicable Community Board at least 20 days prior to the next regularly scheduled Community Board meeting. If the Community Board elects to comment on such requests, it must do so within 31 days of such notification.

\* \* \*

(c) The provisions of paragraph D.(2) of Section 42-14 may be modified provided a #use# other than those listed in Use Groups 7, 9, 11, 16, 17A, 17B; or 17C ~~or 17E~~ occupied the #floor area# below the level of the second #story# as of September 1, 1980, and an application under this provision has been filed with the City Planning Commission not later than June 21, 1983.

\* \* \*

**42-15**

**Use Group 18**

M3

Use Group 18 consists primarily of industrial #uses# which:

- (1) either involve considerable danger of fire, explosion or other hazards to public health or safety, or cannot be designed without appreciable expense to conform to high performance standards with respect to the emission of objectionable influences; and
- (2) normally generate a great deal of traffic, both pedestrian and freight.

\* \* \*

**B. Storage or miscellaneous #uses#, open or enclosed**

Coal or gas storage

Dumps, recycling or material recovery facilities, marine transfer stations for garbage or slag piles

Electric power or steam generating plants

\* \* \*

**42-40  
SUPPLEMENTARY USE REGULATIONS AND SPECIAL PROVISIONS APPLYING ALONG  
DISTRICT BOUNDARIES**

\* \* \*

**42-41  
Enclosure of Commercial or Manufacturing Activities**

M1 M2 M3

In all districts, as indicated, all commercial or manufacturing activities established by #development#, #enlargement#, #extension# or change of #use#, except storage of materials or products, shall be subject to the provisions of this Section with respect to enclosure, except as otherwise specifically provided in the Use Groups permitted in the district, and in Sections 44-11 (General Provisions) and 44-51 (Permitted Accessory Off-street Loading Berths). With respect to the #enlargement# or #extension# of an existing #use#, such provisions shall apply to the #enlarged# or #extended# portion of such #use#.

#Accessory uses# may be open or enclosed, notwithstanding any limitations on the principal #use#, provided that any open #accessory uses# are customarily found in connection with such principal #use#.

\* \* \*

**Chapter 3  
Bulk Regulations**

\* \* \*

**43-20  
YARD REGULATIONS**

\* \* \*

**43-23  
Permitted Obstructions in Required Yards or Rear Yard Equivalents**

In all #Manufacturing Districts#, the obstructions set forth in Section 23-441 (General permitted obstructions), as well as the following obstructions, shall be permitted within a required #yard# or #rear yard equivalent#:

(a) In any #yard# or #rear yard equivalent#:

- (1) ~~Arbors or trellises;~~
- (2) ~~Awnings and other sun control devices, provided that when located at a level higher than the first #story#, excluding a #basement#, all such awnings and other sun control devices:~~
  - (i) ~~shall be limited to a maximum projection from a #building# wall of 2 feet, 6 inches; and~~
  - (ii) ~~shall have solid surfaces that, in aggregate, cover an area no more than 30 percent of the area of the #building# wall (as viewed in elevation) from which they project;~~
- (3) ~~Canopies;~~
- (4) ~~Chimneys, projecting not more than three feet into, and not exceeding two percent of the area of, the required #yard# or #rear yard equivalent#;~~
- (5) ~~Eaves, gutters or downspouts, projecting into such #yard# or #rear yard equivalent# not more than 16 inches or 20 percent of the width of such #yard# or #rear yard equivalent#, whichever is the lesser distance;~~
- (6) ~~Exterior wall thickness, where such wall thickness is added to the exterior face of a #building# wall existing on April 30, 2012, provided the added wall thickness has a thermal resistance (R value) of at least 1.5 per inch, and is limited to one inch of thickness for every foot of existing #yard# width, up to a maximum thickness of eight inches. When an open area is provided along a common #lot line#, then such exterior wall thickness is limited to one inch for every foot of existing open area on the #zoning lot#;~~

~~Where #buildings# that have added exterior wall thickness pursuant to this Section are #enlarged#, such #enlarged# portion may similarly encroach upon required #yards# in order to align with the exterior walls of the existing #building#, provided such #enlargement# contains less #floor area# than the existing #building#, and there is no encroachment of #floor area# into a required #yard#;~~
- (7)(1) ~~Fences;~~
- (8) ~~Flagpoles;~~
- (9)(2) ~~Parking spaces for automobiles or bicycles, off-street, open, #accessory#;~~
- (10)(3) ~~#Energy infrastructure equipment# and #accessory# mechanical equipment, provided that the height of all equipment shall not exceed a height of 23 feet above #curb level#;~~

~~Power systems, including, but not limited to, generators, solar energy systems, fuel cells, batteries and other energy storage systems, provided that all equipment shall not exceed a height of 23 feet above #curb level#;~~

- (11) ~~Solar energy systems on walls existing on April 30, 2012, projecting no more than 10 inches and occupying no more than 20 percent of the surface area of the #building# wall (as viewed in elevation) from which it projects;~~
- (12)(4) ~~Steps, and ramps or lifts for people with physical disabilities;~~
- (13) ~~Terraces or porches, open;~~
- (14)(5) ~~Walls, not exceeding eight feet in height and not roofed or part of a #building#.~~
- (b) In any #rear yard# or #rear yard equivalent#:
- (1) Any #building# or portion of a #building# used for any permitted #use#, except that any portion of a #building# containing rooms used for living or sleeping purposes (other than a room in a hospital used for the care and treatment of patients, or #joint living-work quarters for artists#) shall not be a permitted obstruction, and provided that the height of such #building# shall not exceed one #story#, excluding #basement#, nor in any event 23 feet above #curb level#. In addition, decks, parapet walls, roof thickness, skylights, vegetated roofs, and weirs, shall be permitted upon such #building#, or portion thereof, pursuant to Section 43-42 (Permitted Obstructions);
- (2) ~~Breezeways;~~
- (3) ~~Fire escapes;~~
- (4)(2) ~~Parking spaces for automobiles or bicycles, off-street, #accessory#, provided that the height of an #accessory# #building# used for such purposes and located in a required #rear yard# or #rear yard equivalent# shall not exceed 23 feet above #curb level#; or~~
- (3) Solar energy systems affixed to solar canopies and located over parking spaces associated with #public parking lots#, automobile rental establishments, or commercial or public utility vehicle parking facilities, as permitted, provided that the height shall not exceed 15 feet above the level of the adjoining grade.
- (5) ~~Solar energy systems on the roof of a #building# permitted as an obstruction to such #yard#:~~
- (i) ~~up to four feet in height as measured perpendicular to the roof surface when located above a permitted #commercial# or #community facility# #use# or attached parking structure; or~~
- (ii) ~~shall be limited to 18 inches in height as measured perpendicular to the roof surface when located above a shed or detached parking structure, or on any roof with a slope greater than 20 degrees;~~
- (6) ~~Water conserving devices, required in connection with air conditioning or refrigeration systems in #buildings# existing prior to May 20, 1966, if located not less than eight feet from any #lot line#.~~

However, no portion of a #rear yard equivalent# which is also a required #front yard# or required #side yard# may contain any obstructions not permitted in such #front yard# or #side yard#.

## 43-40 HEIGHT AND SETBACK REGULATIONS

\* \* \*

### 43-42 Permitted Obstructions

In all #Manufacturing Districts#, the obstructions set forth in Section 23-621 (General permitted obstructions), as well as the following obstructions, shall be permitted to penetrate a maximum height limit or a #sky exposure plane# set forth in Sections 43-43 (Maximum Height of Front Wall and Required Front Setbacks), 43-44 (Alternate Front Setbacks) or 43-49 (Limited Height Districts).

- (a) — Awnings and other sun control devices, provided that when located at a level higher than the first #story#, excluding a #basement#, all such awnings and other sun control devices:
- (1) — shall be limited to a maximum projection from a #building# wall of 2 feet, 6 inches, except when located on the first #story# above a setback;
  - (2) — shall have solid surfaces that, in aggregate, cover an area no more than 30 percent of the area of the #building# wall (as viewed in elevation) from which they project; and
  - (3) — may rise above the permitted #building# height, up to the height of a parapet wall or guardrail permitted in accordance with this Section.

When located on the first #story# above a setback, awnings and other sun control devices shall be limited to a projection of 50 percent of the depth of the required setback, and shall be limited, in total, to 50 percent of the width of the #building# wall from which they project;

- (b) — #Building# columns, having an aggregate width equal to not more than 20 percent of the #aggregate width of street walls# of a #building#, to a depth not exceeding 12 inches, in an #initial setback distance#, optional front open area, or any other required setback distance or open area set forth in Sections 43-43, 43-44 or 43-45 (Tower Regulations);
- (c) — Chimneys or flues, with a total width not exceeding 10 percent of the #aggregate width of street walls# of a #building# at any given level;
- (d) — Decks, and other surfaces for recreational activities, not more than 3 feet, 6 inches in height, as measured from the maximum height limit, or the finished level of the roof as it existed on April 30, 2012, whichever is higher;
- (e) — Elevator or stair bulkheads (including shafts; and vestibules not larger than 60 square feet in area providing access to a roof), roof water tanks and #accessory# mechanical equipment (including enclosures), other than solar or wind energy systems, provided that:
- (1) — such obstructions shall be located not less than 10 feet from the #street wall# of a #building#, except that such obstructions need not be set back more than 25 feet from a #narrow# #street line# or more than 20 feet from a #wide# #street line#. However, such restrictions on location shall not apply to elevator or stair bulkheads (including shafts or vestibules), provided the #aggregate width of street walls# of such bulkheads within 10 feet of a #street wall#, facing each #street# frontage, times their average height, in feet, does not exceed an area equal to four times the width, in feet, of the #street wall# of the #building# facing such frontage;

- ~~(2) all mechanical equipment shall be screened on all sides;~~
- ~~(3) such obstructions and screening are contained within a volume that complies with one of the following:~~
- ~~(i) the product, in square feet, of the #aggregate width of street walls# of such obstructions facing each #street# frontage, times their average height, shall not exceed an area equal to eight times the width, in feet, of the #street wall# of the #building# facing such frontage; or~~
  - ~~(ii) the #lot coverage# of all such obstructions does not exceed 20 percent of the #lot coverage# of the #building#, and where the maximum permitted height of a #building# is less than 120 feet, such obstructions are limited to a maximum height of 25 feet, and where the maximum permitted height of a #building# is 120 feet or greater, such obstructions are limited to a maximum height of 40 feet.~~

~~For the purposes of this paragraph, (e), #abutting# #buildings# on a single #zoning lot# may be considered to be a single #building#;~~

- (a) Elevator or stair bulkheads (including shafts; and vestibules not larger than 60 square feet in area providing access to a roof), roof water tanks, #energy infrastructure equipment#, and #accessory# mechanical equipment (including enclosures), other than solar or wind energy systems (whether #accessory# or as part of #energy infrastructure equipment#), provided that:
- (1) such obstructions shall be located not less than 10 feet from the #street wall# of a #building#, except that such obstructions need not be set back more than 25 feet from a #narrow# #street line# or more than 20 feet from a #wide# #street line#. However, such restrictions on location shall not apply to elevator or stair bulkheads (including shafts or vestibules), provided the #aggregate width of street walls# of such bulkheads within 10 feet of a #street wall#, facing each #street# frontage, does not exceed 30 percent of the #street wall# width of the #building# facing such frontage;
  - (2) the aggregate area of such obstructions, including any required screening, does not exceed 50 percent of the #lot coverage# of the #building#;
  - (3) the height of obstructions within an aggregate area equivalent to at least 20 percent of the #lot coverage# of the #building# shall not exceed 15 feet above the maximum permitted height; and
  - (4) the height of obstructions within the remaining #lot coverage#, not to exceed 30 percent of the #building# shall not exceed:
    - (i) where the maximum permitted height of a #building# is 120 feet or lower, a height of 35 feet above the maximum permitted height;
    - (ii) where the maximum permitted height of a #building# is greater than 120 feet, a height of 55 feet above the maximum permitted height; and
  - (5) all equipment shall be subject to the applicable provisions of Section 37-20 (SPECIAL SCREENING AND ENCLOSURE PROVISIONS);
- ~~(f) Exterior wall thickness, up to eight inches, where such wall thickness is added to the exterior face of a #building# wall existing on April 30, 2012, provided the added wall thickness has a thermal resistance~~

(R value) of at least 1.5 per inch. Where ~~#buildings#~~ that have added exterior wall thickness pursuant to this Section are ~~#enlarged#~~, such ~~#enlarged#~~ portion may similarly penetrate a maximum height limit in order to align with the exterior walls of the existing ~~#building#~~, provided such ~~#enlargement#~~ contains less ~~#floor area#~~ than the existing ~~#building#~~, and there is no penetration of ~~#floor area#~~ above a maximum height limit;

- (g) ~~Flagpoles or aerials;~~
- ~~(h)(b)~~ House of worship towers, ornamental, having no ~~#floor area#~~ in portion of tower penetrating such height limit or ~~#sky exposure plane#~~;
- (i) ~~Parapet walls, not more than four feet in height, as measured from the maximum height limit, or the finished level of the roof as it existed on April 30, 2012, whichever is higher. A guardrail with a surface at least 70 percent open or with an opacity of not more than 30 percent (as viewed in elevation), shall be permitted above a parapet wall or within two feet of a parapet wall, provided such guardrail is not more than four feet above the accessible level of a roof. Such restriction on guardrail height shall not apply when located beyond two feet from a parapet wall;~~
- (j) ~~Roof thickness, up to eight inches, to accommodate the addition of insulation, for #buildings# or portions of #buildings# constructed prior to April 30, 2012. For a #building# that has added roof thickness pursuant to this paragraph, (j), an #enlargement# may align with the finished roof surface of such #building#, provided the #enlarged# portion does not exceed the maximum height limit by more than eight inches;~~
- ~~(k)(c)~~ #Qualifying Rooftop greenhouses#, up to 25 feet in height, provided that such obstruction shall be located not less than six feet from the #street wall# of the #building#; ~~permitted pursuant to Section 75-01 (Certification for Rooftop Greenhouses);~~
- (l) ~~Skylights, clerestories or other daylighting devices, not more than four feet in height, as measured from the maximum height limit, or the finished level of the roof as it existed on April 30, 2012, whichever is higher. Such devices shall be limited to a #lot coverage# not greater than 10 percent of the #lot coverage# of the roof and be located at least eight feet from the #street wall# edge. However, such devices shall not be permitted obstructions above a roof with a slope greater than 20 degrees;~~
- (m) ~~Solar energy systems:~~
  - (1) ~~on the roof of a #building#, up to four feet in height, as measured from the maximum height limit, or the finished level of the roof, whichever is higher;~~
  - (2) ~~on the roof of a #building#, greater than four feet in height, as measured from the maximum height limit, or the finished level of the roof, whichever is higher, provided that all such portions above four feet are set back at least six feet from a #street wall#, limited to a #lot coverage# not greater than 25 percent of the #lot coverage# of the roof and do not exceed:~~
    - (i) ~~a height of 15 feet;~~
    - (ii) ~~a height of six feet when located on a bulkhead or other obstruction, pursuant to paragraph (e) of this Section;~~
  - (3) ~~on walls existing on April 30, 2012, projecting no more than 10 inches and occupying no more than 20 percent of the surface area of the #building# wall (as viewed in elevation) from which it projects.~~



~~However, any installation on a roof with a slope greater than 20 degrees shall be limited to 18 inches in height, as measured perpendicular to the roof surface;~~

~~(d)~~ Spires or belfries;

~~(e)~~ Vegetated roofs, not more than 3 feet, 6 inches in height, excluding vegetation, as measured from the maximum height limit, or the finished level of the roof as it existed on April 30, 2012, whichever is higher. On roofs with slopes greater than 20 degrees, vegetated roofs shall be limited to a height of 12 inches measured perpendicular to such roof surface;

~~(f)~~ Weirs, check dams and other equipment for stormwater management, not more than 3 feet, 6 inches in height, as measured from the maximum height limit, or the finished level of the roof as it existed on April 30, 2012, whichever is higher;

~~(g)~~ Wind energy systems, ~~accessory~~ or as part of ~~energy infrastructure equipment~~, on portions of ~~buildings~~ with a height of 100 feet or greater, provided:

- (1) the highest point of the wind turbine assembly does not exceed 55 feet;
- (2) no portion of the wind turbine assembly is closer than 10 feet to any ~~lot line~~; and
- (3) in districts where ~~residences~~ or ~~joint living-work quarters for artists~~ are permitted as-of-right, by special permit or by authorization, or within 100 feet of such districts, the diameter of the swept area of the rotor does not exceed 15 feet;

~~(h)~~ Window washing equipment mounted on a roof;

~~(i)~~ Wire, chain link or other transparent fences.

\* \* \*

**43-60  
SUPPLEMENTARY REGULATIONS**

\* \* \*

**43-62  
Bulk Regulations in M1-6D Districts**

\* \* \*

**43-624  
Height and setback in M1-6D Districts**

In M1-6D Districts, the height and setback provisions of this Section shall apply to all ~~buildings~~.

(a) Rooftop and permitted obstruction regulations

(1) Permitted obstructions

The provisions of Section 33-42 shall apply to all ~~buildings~~, ~~except that elevator or stair bulkheads, roof water tanks, cooling towers or other mechanical equipment (including enclosures) may penetrate a maximum height limit or sky exposure plane~~, provided that

either the product, in square feet, of the ~~#aggregate width of street walls#~~ of such obstructions facing each ~~#street#~~ frontage, times their average height, in feet, shall not exceed a figure equal to eight times the width, in feet, of the ~~#street wall#~~ of the ~~#building#~~ facing such frontage; or provided that the ~~#lot coverage#~~ of all such obstructions does not exceed 20 percent of the ~~#lot coverage#~~ of the ~~#building#~~, and the height of all such obstructions does not exceed 40 feet.

In addition, a maximum base height or ~~#sky exposure plane#~~ may be penetrated, as follows:

- (i) Structural columns

Structural columns may penetrate a maximum height limit or ~~#sky exposure plane#~~, provided that such columns are one story or less in height, have a ~~#street wall#~~ no greater than 30 inches in width, and are spaced not less than 15 feet on center.

- (ii) Dormers

On any ~~#street#~~ frontage, dormers may be provided in accordance with the provisions of paragraph (c) of Section ~~23-621~~ 23-623 (Permitted obstructions in certain districts).

- (2) Screening requirements for mechanical equipment

For all ~~#developments#~~ and ~~#enlargements#~~, and ~~#conversions#~~ of ~~#non-residential buildings#~~ to ~~#residences#~~, all mechanical equipment located on any roof of a ~~#building or other structure#~~ shall be subject to the provisions of Section 37-22 (Special Rooftop Screening and Enclosure Regulations) ~~fully screened on all sides. However, no such screening requirements shall apply to water tanks.~~

\* \* \*

**Chapter 4  
Accessory Off-Street Parking and Loading Regulations**

\* \* \*

**44-02  
Applicability**

Except as otherwise provided in this Section, the regulations of this Chapter on permitted or required ~~#accessory#~~ off-street parking spaces apply to ~~#manufacturing#~~, ~~#commercial#~~ or ~~#community facility#~~ ~~#uses#~~, as set forth in the provisions of the various Sections. In limited instances certain regulations also apply to ~~#public parking garages#~~ and ~~#public parking lots#~~.

\* \* \*

**44-026  
Applicability of regulations to public parking garages and public parking lots**

The following provisions of this Chapter shall apply to ~~#public parking garages#~~ and ~~#public parking lots#~~ in addition to ~~#accessory#~~ off-street parking facilities:

- Section 44-352      (Restrictions on the use of parking spaces in public parking garages and public parking lots)
- Section 44-423      (Calculating floor area in parking facilities with lift systems, or in automated parking facilities)
- Section 44-43        (Location of Access to the Street)
- Section 44-44        (Surfacing)
- Section 44-45        (Screening)
- Section 44-47        (Parking Lot Maneuverability and Curb Cut Regulations)

**44-03**

**Definitions**

\*       \*       \*

**44-20**

**REQUIRED ACCESSORY OFF-STREET PARKING SPACES FOR MANUFACTURING, COMMERCIAL OR COMMUNITY FACILITY USES**

\*       \*       \*

**44-21**

**General Provisions**

M1 M2 M3

In all districts, as indicated, #accessory# off-street parking spaces, open or enclosed, shall be provided in conformity with the requirements set forth in the table in this Section for all #development# after December 15, 1961, for the #manufacturing#, #commercial# or #community facility# #uses# listed in the table. In addition, all other applicable requirements of this Chapter shall apply as a condition precedent to the #use# of such #development#.

\*       \*       \*

**REQUIRED OFF-STREET PARKING SPACES FOR MANUFACTURING, COMMERCIAL OR COMMUNITY FACILITY USES**

Type of #Use#	Parking Spaces Required, in Relation to Specified Unit of Measurement	Districts
FOR MANUFACTURING OR COMMERCIAL USES		
#Manufacturing# or semi-industrial #uses#. #Uses# in Use Group 17B, 17D, or 18A or 18C, or in PRC-F in Use Group 11 or 16, and with a minimum of either 7,500 square feet of #floor area# or 15 employees.	None required	M1-4 M1-5 M1-6 M2-3 M2-4 M3-2
	1 per 1,000 square feet of #floor area# <sup>1</sup> , or 1 per 3 employees, whichever will require a larger number of spaces	M1-1 M1-2 M1-3 M2-1 M2-2 M3-1
	*       *       *	

NOTE: PRC = Parking Requirement Category

<sup>1</sup> For predominantly open #manufacturing# #uses#, the #lot area# used for such uses shall be considered as #floor area# for the purposes of these requirements

\* \* \*

**44-30  
RESTRICTIONS ON LOCATION AND USE OF ACCESSORY OFF-STREET PARKING SPACES**

\* \* \*

**44-35  
Restrictions on Use of Accessory Parking Spaces and Spaces in Public Parking Garages and Public Parking Lots**

**44-351  
Restrictions on Use of Accessory Off-street Parking Spaces use of accessory off-street parking spaces**

M1 M2 M3

In all districts, as indicated, #accessory# off-street parking spaces, whether permitted or required and whether open or enclosed, shall be used primarily for the owners, occupants, employees, customers, or visitors of the #use# or #uses# to which such spaces are #accessory#, except as set forth in this Section.

In all districts, up to five spaces or 20 percent of all #accessory# off-street parking spaces, whichever is greater, may be allocated to:

- (a) publicly available electric vehicle charging facilities;
- (b) #car sharing vehicles#;
- (c) vehicles stored by automobile rental establishments; or
- (d) commercial or public utility vehicle parking for motor vehicles not exceeding a length of 20 feet.

#Car sharing vehicles# may occupy #accessory# off street parking spaces in #group parking facilities# containing 20 spaces or more; however, the number of spaces so occupied shall not exceed 10 percent of all parking spaces in such #group parking facilities#.

**44-352  
Restrictions on use of parking spaces in public parking garages and public parking lots**

M1 M2 M3

In all districts, as indicated, off-street parking spaces in #public parking garages# and #public parking lots# may be made available for electric charging, or allocated to #car sharing vehicles#, vehicles stored by automobile rental establishments, or commercial or public utility vehicle parking, only as follows:

- (a) In all districts, all spaces within a #public parking garage# or #public parking lot# may be allocated to publicly available electric vehicle charging facilities.
- (b) In all districts, up to 50 percent of the parking spaces within a #public parking garage# or #public parking lot# may be allocated to:
  - (i) #car sharing vehicles#;
  - (ii) vehicles stored by automobile rental establishments; or
  - (iii) commercial or public utility vehicle parking for motor vehicles not exceeding a length of 20 feet.

**44-36  
Restrictions on Automotive Repairs and Sale of Motor Fuel**

M1 M2 M3

In all districts, as indicated, automotive repairs or the sale of motor fuel, motor oil, or automotive accessories are not permitted in connection with the operation of #accessory# off-street parking spaces. However where such parking spaces are provided in a #building or other structure#, minor automotive repairs (not including body work) are permitted, ~~and not more than three motor fuel pumps may be provided. However, no motor fuel shall be sold to persons who are not using the parking spaces.~~ The provisions of this Section are not applicable to #accessory# off-street parking spaces provided in #public parking garages#.

**44-37  
Electric Vehicle Charging**

Electric vehicle charging facilities shall be permitted at all #accessory# off-street parking spaces. Such charging shall be for the owners, occupants, employees, customers, residents or visitors using such #accessory# parking spaces, except as otherwise permitted by the provisions of Section 44-351 (Restrictions on use of accessory off-street parking spaces).

\* \* \*

**44-40  
ADDITIONAL REGULATIONS FOR PERMITTED OR REQUIRED OFF-STREET PARKING SPACES**

\* \* \*

**44-42  
Size and Identification of Spaces**

**44-421  
Size of spaces**

M1 M2 M3

(a) ~~Size of spaces~~ Minimum maneuvering space

In all districts, as indicated, for all #accessory# off-street parking spaces, open or enclosed, each 300 square feet of unobstructed standing or maneuvering area shall be considered one parking space, except as follows: -

(1) Standard attended facilities

~~However, an An~~ area of less than 300 square feet, but in no event less than 200 square feet, may be considered as one space, where the layout and design of the parking area are adequate to permit convenient access and maneuvering in accordance with regulations promulgated by the Commissioner of the Department of Buildings, or where the applicant for a building permit or certificate of occupancy certifies that such spaces will be fully attended.

In any case where a reduction of the required area per parking space is permitted on the basis of the applicant's certification that such spaces will be fully attended, it shall be set forth in the certificate of occupancy that paid attendants employed by the owners or operators of such spaces shall be available to handle the parking and moving of automobiles at all times when such spaces are in use.

(2) Attended facilities with parking lift systems

For portions of an attended parking facility with parking lift systems, each individually lifted tray upon which a vehicle is stored shall be considered one parking space. Any other attended space not on a lifted tray shall be subject to the provisions of paragraph (a)(1) of this Section.

(3) #Automated parking facilities#

For #automated parking facilities#, each tray upon which a vehicle is stored shall constitute one parking space. The term "tray" shall refer to the structural support for vehicle storage in both pallet and non-pallet vehicle storage systems.

However, auxiliary parking trays in an #automated parking facility# may be exempted from constituting a parking space where the Commissioner of Buildings determines that such auxiliary parking trays are necessary to store and retrieve vehicles for the efficient operation of such #automated parking facility#.

(b) Driveway access

Driveways used to access required parking spaces must be unobstructed for a width of at least eight feet and a height of eight feet above grade and if connecting to a #street#, such driveway may only be accessed by a curb cut.

~~In any case where a reduction of the required area per parking space is permitted on the basis of the applicant's certification that such spaces will be fully attended, it shall be set forth in the certificate of occupancy that paid attendants employed by the owners or operators of such spaces shall be available to handle the parking and moving of automobiles at all times when such spaces are in use.~~

(c) Minimum size for each parking space

In no event shall the dimensions of any parking stall be less than 18 feet long and 8 feet, 6 inches wide.

**44-422**  
**Identification of car sharing vehicles**

~~(b)~~ ~~Identification of #car sharing vehicles#~~

Within an off-street parking facility that contains #car sharing vehicles#, an information plaque shall be placed at a location accessible to and visible to users of such facility. The plaque shall be fully opaque, non-reflective and constructed of permanent, highly durable materials and shall contain the following statements in lettering no less than one inch high:

~~(1)(a)~~ “Total parking spaces in facility:” which shall specify the total number of parking spaces permitted within such parking facility; and

~~(2)(b)~~ “Maximum number of car sharing vehicles:” which shall specify the total number of #car sharing vehicles# permitted within such parking facility.

**44-423**  
**Calculating floor area in parking facilities with lift systems, or in automated parking facilities**

For enclosed #accessory# off-street parking facilities, or #public parking garages#, for the purposes of determining #floor area# in an #automated parking facility#, or an attended parking facility with parking lift systems, each tray upon which a vehicle is stored at a height that exceeds the permitted exemption set forth in the definition of #floor area# in Section 12-10, or as otherwise modified in this Resolution, as applicable, shall be considered #floor area# in an amount of 153 square feet, or the size of such lifted tray, whichever is greater.

\* \* \*

**44-44**  
**Surfacing**

M1 M2 M3

In all districts, as indicated, all open #accessory# off-street parking spaces or permitted #public parking lots# shall be graded, constructed, surfaced, and maintained so as to provide adequate drainage and to prevent the release of dust, in accordance with rules and regulations promulgated by the Commissioner of Buildings.

Any area intended to be used permanently for an open #accessory# #group parking facility# shall be surfaced with permeable paving materials, asphaltic or Portland cement concrete, or other hard-surfaced dustless material, at least four inches thick. However, permeable paving materials may be used in open parking areas where the Commissioner of Buildings determines that such materials are appropriate.

\* \* \*

**44-60**  
**BICYCLE PARKING**

\* \* \*

However, in no event shall #accessory# bicycle parking spaces be excluded from the calculation of #floor area# in the case of #single-# or #two-family residences# or in the case of #accessory# bicycle parking spaces provided off-site pursuant to Section 36-74 (~~Certification for~~ Off-site Bicycle Parking Spaces).

\* \* \*

**ARTICLE V  
NON-CONFORMING USES AND NON-COMPLYING BUILDINGS**

**Chapter 2  
Non-Conforming Uses**

\* \* \*

**52-20  
REPAIRS OR ALTERATIONS**

\* \* \*

**52-22  
Structural Alterations**

No structural alterations shall be made in a #building or other structure# substantially occupied by a #non-conforming# #use#, except when made:

- (a) in order to comply with requirements of law; or
- (b) in order to accommodate a conforming #use#; or
- (c) in order to conform to the applicable district regulations on performance standards; or
- (d) in the course of an #enlargement# permitted under the provisions of Sections 52-41 to 52-46, inclusive, relating to ~~E~~enlargements or ~~E~~extensions; or
- (e) in the course of an alteration to improve the energy performance of the #building or other structure#, including, but not limited to, the addition of solar energy systems, energy storage systems, or #qualifying exterior wall thickness#;
- (f) or except as set forth in Sections 52-81 to 52-83, inclusive, relating to ~~R~~regulations ~~A~~applying to ~~N~~non-~~C~~onforming ~~S~~signs.

\* \* \*

**52-40  
ENLARGEMENTS OR EXTENSIONS**

\* \* \*

**52-41  
General Provisions**



A #non-conforming# #use# may be #enlarged# or #extended# within the district in which such #non-conforming# #use# is located only in accordance with the provisions of this Chapter. However, a #non-conforming# #single-# or #two-family residence# in an R3, R4 or R5 District may be #enlarged# or #extended# in accordance with the #bulk# regulations specified for the district in which it is located. Furthermore, #enlargements# or #extensions# designed exclusively to permit conformity with the regulations on performance standards, designed in order to improve energy performance, or designed in order to provide required #accessory# off-street parking spaces or off-street loading berths on the same #zoning lot# as the #use# to which such spaces or berths are #accessory# are not subject to the restrictions set forth herein.

\* \* \*

**52-60  
DISCONTINUANCE**

**52-61  
General Provisions**

\* \* \*

Except in Historic Districts as designated by the Landmarks Preservation Commission, the provisions of this Section shall not apply to vacant ground floor or #basement# stores in #buildings designed for residential use# located in R5, R6 or R7 Districts where the changed or reactivated #use# is listed in Use Group 6A, 6B, or 6C ~~or 6F~~ excluding post offices, veterinary medicine for small animals, automobile supply stores, electrolysis studios and drive-in banks. In addition, the changed or reactivated #use# shall be subject to the provisions of Section 52-34 (Commercial Uses in Residence Districts).

\* \* \*

**Chapter 4  
Non-Complying Buildings**

\* \* \*

**54-30  
ENLARGEMENTS OR CONVERSIONS**

**54-31  
General Provisions**

Except as otherwise provided in ~~Section 54-313~~ this Chapter, a #non-complying# #building or other structure# may be #enlarged# or #converted#, provided that no #enlargement# or #conversion# may be made which would either create a new #non-compliance# or increase the degree of #non-compliance# of a #building or other structure# or any portion thereof.

\* \* \*

**54-313  
Single- or two-family residences with non-complying front yards or side yards**

\* \* \*

- (b) In all districts, for an existing #single-# or #two-family residence# with a #non-complying# #side yard#, an #enlargement# involving a vertical extension of existing #building# walls facing such #non-complying# #side yard# is permitted, provided the following conditions are met:

\* \* \*

Notwithstanding the provisions set forth in paragraphs (a)(1) and (b)(1) of this Section, when an existing #building# has added ~~exterior wall thickness~~ #qualifying exterior wall thickness# pursuant to Section 23-44 (Permitted Obstructions in Required Yards or Rear Yard Equivalents), such vertical extensions may align with the location of the finished exterior #building# wall of the existing #building#.

\* \* \*

#### **54-42**

##### **Use of Alternative Formula**

In any case where the applicant alleges that #floor area# is an inappropriate measure of the extent of damage or destruction, and elects to substitute reconstruction costs for #floor area#, an application may be made to the Board of Standards and Appeals to determine the extent of the damage or destruction. Such a #building# may be reconstructed as provided in Section 54-41 (Permitted Reconstruction), substituting the ratio which the cost of reconstructing the damaged or destroyed portion of such #building# bears to the cost of reconstructing the entire #building#, for the percentage of total #floor area#. In determining reconstruction costs, the cost of land shall be excluded.

#### **54-50**

##### **MODIFICATIONS TO THE PROVISIONS OF THIS CHAPTER**

#### **54-51**

##### **Energy Infrastructure or Retrofits**

Notwithstanding the other provisions of this Chapter, in all districts, a #development#, #enlargement# or alteration comprised exclusively of the addition of #energy infrastructure equipment#, #accessory# mechanical equipment, or #qualifying exterior wall thickness#, whether to a #building# or to an open area of the #zoning lot#, may create a new #non-compliance# or increase the degree of #non-compliance# of a #building# or other structure#, provided that:

- (a) where locating such equipment in a #non-complying# #open space#, #yard#, #rear yard equivalent#, or #court#, as applicable, such equipment shall comply with the applicable height and area restrictions for the respective open area set forth in the applicable underlying district regulations, as applied to the level and size of the #non-complying# open area;
- (b) where locating such equipment onto the rooftop of a #building# that is #non-complying# with respect to height and setback regulations, such equipment shall comply with the height and area regulations for such permitted obstruction set forth in the applicable underlying district regulations, as applied to the level of the rooftop, inclusive of any #non-compliance# into a required setback area, #yard#, or other required open area;

- (c) at any level, all #energy infrastructure equipment# or #accessory# mechanical equipment will be enclosed or screened in compliance with the applicable provisions for such permitted obstructions; and
- (d) where locating #qualifying exterior wall thickness# into either a #non-complying# #open space#, #yard#, #rear yard#, or # court#, or into a #non-complying# distance between two #buildings# or a #non-complying# distance between a #building# and #lot line#, or in a location not otherwise permitted by underlying #street wall location rules#, such additional encroachment of wall thickness shall not exceed the depth permitted by the underlying permitted obstruction regulations.

\* \* \*

**ARTICLE VI  
SPECIAL REGULATIONS APPLICABLE TO CERTAIN AREAS**

**Chapter 2  
Special Regulations Applying in the Waterfront Area**

\* \* \*

**62-10  
GENERAL PROVISIONS**

**62-11  
Definitions**

Definitions specially applicable to this Chapter are set forth in this Section. The definitions of other defined terms are set forth in Section 12-10 (DEFINITIONS) and Section 64-11 (Definitions).

**Development**

For the purposes of this Chapter, a “development” shall also include:

- (a) an #enlargement#;
- (b) any alteration that increases the height or coverage of an existing #building or other structure#;
- (c) an #extension#; or
- (d) a change of #use# from one Use Group to another, or from one #use# to another in the same Use Group, or from one #use# listed in Section 62-21 (Classification of Uses in the Waterfront Area) to another such #use#.

However, a #development# shall not include incidental modifications to a #zoning lot#, including but not limited to, the addition of deployable flood control measures and any associated permanent fixtures, the addition of temporary structures such as trash receptacles, food carts or kiosks, and the incorporation of minor permanent structures such as light stanchions, bollards, fences, or structural landscaped berms and any associated flood gates. All such modifications shall remain subject to any associated permitted obstruction allowances, as applicable.

Furthermore, a #development# shall not include the exclusive addition of #energy infrastructure equipment#, #accessory# mechanical equipment, electric vehicle charging facilities, as a primary or #accessory# #use#, or #qualifying exterior wall thickness#, whether added to a #building# or to an open area of the #zoning lot#.

\* \* \*

**62-30  
SPECIAL BULK REGULATIONS**

\* \* \*

**62-34  
Height and Setback Regulations on Waterfront Blocks**

\* \* \*

**62-341  
Developments on land and platforms**

\* \* \*

- (a) For the purposes of applying the height and setback regulations of this Section, the following provisions shall apply:

\* \* \*

- (4) Permitted obstructions

The obstructions permitted pursuant to Sections 23-62, inclusive, 24-51, 33-42 or 43-42 and, where applicable, Sections 64-331, 64-332 or 64-432, shall apply. In addition, the following regulations regarding permitted obstructions shall apply:

- (i) Within an #initial setback distance#, a dormer may exceed a maximum base height specified in Table A of this Section or penetrate a required setback area above a maximum base height specified in paragraph (d) of this Section, provided that such dormer complies with the provisions of paragraph (c)(1) of Section ~~23-62~~ 23-623.

\* \* \*

**62-80  
SPECIAL REVIEW PROVISIONS**

\* \* \*

**62-82  
Authorizations by the City Planning Commission**

\* \* \*

**62-825  
Modifications for wind energy systems**

In any district, the City Planning Commission may authorize modifications to the applicable #bulk# or #waterfront public access area# regulations in order to accommodate wind energy systems, whether #accessory# or as part of #energy infrastructure equipment#, provided the Commission finds that:

- (a) there would be a practical difficulty in complying with regulations set forth for wind energy systems as set forth in the underlying district regulations, and as modified by this Chapter, without such modifications;
- (b) such modifications are the minimum necessary to allow for an appropriate wind energy system; and
- (c) the proposed modifications will not alter the essential character of the neighborhood in which the #building# is located.

The Commission may prescribe appropriate conditions and safeguards to minimize adverse effects on the character of the surrounding area.

**62-83  
Special Permits by the City Planning Commission**

\* \* \*

**Chapter 3  
Special Regulations Applying to FRESH Food Stores**

\* \* \*

**63-11  
Special Use Regulations for FRESH Food Stores in M1 Districts**

In M1 Districts, the regulations of Section 42-12 (Use Groups 3A, 6A, 6B, 6D, 6F, 7B, 7C, 7D, ~~7E~~, 8, 9B, ~~9C~~, 10A, 10B, ~~10C~~, 11, 12A, 12C, 12D, ~~12E~~, 13, 14 and 16) are modified to permit #FRESH food stores# with up to 30,000 square feet of #floor area#. The provisions of this Section shall not apply where the regulations of the underlying district permit Use Group 6A food stores with #floor area# greater than 30,000 square feet.

\* \* \*

**Chapter 4  
Special Regulations Applying in Flood Zones**

\* \* \*

**64-30  
SPECIAL BULK REGULATIONS**

\* \* \*

**64-311  
Special floor area modifications for all buildings**

For all #buildings#, the definition of #floor area# in Section 12-10 (DEFINITIONS) shall be modified in accordance with the provisions of this Section.

(a) Mechanical equipment

~~In R1-2A, R2A, R2X, R3, R4 or R5 Districts, the limitations on exempting #floor area# for mechanical equipment set forth in paragraphs (m) and (8) in the definition of #floor area# in Section 12-10 (DEFINITIONS), shall not apply, provided that all mechanical equipment is located at or above the #flood-resistant construction elevation#.~~

~~(b)~~ (a) Flood control devices

In all districts, for every linear foot of protection by temporary flood control devices and associated fixtures, including emergency egress systems that are assembled prior to a storm and removed thereafter, up to 15 square feet of floor space used for the storage of such devices may be excluded from the definition of #floor area#, provided that in no event shall such exempted floor space exceed 1,000 square feet.

~~(c)~~ (b) Buildings containing non-#residential uses#

\* \* \*

**64-312**

**Permitted obstructions in required yards, courts, and open spaces for all zoning lots**

The regulations for permitted obstructions in #yards#, #courts# and #open space# shall be modified in accordance with the provisions of this Section.

(a) Mechanical equipment

[THE ALLOWANCE FOR MECHANICAL EQUIPMENT TO BE LOCATED IN THE SAME PLACES AS POWER SYSTEMS, AS WELL, AS THE ACCOMPANYING ENCLOSURE AND SCREENING REQUIREMENTS, ARE BEING RELOCATED TO THE RELEVANT SECTIONS OF THE UNDERLYING DISTRICT REGULATIONS.]

~~In all districts, the underlying allowances for #accessory# power systems as permitted obstructions in any #open space#, #yard#, #rear yard equivalent#, or #court#, may be expanded to include all and #accessory# mechanical equipment, provided that shall be modified so that~~

- ~~(1) all equipment shall be subject to the following enclosure and screening requirements, as applicable:
 
  - ~~(i) all power system equipment shall be enclosed within a #building or other structure#, or screened, as applicable, pursuant to the requirements set forth in the applicable underlying district allowances;~~
  - ~~(ii) all other types of equipment, including all mechanical, electrical and plumbing equipment, shall be completely enclosed within a #building or other structure#, except as necessary for mechanical ventilation; and~~~~
- ~~(2) the size and location of all #accessory# mechanical equipment, including all screening and enclosures containing such equipment, shall not exceed the size limitations specified in the underlying allowances, except that, where such~~

In all districts, where such #energy infrastructure equipment# or #accessory# mechanical equipment is elevated above the #flood-resistant construction elevation#, the underlying permitted obstruction regulations for such equipment ~~permitted size and location of such #accessory# mechanical equipment~~ may be modified as follows:

- (i)(1) where any equipment is required to be located at least five feet from any #lot line#, such distance may be reduced to three feet for #zoning lots# that have less than the prescribed minimum #lot area# or #lot width# required by the applicable district regulations;
- (ii)(2) the maximum height of such permitted obstructions for the applicable district:
  - (a)(i) may be measured from the #reference plane# instead of the level of the adjoining grade or #curb level#, as applicable; or
  - (b)(ii) for #zoning lots# containing #residences# and a #lot area# greater than or equal to one and one-half acres, may exceed the applicable height limitations, provided that:
    - (1)(a) such equipment is contained within a #building or other structure# that is located at least 30 feet from any #legally required window#;
    - (2)(b) any stack associated with heating, ventilation, and air conditioning (HVAC) systems exhausts at a height at least as tall as the tallest #building# containing #residences# on the #zoning lot#; and
    - (3)(c) such #building or other structure# complies with one point of the streetscape mitigations set forth in Section 64-52 (Ground floor level mitigation options); and
- (iii)(3) the maximum area that such equipment may occupy within a required #side yard#, #rear yard# or #rear yard equivalent#, or any #court# containing #legally required windows# need not apply where the height of such obstructions do not exceed the applicable underlying height allowances, as modified by the provisions of paragraph (a)(2)(i)(ii)(a) of this Section.

(b) Berms

In all districts, structural landscaped berms and associated flood gates, including emergency egress systems that are assembled prior to a storm and removed thereafter, shall be permitted obstructions in any required #open space#, #yard# or #rear yard equivalent# on the #zoning lot#, provided that the height of such berm does not exceed the highest #flood-resistant construction elevation# required on the #zoning lot#, or five feet above the lowest adjoining grade, whichever is higher.

(c) Flood control devices

In all districts, temporary flood control devices and associated permanent fixtures, including emergency egress systems that are assembled prior to a storm and removed thereafter shall be permitted obstructions in #yards# and #rear yard equivalents#, #courts#, #open space#, #public plazas#, #arcades#, pedestrian circulation spaces and all other publicly accessible open spaces. However, permanent fixtures for self-standing flood control devices installed in #publicly accessible open areas#, #arcades#, and pedestrian circulation spaces shall be flush-to-grade.

## (d) Steps

In all #Residence Districts#, the provisions of paragraph (a)(17) of Section 23-44 (Permitted Obstructions in Required Yards or Rear Yard Equivalents) (8) of Section 23-442 (Additional permitted obstructions) shall be modified to allow steps within a required #yard# or #rear yard equivalent#, provided that such steps access any #story# located at or below the #first story above the flood elevation#.

**64-313****Special height and setback regulations for all buildings**

The regulations for permitted obstructions to applicable height and setback regulations shall be modified in accordance with the provisions of this Section.

## (a) Bulkheads and mechanical equipment in low density #Residence Districts#

In R3-2, R4, and R5 Districts, except R4-1, R4A, R4B and R5A Districts, for #buildings# other than #single # and #two-family residences#, the underlying permitted obstructions regulations governing elevator or stair bulkheads (including shafts, and vestibules not larger than 60 square feet in area providing access to a roof), roof water tanks, and #accessory# mechanical equipment, other than solar or wind energy systems, may be modified as follows:

- (1) In R3-2 and R4 Districts, for #buildings#, or portions thereof, subject to the provisions of Article II, Chapter 3, the provisions of Section 23-621 (Permitted obstructions in certain districts) shall be modified to permit such obstructions, provided that:
  - (i) such obstructions shall be located not less than 10 feet from the #street wall# of a #building#;
  - (ii) all mechanical equipment shall be screened on all sides;
  - (iii) the #lot coverage# of all such obstructions and such screening shall not exceed 250 square feet or 10 percent of the #lot coverage# of the #building#, whichever is greater; and
  - (iv) such obstructions are limited to a height of 15 feet above the maximum height of perimeter walls;
- (2) In R3-2 and R4 Districts, for #buildings#, or portions thereof, subject to the provisions of Article II, Chapter 4, the provisions of paragraph (f) of Section 24-51 (Permitted Obstructions) shall apply, except that the maximum #lot coverage# may be increased from 20 percent to 30 percent of the #lot coverage# of the #building#, provided that such obstructions are limited to a maximum height of 25 feet;
- (3) In R5 Districts, the provisions of paragraph (g) of Section 23-62 (Permitted Obstructions), and paragraph (f) of Section 24-51 shall apply, as applicable, except that the maximum #lot coverage# may be increased from 20 percent to 30 percent of the #lot coverage# of the #building#, provided that such obstructions are limited to a maximum height of 25 feet.



~~(b) Bulkheads and mechanical equipment in medium and high density #Residence Districts#, and #Commercial# and #Manufacturing Districts#~~

~~In R6 through R10 Districts, and in all #Commercial# and #Manufacturing Districts#, the underlying permitted obstructions regulations of paragraph (g) of Section 23-62, paragraph (f) of Section 24-51, paragraph (f) of Section 33-42, or paragraph (e) of Section 43-42, as applicable, governing elevator or stair bulkheads (including shafts, and vestibules not larger than 60 square feet in area providing access to a roof), roof water tanks, and #accessory# mechanical equipment, other than solar or wind energy systems, may be modified as follows:~~

~~(1) where the maximum permitted height of a #building#, or portion thereof is less than 120 feet:~~

- ~~(i) the maximum #lot coverage# may be increased from 20 percent to 30 percent of the #lot coverage# of the #building#, provided that such obstructions are limited to a maximum height of 25 feet; or~~
- ~~(ii) the maximum permitted height of such volume may be increased from 25 feet to 33 feet, provided that the #lot coverage# of all such obstructions does not exceed 20 percent of the #lot coverage# of the #building#;~~

~~(2) where the maximum permitted height of a #building#, or portion thereof is 120 feet or greater:~~

- ~~(i) the maximum #lot coverage# may be increased from 20 percent to a maximum #lot coverage# of 30 percent of the #lot coverage# of the #building#, provided that such obstructions are limited to a maximum height of 40 feet; or~~
- ~~(ii) the maximum permitted height of such volume may be increased from 40 feet to 55 feet, provided that the #lot coverage# of all such obstructions does not exceed 20 percent of the #lot coverage# of the #building#.~~

~~(c)~~

~~For #Quality Housing buildings#, or portions thereof, as an alternative to the provisions of paragraph (c) of Section 23-621 23-623, dormers may be a permitted obstruction within a required front setback distance above a maximum base height, provided that the aggregate width of all dormers at the maximum base height does not exceed 40 percent of the width of the #street wall# of the highest #story# entirely below the maximum base height. Such dormers need not decrease in width as the height above the maximum base height increases.~~

**64-32  
Special Bulk Regulations for Flood-resistant Buildings**

\* \* \*

**Chapter 6  
Special Regulations Applying Around Mass Transit Stations**

\* \* \*

**66-20  
SPECIAL PROVISIONS FOR PRIMARY TRANSIT-ADJACENT SIREES**

\* \* \*

**66-23  
Special Bulk Regulations**

\* \* \*

**66-234  
Special height and setback modifications**

The height and setback modifications of this Section shall apply as follows:

(a) Permitted obstructions

(1) #Easement volumes#

Any portion of an #easement volume# shall be considered a permitted obstruction within a required setback or above any maximum base height, maximum #building# height, or #sky exposure plane# set forth in height and setback regulations of this Resolution. Any #easement volume#, including any #use# or structure therein, shall be located at least 30 feet from any #legally required window# at the same level on the #zoning lot#.

(2) Dormers

For #Quality Housing buildings#, as an alternative to the provisions of paragraph (c) of Section ~~23-624~~ 23-623, dormers may be a permitted obstruction within a required front setback distance above a maximum base height, provided that the aggregate width of all dormers at the maximum base height does not exceed 40 percent of the width of the #street wall# of the highest #story# entirely below the maximum base height. Such dormers need not decrease in width as the height above the maximum base height increases. For the purposes of this paragraph, the width of the #street wall# shall be determined pursuant to the provisions of paragraph (a) of Section ~~234~~ 66-233 (Special street wall modifications).

\* \* \*

**ARTICLE VII  
ADMINISTRATION**

\* \* \*

**Chapter 3  
Special Permits by the Board of Standard of Appeals**

\* \* \*

**73-14  
Public Service Establishments**

In all #Residence Districts#, the Board of Standards and Appeals may permit the #uses# set forth in paragraph (a) of this Section, provided that the findings set forth in paragraph (b) are met.

(a) The Board may permit the following #uses#:

~~e~~Electric or gas utility substations, limited in each case to a site of not more than 10,000 square feet;  
~~p~~Potable water pumping stations; ~~or~~;  
~~t~~Telephone exchanges or other communications equipment structures; ~~or~~  
#Energy infrastructure equipment#, without size restriction.

~~provided that the following findings are made:~~

(b) In order to grant such permit, the Board shall find:

- ~~(a)~~(1) that such #use# will serve the residential area within which it is proposed to be located;
- (2) that there are serious difficulties in locating it in a district wherein it is permitted as of right and from which it could serve the residential area, which make it necessary to locate such #use# within a #Residence District#; and
- ~~(b)~~(3) in the case of such electric or gas utility substations or potable water pumping stations, that the site for such #use# has a minimum #lot area# of 4,500 square feet.

The Board may prescribe appropriate conditions or safeguards to minimize adverse effects on the character of the surrounding area, ~~including requirements that electric utility substations shall meet the performance standards for an M1 District; that such electric or gas utility substations or potable water pumping stations shall be surrounded with fences, barriers, or other safety devices; or that any such #use# shall be landscaped.~~

\* \* \*

**73-65**  
**Public Utilities and Special Infrastructure**

**73-651**  
**Enlargement of Ppublic Uutility Ffacilities**

The Board of Standards and Appeals may permit modifications to the #bulk# regulations for certain #enlargements# of public utility facilities set forth in paragraph (a) of this Section, provided that the findings set forth in paragraph (b) are met.

(a) The Board may permit an #enlargements# which does do not comply with the applicable district #bulk# regulations for any #buildings or other structures# existing on December 15, 1961, within which any one of the following public utilities is located:

- Electric or gas utility substations;
- Telephone exchanges or other communications equipment structures;
- Water or sewage pumping stations; or
- #Energy infrastructure equipment#.

(b) In order to grant such permit, the Board shall find:

~~provided that the following findings are made:~~

- ~~(a)(1)~~ that the growth of the utility service demand in the area served by the #building or other structure# requires such #enlargement# to house the additional facilities needed to fulfill the demand;
- ~~(b)(2)~~ that the network of lines, pipes or other distribution facilities located below the surface of the #streets# is so integrated with the operations carried on within such #building# that the provision of such additional facilities at another location would cause substantial duplication of plant and facilities and inconvenience to the public; and
- ~~(c)(3)~~ that #non-compliance#, if any, with the applicable #yard# or height and setback regulations is the minimum made necessary by essential engineering requirements.

The Board may prescribe appropriate conditions and safeguards to minimize adverse effects on the character of the surrounding area and shall require that the certificate of occupancy shall be limited to such #use#.

### **73-652**

#### **Energy infrastructure equipment and mechanical equipment**

The Board of Standards and Appeals may permit the #bulk# modifications set forth in paragraph (a) of this Section, provided that the findings set forth in paragraph (b) are met.

- (a) The Board may permit modifications to all #bulk# regulations, other than #floor area ratio#, in order to accommodate #energy infrastructure equipment# or #accessory# mechanical equipment.
- (b) In order to grant such permit, the Board shall find that:
  - (1) such modifications would facilitate one or more of the following sustainability goals:
    - (i) reduction of the electrical demand of the #building# on the energy grid;
    - (ii) increased energy generation or storage at an essential location for the purposes of operating the energy grid;
    - (iii) support compliance with the standards of the New York City Energy Conservation Code (NYCECC); or
    - (iv) support compliance with the carbon emission reduction requirements of Local Law 97 of 2019;
  - (2) such modifications are the minimum necessary to allow for an appropriate installation, with consideration for collocation of other #uses#, whether upon a rooftop, within a #building or other structure#, or in an open area on the #zoning lot#; and
  - (3) the proposed modifications will not impair the character or the future use or development of the surrounding area.

The Board may prescribe appropriate conditions and safeguards to minimize adverse effects on the character of the surrounding area.

**73-66**  
**Height Regulations Around Airports**

\* \* \*

**Chapter 5**  
**Certifications**

**75-00**  
**CERTIFICATIONS**

**75-01**  
**Certification for Rooftop Greenhouses**

A rooftop greenhouse shall be excluded from the definition of #floor area# and may exceed #building# height limits, upon certification by the Chairperson of the City Planning Commission that such rooftop greenhouse:

- (a) is located on the roof of a #building# that does not contain #residences# or other #uses# with sleeping accommodations;
- (b) will only be used for cultivation of plants, or primarily for cultivation of plants when #accessory# to a #community facility use#;
- (c) is no more than 25 feet in height;
- (d) has roofs and walls consisting of at least 70 percent transparent materials, except as permitted pursuant to paragraph (f)(3) of this Section;
- (e) where exceeding #building# height limits, is set back from the perimeter wall of the #story# immediately below by at least six feet on all sides; and
- (f) has been represented in plans showing:
  - (1) the area and dimensions of the proposed greenhouse, the location of the existing or proposed #building# upon which the greenhouse will be located, and access to and from the #building# to the greenhouse;
  - (2) that the design of the greenhouse incorporates a rainwater collection and reuse system; and
  - (3) any portions of the greenhouse dedicated to office or storage space #accessory# to the greenhouse, which shall be limited to 20 percent of the floor space of the greenhouse, and shall be exempt from the transparency requirement in paragraph (d) of this Section.

Plans submitted shall include sections and elevations, as necessary to demonstrate compliance with the provisions of paragraphs (a) through (f) of this Section, as applicable. A copy of the proposed rooftop greenhouse plan shall be delivered to the affected Community Board, which may review such proposal and submit comments to the Chairperson of the Commission. The certification of a rooftop greenhouse shall not be complete until the earlier of the date that the affected Community Board submits comments regarding such proposal to the Chairperson of the Commission or informs the Chairperson that such Community Board has no comments; or 45 days from the date that such proposal was submitted to the affected Community Board.

~~No building permits or certificates of occupancy related to the addition of #residences# or other #uses# with sleeping accommodations within the #building# may be issued by the Department of Buildings unless and until such rooftop greenhouse has been fully dismantled. A Notice of Restrictions shall be recorded for the #zoning lot# providing notice of the certification pursuant to this Section. The form and contents of the legal instrument shall be satisfactory to the Chairperson of the City Planning Commission, and the filing and recording of such instrument shall be a precondition to the use of such rooftop greenhouse. The recording information for the rooftop greenhouse certification shall be referenced on the first certificate of occupancy to be issued after such notice is recorded, as well as all subsequent certificates of occupancy, for as long as the rooftop greenhouse remains intact.~~

\* \* \*

**Chapter 8  
Special Regulations Applying to Large-Scale Residential Developments**

\* \* \*

**78-00  
GENERAL PURPOSES, DEFINITIONS AND GENERAL PROVISIONS**

\* \* \*

**78-06  
Ownership**

\* \* \*

(b) Notwithstanding the provisions of paragraph (a) of this Section, the following actions shall be permitted:

\* \* \*

(3) The owner(s) of a developed parcel(s) within a #large-scale residential development# located in a former urban renewal area listed in paragraph (b)(2), where at least 50 percent of such parcel(s) is located within a C1-9 or C2-8 District, may make application for, and may be granted, modifications of authorizations or special permits previously granted under the provisions of this Chapter, in order to utilize available #floor area# for #commercial# or #community facility# #uses#, subject to the conditions of paragraph (b)(5) of this Section and provided further that:

- (i) no #residential use# existing prior to July 23, 2008, located above the level of the ground floor may be changed to a non-#residential use#;
- (ii) the #enlarged# portion of the #building# shall be restricted to #community facility# #uses# and #commercial# #uses# listed in Use Groups 6A, ~~and 6C and 6F~~, provided that any ground floor #community facility# #use#, and any bank or loan office shall occupy not more than 25 feet of the #wide street# frontage, measured to a depth of 30 feet from the #wide# #street line#, and no #community facility# #use# shall be permitted above the level of the second #story# ceiling;

\* \* \*

**78-22  
Accessory Uses in Large-Scale Residential Developments**

A #large-scale residential development# in a #Residence District# may contain as #accessory# #uses#, any #commercial# #uses# listed in Use Group 6A ~~or 6F~~ which in the aggregate occupy not more than two percent of the total #floor area# in the #large-scale residential development#, and of which no single establishment occupies more than 15,000 square feet of #floor area#, provided that upon a review of the site plan, the City Planning Commission finds that such #commercial# #uses#:

\* \* \*

**78-35  
Special Bonus Provisions**

\* \* \*

**78-353  
Bonus for enclosed parking**

In R4 or R5 Districts, or in #Commercial Districts# in which #residential buildings# are governed by the #bulk# regulations of such #Residence Districts#, for any #large-scale residential development# which complies with the provisions of Section 78-34 (Special Permit Provisions for Certain Large-scale Developments), the permitted #residential# #floor area ratio# may be increased over the amount earned by other provisions of Section 78-35 (Special Bonus Provisions) and the required #open space ratio# for the #large-scale residential development# as a whole correspondingly decreased as set forth in this Section provided that at least two-thirds of the required off-street parking is enclosed.

District	Increase in #Floor Area Ratio#	Decrease in #Open Space Ratio#
R4	.25	14.5
R5	.25	10.0

For any #large-scale residential developments# comprising #buildings# of not more than four #stories# receiving a bonus under this Section, the Commission may modify where appropriate the requirements of Section 23-12 (Permitted Obstructions in Open Space), paragraph ~~(e)~~ (c).

\* \* \*

**ARTICLE VIII  
SPECIAL PURPOSE DISTRICTS**

\* \* \*

**Chapter 1  
Special Midtown District**

\* \* \*

**81-25  
General Provisions Relating to Height and Setback of Buildings**

\* \* \*

**81-252  
Permitted obstructions**

Except as set forth in this Section, structures which under the provisions of Sections 33-42 or 43-42 (Permitted obstructions) or 34-11 or 35-10 (GENERAL PROVISIONS), are permitted to penetrate a maximum height limit or a #sky exposure plane# shall not be permitted as exceptions to the height limitations, setback requirements or rules for the measurement of #encroachments# or #compensating recesses# set forth in Section 81-26 (Height and Setback Regulations—Daylight Compensation), nor shall they be excluded in determining daylight blockage pursuant to the provisions of Section 81-27 (Alternate Height and Setback Regulations—Daylight Evaluation).

The following shall be permitted as exceptions to the height regulations, setback requirements or rules for the measurement of #encroachments# or #compensating recesses#, set forth in Section 81-26, and shall be excluded in determining daylight blockage, pursuant to the provisions of Section 81-27:

- (a) unenclosed balconies conforming to the provisions of Section 23-13 (Balconies); and
- (b) ~~#qualifying exterior wall thickness#, exterior wall thickness, up to eight inches, where such wall thickness is added to the exterior face of a #building# wall existing on April 30, 2012, provided the added wall thickness has a thermal resistance (R value) of at least 1.5 per inch. Where~~ where #buildings# that have added exterior wall thickness pursuant to this Section are #enlarged#, such #enlarged# portion may similarly penetrate a maximum height limit in order to align with the exterior walls of the existing #building#, provided such #enlargement# contains less #floor area# than the existing #building#, and there is no penetration of #floor area# above a maximum height limit.

\* \* \*

**Chapter 2  
Special Lincoln Square District**

\* \* \*

**82-40  
SPECIAL HEIGHT LIMITATION**

On Block 1 or 2, as indicated on the District Plan in Appendix A of this Chapter, the maximum height of a #building or other structure# shall not exceed 275 feet above #curb level#, except that a penthouse may be located above such height, provided that such penthouse:

- (1) contains not more than four #stories# or 40 feet, whichever is less; and
- (2) the gross area of each #story# does not exceed 80 percent of the gross area of that #story# directly below it.

The underlying allowances for permitted obstructions above such maximum height limit shall apply.

\* \* \*

**Chapter 4**



Special Battery Park City District

\* \* \*

84-10  
ZONE A GENERAL DISTRICT REGULATIONS

\* \* \*

84-13  
Bulk Regulations

\* \* \*

84-135  
Limited height of buildings

For the purposes of this Section, the term “#buildings#” shall include #buildings or other structures#. No portion of any #building# may be built to a height greater than 85 feet above #curb level#, except that:

\* \* \*

(e) ~~Sections 23-62 and 33-42 (Permitted obstructions) are hereby made inapplicable.~~ Any portion of a #building# that exceeds an established height limit shall be subject to the following provisions:

- (1) ~~The obstructions set forth in Sections 23-62 and 33-42, as applicable, along with heliostats, may following shall not be considered obstructions and may thus~~ penetrate a maximum height limit:
  - (i) ~~Chimneys or flues, with a total width not exceeding 10 percent of the #aggregate width of street walls# of a #building# at any level;~~
  - (ii) ~~Elevator or stair bulkheads, roof water tanks, cooling towers and #accessory# mechanical equipment (including enclosure walls), pursuant to Section 33-42;~~
  - (iii) ~~Decks, and other surfaces for recreational activities, not more than 3 feet, 6 inches in height, as measured from the maximum height limit, or the finished level of the roof as it existed on April 30, 2012, whichever is higher;~~
  - (iv) ~~External wall thickness, pursuant to Section 33-42;~~
  - (v) ~~Flagpoles and aerials;~~
  - (vi) ~~Heliostats and wind energy systems;~~
  - (vii) ~~Parapet walls, not more than four feet high in height, as measured from the maximum height limit, or the finished level of the roof as it existed on April 30, 2012, whichever is higher. A guardrail with a surface at least 70 percent open or with an opacity of not more than 30 percent (as viewed in elevation), shall be permitted above a parapet wall or within two feet of a parapet wall, provided such guardrail is not more than four feet above the accessible level of a roof. Such restriction on guardrail height shall not apply when located beyond two feet from a parapet wall;~~

- (viii) ~~Roof thickness, up to eight inches, to accommodate the addition of insulation, for #buildings# or portions of #buildings# constructed prior to April 30, 2012. For a #building# that has added roof thickness pursuant to this paragraph, (c)(1)(viii), an #enlargement# may align with the finished roof surface of such #building#, provided the #enlarged# portion does not exceed the maximum height limit by more than eight inches;~~
  - (ix) ~~Rooftop greenhouses, permitted pursuant to Section 75-01 (Certification for Rooftop Greenhouses);~~
  - (x) ~~Skylights, clerestories or other daylighting devices, not more than four feet in height, as measured from the maximum height limit, or the finished level of the roof as it existed on April 30, 2012, whichever is higher. Such devices shall be limited to a #lot coverage# not greater than 10 percent of the #lot coverage# of the roof and be located at least eight feet from the #street wall# edge. However, such devices shall not be permitted obstructions above a roof with a slope greater than 20 degrees;~~
  - (xi) ~~Solar energy systems:~~
    - (1) ~~on the roof of a #building#, up to four feet in height, as measured from the maximum height limit, or the finished level of the roof, whichever is higher;~~
    - (2) ~~on the roof of a #building#, greater than four feet in height, as measured from the maximum height limit, or the finished level of the roof, whichever is higher, provided that all such portions above four feet are set back at least six feet from a #street wall#, limited to a #lot coverage# not greater than 25 percent of the #lot coverage# of the roof and do not exceed a height of 15 feet, or when located on a bulkhead or other obstruction pursuant to paragraph (f) of Section 33-42, do not exceed a height of six feet;~~
    - (3) ~~on walls existing on April 30, 2012, projecting no more than 10 inches and occupying no more than 20 percent of the surface area of the #building# wall (as viewed in elevation) from which it projects.~~

~~However, any installation on a roof with a slope greater than 20 degrees shall be limited to 18 inches in height, as measured perpendicular to the roof surface;~~
  - (xii) ~~Vegetated roofs, not more than 3 feet, 6 inches in height, excluding vegetation, as measured from the maximum height limit, or the finished level of the roof as it existed on April 30, 2012, whichever is higher. On roofs with slopes greater than 20 degrees, vegetated roofs shall be limited to a height of 12 inches measured perpendicular to such roof surface;~~
  - (xiii) ~~Weirs, check dams and other equipment for stormwater management, not more than 3 feet, 6 inches in height, as measured from the maximum height limit, or the finished level of the roof as it existed on April 30, 2012, whichever is higher;~~
  - (xiv) ~~Wire, chain link or other transparent fences.~~
- (2) The maximum permitted size of enclosure walls surrounding elevator or stair bulkheads, roof water tanks, cooling towers and #accessory# mechanical equipment may be increased by authorization of the City Planning Commission, provided the Commission finds that:

- (i) the width of such additional enclosure wall at each #building# face does not exceed 80 percent of the width of the enclosure wall as allowed in paragraph (e)(1) of this Section;
  - (ii) the additional area of the enclosure wall at each #building# face is not more than 50 percent of the area permitted as-of-right; and
  - (iii) the enclosure wall is compatible with the #building# and the urban design goals of the Special District and complements the design by providing a decorative top; and
- (f) in #special height locations# in Appendices 2.2 and 3.2 of this Chapter, no portion of a #building#, including permitted obstructions, shall exceed a height of 450 feet above #curb level#.

\* \* \*

**84-30  
ZONE C**

\* \* \*

**84-33  
Bulk Regulations**

\* \* \*

**84-333  
Limited height of buildings**

The maximum height of any #building or other structure#, or portion thereof, shall not exceed 400 feet on any portion of subzone C-1 shown as a #special height location# in Appendix 3.2 of this Chapter, except that permitted obstructions, pursuant to Section 33-42, shall be allowed to penetrate a maximum height limit.

The maximum height of any #building or other structure#, or any portion thereof, located within subzone C-2 shall not exceed 180 feet above #curb level#, except that:

- (a) the maximum height of any #building or other structure#, or portion thereof, shown as a #special height location#, shall not exceed the height set forth in Appendix 3.2; and
- (b) ~~Sections 23-62 and 33-42 (Permitted obstructions) are hereby made inapplicable.~~ Any portion of a #building or other structure# that exceeds an established height limit shall be subject to the following provisions:
  - (1) ~~The obstructions set forth in Section 23-62, inclusive, and 33-42, as applicable, may following shall not be considered obstructions and may thus~~ penetrate a maximum height limit:
    - ~~(i) Chimneys or flues, with a total width not exceeding 10 percent of the #aggregate width of street walls# or a #building# at any level;~~
    - ~~(ii) Decks, and other surfaces for recreational activities, not more than 3 feet, 6 inches in height, as measured from the maximum height limit, or the finished level of the roof as it existed on April 30, 2012, whichever is higher;~~

- (iii) — Elevator or stair bulkheads, roof water tanks, cooling towers or other #accessory# mechanical equipment (including enclosure walls), pursuant to Section 33-42;
- (iv) — Fences, wire, chain link or other transparent type;
- (v) — Flagpoles and aerals;
- (vi) — Parapet walls, not more than four feet in height, as measured from the maximum height limit, or the finished level of the roof as it existed on April 30, 2012, whichever is higher. A guardrail with a surface at least 70 percent open or with an opacity of not more than 30 percent (as viewed in elevation), shall be permitted above a parapet wall or within two feet of a parapet wall, provided such guardrail is not more than four feet above the accessible level of a roof. Such restriction on guardrail height shall not apply when located beyond two feet from a parapet wall;
- (vii) — Roof thickness, up to eight inches, to accommodate the addition of insulation, for #buildings# or portions of #buildings# constructed prior to April 30, 2012. For a #building# that has added roof thickness pursuant to this paragraph, (b)(1)(vii), an #enlargement# may align with the finished roof surface of such #building#, provided the #enlarged# portion does not exceed the maximum height limit by more than eight inches;
- (viii) — Rooftop greenhouses, permitted pursuant to Section 75-01 (Certification for Rooftop Greenhouses);
- (ix) — Skylights, clerestories or other daylighting devices, not more than four feet in height, as measured from the maximum height limit, or the finished level of the roof as it existed on April 30, 2012, whichever is higher. Such devices shall be limited to a #lot coverage# not greater than 10 percent of the #lot coverage# of the roof and be located at least eight feet from the #street wall# edge. However, such devices shall not be permitted obstructions above a roof with a slope greater than 20 degrees;
- (x) — Solar energy systems:
  - (a) — on the roof of a #building#, up to four feet in height, as measured from the maximum height limit, or the finished level of the roof, whichever is higher;
  - (b) — on the roof of a #building#, greater than four feet in height, as measured from the maximum height limit, or the finished level of the roof, whichever is higher, provided that all such portions above four feet are set back at least six feet from a #street wall#, limited to a #lot coverage# not greater than 25 percent of the #lot coverage# of the roof and do not exceed a height of 15 feet, or when located on a bulkhead or other obstruction pursuant to paragraph (f) of Section 33-42, do not exceed a height of six feet;
  - (c) — on walls existing on April 30, 2012, projecting no more than 10 inches and occupying no more than 20 percent of the surface area of the #building# wall (as viewed in elevation) from which it projects.

However, any installation on a roof with a slope greater than 20 degrees shall be limited to 18 inches in height, as measured perpendicular to the roof surface;

~~(xi) Vegetated roofs, not more than 3 feet, 6 inches in height, excluding vegetation, as measured from the maximum height limit, or the finished level of the roof as it existed on April 30, 2012, whichever is higher. On roofs with slopes greater than 20 degrees, vegetated roofs shall be limited to a height of 12 inches measured perpendicular to such roof surface;~~

~~(xii) Weirs, check dams and other equipment for stormwater management, not more than 3 feet, 6 inches in height, as measured from the maximum height limit, or the finished level of the roof as it existed on April 30, 2012, whichever is higher.~~

(2) The maximum permitted size of enclosure walls surrounding elevator or stair bulkheads, roof water tanks, cooling towers and #accessory# mechanical equipment may be increased by authorization of the City Planning Commission, provided the Commission finds that:

\* \* \*

**Chapter 5  
Special United Nations Development District**

\* \* \*

[ALLOWING ENERGY GENERATION AND STORAGE TO BE ADDED]

**85-00  
GENERAL PURPOSES**

\* \* \*

**85-05  
Limited Height of Buildings**

The maximum height of a #building or other structure#, including elevator or stair bulkheads, #accessory# water tanks or cooling towers, chimneys, parapets, arbors or trellises and flagpoles, located within the #Special United Nations Development District#, shall not exceed 550 feet above the established grade of the easterly side of Second Avenue midway between East 43rd and East 45th Streets. No portion of any #building# within the #Special United Nations Development District# may be built to a height greater than the present height of the United Nations Secretariat Building within 200 feet west of the westerly boundary of First Avenue. No portion of any #development# on the south side of 44th Street within the #Special United Nations Development District# may be built to a height greater than 183 feet above #curb level# or 15 #stories#, whichever is less. However, #energy infrastructure equipment# and #accessory# mechanical equipment shall be permitted obstructions above all such height limits, subject to the provisions of Section 33-42.

\* \* \*

**Chapter 6  
Special Forest Hills District**

\* \* \*

**86-10  
SPECIAL USE REGULATIONS**

\* \* \*

**86-12  
Modification of Uses Along Austin Street**

The #use# regulations in the #Special Forest Hills District# shall be modified to permit Use Groups 10A, 40C, 12A, 12B, and 12D and 12E within C2 Districts fronting on Austin Street.

The provisions of Section 32-423 (Limitation on ground floor location) shall not apply to #uses# located along Austin Street.

\* \* \*

**Chapter 7  
Special Harlem River Waterfront District**

\* \* \*

**87-30  
SPECIAL HEIGHT AND SETBACK, LEGAL WINDOW AND COURT REGULATIONS**

\* \* \*

**87-31  
Permitted Obstructions**

In the Core and North Subdistricts, the provisions of Section 33-42 (Permitted Obstructions) shall apply to all #buildings#. In addition, dormers may penetrate a maximum base height in accordance with the provisions of paragraph (c)(1) of Section ~~23-621~~ 23-623 (Permitted obstructions in certain districts).

\* \* \*

**87-32  
Special height and Setback Regulatinos in the Core Subdistrict**

\* \* \*

**87-322  
Base heights and transition heights**

In the Core Subdistrict, the following base heights, required setbacks and maximum transition heights shall apply. Towers are permitted above the maximum heights set forth in this Section only in accordance with Section 87-323 (Tower provisions).

\* \* \*

(b) Required setbacks

\* \* \*

Dormers provided in accordance with paragraph (c)(1) of Section ~~23-621~~ 23-623 (Permitted obstructions in certain districts) shall be permitted obstructions in all setback areas, except along the

#shore public walkway#. Such dormers shall not exceed the maximum transition height set forth in paragraph (c) of this Section.

\* \* \*

**87-323  
Tower provisions**

All #stories# that partially or wholly exceed the applicable maximum heights set forth in Section 87-322 (Base heights and transition heights) shall be considered a “tower” and may exceed such transition height only in accordance with the tower provisions of this Section.

\* \* \*

(b) Setbacks

All towers shall comply with the applicable setback provisions set forth in paragraph (b) of Section 87-322.

The dormer provisions of paragraph (c)(1) of Section ~~23-624~~ 23-623 (Permitted obstructions in certain districts) shall not apply to the tower portion of a #building#. In lieu thereof, up to 50 percent of the width of the #street wall# of a tower shall be permitted to encroach into a required setback area, except in setback areas along the #shore public walkway#.

\* \* \*

**Chapter 8  
Special Hudson Square District**

\* \* \*

**88-30  
SPECIAL BULK REGULATIONS**

\* \* \*

**88-33  
Height and Setback**

In the #Special Hudson Square District#, the height and setback regulations of the underlying districts shall not apply. In lieu thereof, the provisions of this Section shall apply to all #buildings#.

(a) ~~Rooftop regulations~~ Permitted obstructions

(1) ~~Permitted obstructions~~

The provisions of Section 33-42 shall apply to all #buildings#, ~~except that elevator or stair bulkheads, roof water tanks, cooling towers or other mechanical equipment (including enclosures), may penetrate a maximum height limit, provided that either the product, in square feet, of the #aggregate width of street walls# of such obstructions facing each #street# frontage, times their average height, in feet, shall not exceed a figure equal to eight times the width, in feet, of the #street wall# of the #building# facing such frontage, or that the #lot coverage# of all such obstructions does not exceed 20 percent of the #lot coverage# of the~~

~~#building#, and the height of all such obstructions does not exceed 40 feet.~~

In addition, dormers may penetrate a maximum base height provided that such dormers comply with the provisions of paragraph (c) of Section ~~23-621~~23-623 (Permitted obstructions in certain districts).

~~(2) Screening requirements for mechanical equipment~~

~~For all #developments#, #enlargements# and #conversions# of #commercial# or #manufacturing# #floor area# to #residences#, all mechanical equipment located on any roof of a #building or other structure# shall be fully screened on all sides. However, no such screening requirements shall apply to water tanks.~~

(b) Height and setback

\* \* \*

**ARTICLE IX  
SPECIAL PURPOSE DISTRICTS**

\* \* \*

**Chapter 1  
Special Lower Manhattan District**

\* \* \*

**91-10  
SPECIAL USE REGULATIONS**

**91-11  
Modification of Use Regulations in C5 Districts**

**91-111  
Additional uses in C5 Districts**

In addition to the special permit #uses# cited in Section 91-06, the #use# regulations for C5 Districts within the #Special Lower Manhattan District# are modified to permit the following #uses#:

From Use Group 7:

Use Groups 7B ~~and 7E~~

From Use Group 8:

Use Groups 8A\*, and 8B ~~and 8E~~

From Use Group 12:

Use Groups 12A\*\*, 12B, and 12C ~~and 12E~~



\* \* \*

**Chapter 2  
Special Park Improvement District**

\* \* \*

**92-00  
GENERAL PURPOSES**

\* \* \*

**92-04  
Special Bulk Provisions**

\* \* \*

**92-043  
Special height limitation**

The maximum height of a #building or other structure#, or portion thereof, shall not exceed 19 #stories# or 210 feet above #curb level#, whichever is less. However, #energy infrastructure equipment# and #accessory# mechanical equipment shall be permitted obstructions above such height limits, subject to the provisions of Sections 23-62, inclusive, or 33-42, as applicable.

\* \* \*

**Chapter 3  
Special Hudson Yards District**

\* \* \*

**93-00  
GENERAL PURPOSES**

\* \* \*

**93-05  
Applicability of District Regulations**

\* \* \*

**93-052  
Applicability of Article I, Chapter 3**

#Public parking lots# authorized prior to January 19, 2005, and #accessory# off-street parking facilities for which a special permit has been granted prior to January 19, 2005, may be renewed subject to the terms of such authorization or special permit.

The provisions of Article I, Chapter 3, in their entirety shall be applied to Subdistricts F and G.

The following provisions of Article I, Chapter 3, governing #automated parking facilities#, ~~as defined in Section 13-02,~~ automobile rental establishments, commercial or public utility vehicle parking, and off-street loading berths shall apply to Subdistricts A, B, C, D and E, as applicable:

- (a) for #automated parking facilities#, the provisions of ~~Section 13-101 (Calculating parking spaces in automated parking facilities),~~ paragraph (b) of Section 13-25 (Reservoir Spaces), ~~and~~ paragraph (b) of Section 13-27 (Minimum and Maximum Size of Parking Facilities), paragraph (a)(3) of Section 36-521 (Size of spaces), and Section 36-524 (Calculating floor area in parking facilities with lift systems, or in automated parking facilities);
- (b) for automobile rental establishments, the provisions of Section 13-15 (Permitted Parking for Automobile Rental Establishments), paragraph (b) of Section 13-221 (Enclosure and screening requirements), Section 13-241 (Location of curb cuts), paragraph (b) of Section 13-242 (Maximum width of curb cuts), paragraph (c) of Section 13-25, and paragraph (c) of Section 13-27;
- (c) for commercial or public utility vehicle parking, the applicable provisions of Section 36-46 (Restrictions on the Use of Accessory Parking Spaces and Spaces in Public Parking Garages and Public Parking Lots), inclusive; ~~13-16 (Permitted Parking for Car Sharing Vehicles and Commercial Vehicles);~~ and
- (d) for off-street loading berths, the provisions of Section 13-30, inclusive.

Additional provisions of Article I, Chapter 3, shall be applicable as specified in Section 93-80, inclusive.

\* \* \*

**93-40  
HEIGHT AND SETBACK REGULATIONS**

\* \* \*

**93-41  
Rooftop Regulations**

- (a) Subdistricts A, B, C, D, E and G

The provisions of Section 33-42 (Permitted obstructions) shall apply to all #buildings# within Subdistricts A through E and G, except that dormers may penetrate a maximum base height in accordance with the provisions of paragraph (c)(1) of Section ~~23-623~~ 23-624 (Permitted obstructions in certain districts).

- (b) Subdistrict F

In Subdistrict F, the provisions of paragraph ~~(f)~~ (b) of Section 33-42 shall apply, except that for towers above a height of 350 feet, in lieu of the provisions of 37-20 (SPECIAL SCREENING AND ENCLOSURE PROVISIONS), inclusive, rooftop mechanical structures shall comply with the tower top articulation provisions set forth in Section 93-569 shall apply.

\* \* \*

**93-50  
SPECIAL HEIGHT, SETBACK AND YARD REGULATIONS**

\* \* \*

**93-55**

**Special Height and Setback Regulations in the South of Port Authority Subdistrict E**

(a) #Zoning lots# with Eighth Avenue frontage

\* \* \*

- (1) any portion of the #building or other structure# #developed# or #enlarged# pursuant to the tower regulations of Sections 33-45 or 35-64, as applicable, may penetrate the #sky exposure plane#;
- (2) permitted obstructions, as listed in paragraph (a) of Section 93-41, may penetrate the #sky exposure plane#. In addition, a dormer, as listed in paragraph (c)(1) of Section ~~23-623~~ ~~23-624~~, may penetrate the #sky exposure plane#.

\* \* \*

**Chapter 7  
Special 125th Street District**

\* \* \*

**97-20  
LOCATION AND ACCESS REGULATIONS**

\* \* \*

**97-21  
Supplemental Use and Streetscape Regulations Along 125th Street**

\* \* \*

**97-212  
Uses not permitted on the ground floor of buildings**

The following #uses# are not permitted within #stories# that have a floor level within five feet of #curb level# in #buildings# #developed# after April 30, 2008, or within #stories# that have a floor level within five feet of #curb level# within portions of #buildings# #enlarged# after April 30, 2008, where such #building# or portion of a #building# fronts upon 125th Street, or is within 100 feet from 125th Street. Entranceways and lobby space for access to such #uses# shall be permitted at the ground floor level, pursuant to the provisions of Section 97-213 (Access to non-ground floor uses).

From Use Group 2:

All #uses#.

From Use Groups 3A ~~and 3B~~:

All #uses#, except for libraries, museums or non-commercial art galleries.

From Use Groups 4A and 4B:

All #uses#, except for houses of worship or playgrounds.

From Use Group 5A:

All #uses#.

From Use Groups 6A, 6B, and 6C ~~and 6E~~:

Banks (except for automated teller machines, provided the width of #street# frontage allocated for automated teller machines shall be no more than 25 feet or 40 percent of the frontage of the #zoning lot#, whichever is less, measured to a depth of 30 feet from 125th Street, except that such frontage need not be less than 20 feet), electrolysis studios, frozen food lockers, laundry establishments, loan offices, offices or veterinary medicine offices.

From Use Group 6D:

All #uses#.

From Use Group 7:

All #uses#, except for bicycle rental or repair shops.

From Use Groups 8A and 8B:

Automobile driving schools, ice vending machines, lumber stores or pawn shops.

From Use Groups 8C, and 8D ~~and 8E~~:

All #uses#.

From Use Groups 9A, and 9B ~~and 9C~~:

All #uses#, except for #health and fitness establishments#, public auction rooms, photographic developing or printing establishments for the consumer, or art, music, dancing or theatrical studios.

From Use Groups 10A, and 10B ~~and 10C~~:

Depositories for storage, and wholesale offices or showrooms.

Use Group 11:

All #uses#.

Use Groups 12A and 12B:

Trade expositions.

Use Groups 12C and 12D:

All #uses#.

Use Group 14A and 14B:

All #uses#, except for bicycle sales, rental or repair shops.

Within the Special District, for such #developments# and #enlargements# that are no more than one #story#, a #use# permitted by the regulations of the underlying district shall be allowed.

\* \* \*

**97-40  
SPECIAL BULK REGULATIONS**

\* \* \*

**97-43  
Special Height and Setback Regulations**

\* \* \*

**97-431  
Permitted obstructions**

The provisions of Section 33-42 (Permitted Obstructions) shall apply, except that dormers may penetrate a maximum base height in accordance with the provisions of paragraph (c)(1) of Section ~~23-621~~ 23-623 (Permitted obstructions in certain districts).

\* \* \*

**Chapter 8  
Special West Chelsea District**

\* \* \*

**98-40  
SPECIAL YARD, HEIGHT AND SETBACK, AND MINIMUM DISTANCE BETWEEN BUILDINGS  
REGULATIONS**

\* \* \*

**98-42  
Special Height and Setback Regulations**

\* \* \*

**98-422  
Special rooftop regulations**

The provisions of Section 33-42 (Permitted Obstructions) shall apply to all #buildings or other structures# within the #Special West Chelsea District#, except that dormers may penetrate a maximum base height in accordance with the provisions of paragraph (c)(1) of Section ~~23-621~~ 23-623 (Permitted obstructions in certain districts). However, dormers may not exceed the maximum #building# height in Subareas C, F and G where the maximum base height and maximum #building# height are the same.

All mechanical equipment located within 15 feet of the level of the #High Line bed# that is within 25 feet of the #High Line#, measured horizontally, or within the #High Line frontage#, as applicable, shall be screened and buffered with no intake or exhaust fans or vents facing directly onto the #High Line#.

\* \* \*

**ARTICLE X  
SPECIAL PURPOSE DISTRICTS**

**Chapter 1  
Special Downtown Brooklyn District**

**101-00  
GENERAL PURPOSES**

\* \* \*

**101-01  
Definitions**

For purposes of this Chapter, matter in italics is defined in Section 12-10 (DEFINITIONS), Section 101-702 (Definitions Specific to the Atlantic Avenue Subdistrict) or in this Section.

[MOVING TO SECTION 12-10]

~~Automated parking facility~~

~~An “automated parking facility” shall refer to an #accessory# off street parking facility or #public parking garage# where vehicular storage and retrieval within such facility is accomplished entirely through a mechanical conveyance system, and shall not refer to a parking facility with parking lift systems that require an attendant to operate the vehicle that is to be parked.~~

Development or to develop

For purposes of this Chapter, “development” includes a #development#, an #enlargement# or an #extension#.

To “develop” is to create a #development#.

\* \* \*

**101-20  
SPECIAL BULK REGULATIONS**

\* \* \*

**101-22  
Special Height and Setback Regulations**

\* \* \*

**101-221  
Permitted obstructions**

The provisions of Section 33-42 (Permitted Obstructions) shall apply to all #buildings# within the #Special Downtown Brooklyn District#, except that dormers may penetrate a maximum base height in accordance with the provisions of paragraph (c)(1) of Section ~~23-624~~ 23-623 (Permitted obstructions in certain districts).

\* \* \*

**101-50  
OFF-STREET PARKING AND OFF-STREET LOADING REGULATIONS**

\* \* \*

**101-53  
Garages**

\* \* \*

[ADDRESSED IN UNDERLYING PROVISIONS]

**101-534  
Stackers in garages**

~~Within an enclosed attended parking facility with parking lift systems, for individual lifted trays upon which a vehicle is stored, each tray upon which a vehicle is stored shall be considered 153 square feet of #floor area#, except if located in portions of a #building# exempt from the definition of #floor area# pursuant to Section 12-10 (DEFINITIONS).~~

**101-535  
Automated parking facilities**

~~For an #automated parking facility#, the minimum size of spaces regulated in Sections 25-62 (Size and Location of Spaces) and 36-521 (Size of spaces) shall not apply.~~

~~For the purpose of calculating parking spaces in #automated parking facilities#, each tray upon which a vehicle is stored shall constitute one off-street parking space. However, auxiliary parking trays may be exempted from constituting a parking space where the Commissioner of Buildings determines that such auxiliary parking trays are needed to routinely store and retrieve vehicles for the efficient operation of such #automated parking facility#.~~

~~Within an #automated parking facility#, each tray upon which a vehicle is stored shall be considered 153 square feet of #floor area#, except if located in portions of a #building# exempt from the definition of #floor area# pursuant to Section 12-10 (DEFINITIONS).~~

**101-536 101-534  
Special permit for public parking garages**

\* \* \*

**Chapter 4  
Special Manhattanville Mixed Use District**

\* \* \*

**104-10  
SPECIAL USE REGULATIONS**

\* \* \*

**104-13  
Commercial and Manufacturing Use Modifications**

\* \* \*

**104-131  
Use Group 6A**

In Subdistrict B, the provisions of Section 42-12 (Use Groups 3A, 6A, 6B, 6D, 6F, 7B, 7C, 7D, ~~7E~~, 8, 9B, ~~9C~~, 10A, 10B, ~~10C~~, 11, 12A, 12C, 12D, ~~12E~~, 13, 14 and 16), shall be modified to permit food stores, including supermarkets, grocery stores or delicatessen stores, without limitation as to #floor area# per establishment.

\* \* \*

**104-30  
SPECIAL HEIGHT AND SETBACK REQUIREMENTS**

\* \* \*

**104-32  
Rooftop Regulations**

The special rooftop regulations of Section 104-32, inclusive, shall apply in Subdistricts A and C.

**104-321  
~~Mechanical~~ Rooftop equipment**

#Energy infrastructure equipment# and #accessory# mechanical ~~Mechanical~~ equipment, other than solar or wind energy systems ~~open or enclosed~~, may be located on the roof of a #building# in accordance with the following provisions:

- (a) #Energy infrastructure equipment# and #accessory# mechanical ~~Mechanical~~ equipment shall not exceed the maximum height for rooftop of ~~mechanical~~ equipment specified for each Parcel as set forth in Appendix B of this Chapter and shall be measured from the roof level of the highest #story# of the #building#. Such ~~mechanical~~ equipment may penetrate the maximum #building# height specified for each Parcel as set forth in Appendix B.
- (b) Such ~~mechanical~~ equipment shall be set back at least 10 feet from the #upper street wall# of the #building#. In addition, such equipment shall not penetrate a #sky exposure plane# that begins at the point of intersection of the roof and the #upper street wall# of the #building#, and rises over the #building# at a slope of 2.7 feet of vertical distance for each foot of horizontal distance, except for permitted obstructions set forth in Section 104-322. Where portions of the #upper street wall# are located at different distances from the #street line# or #mandatory widened sidewalk line#, whichever



is applicable, the portion used to establish such reference line shall be the portion that occupies the greatest area of such #upper street wall#.

- (c) Such ~~mechanical~~ equipment shall not overhang any recess in the #building# wall that is open to the sky.

## 104-322

### Permitted obstructions

The obstructions set forth in Section 33-42, other than the rooftop equipment permitted pursuant to Section 104-321, as well as the following obstructions, ~~following shall not be considered obstructions and thus~~ may penetrate the applicable maximum #building# height and the applicable maximum height for rooftop ~~mechanical~~ equipment set forth in Appendix B of this Chapter, and may also penetrate the #sky exposure plane# set forth in Section 104-321 (~~Mechanical Rooftop~~ equipment). Within 50 feet of the #upper street wall#, the width of such obstructions shall be limited in total to 10 percent of the #aggregate width of street walls# of a #building#, per #street# frontage, at any level above the maximum level of rooftop ~~mechanical~~ equipment as set forth in Section 104-321. Beyond 50 feet from the #upper street wall#, the permitted obstructions may occupy an area not to exceed 30 percent of the #building# coverage at the ground level. Where portions of the #upper street wall# are located at different distances from the #street line# or #mandatory widened sidewalk line#, whichever is applicable, the portion used to establish such reference line shall be the portion that occupies the greatest area of such #upper street wall#. However, in no event shall such obstructions be located within 10 feet of the #upper street wall#.

- (a) Antennae and structural support thereto;
- ~~(b) Chimneys, flues, intake and exhaust vents limited to a #lot coverage# of 900 square feet with neither length nor width of any single such obstruction, nor the total length or width of all such obstructions, greater than 30 feet;~~
- ~~(c) Decks, and other surfaces for recreational activities, not more than 3 feet, 6 inches in height, as measured from the maximum height limit, or the finished level of the roof as it existed on April 30, 2012, whichever is higher;~~
- ~~(d) Elevator and stair bulkheads to a maximum height of 15 feet above the permitted maximum height of mechanical equipment;~~
- ~~(e) Flagpoles or aerials;~~
- ~~(f) House of worship towers, ornamental, having no #floor area# in portion of tower penetrating such #sky exposure plane#;~~
- ~~(g) Parapet walls, not more than four feet in height, as measured from the maximum height limit, or the finished level of the roof as it existed on April 30, 2012, whichever is higher. A guardrail with a surface at least 70 percent open or with an opacity of not more than 30 percent (as viewed in elevation), shall be permitted above a parapet wall or within two feet of a parapet wall, provided such guardrail is not more than four feet above the accessible level of a roof. Such restriction on guardrail height shall not apply when located beyond two feet from a parapet wall;~~
- ~~(h)(b)~~ Pipes and supporting structures;
- ~~(i)(c)~~ Railings;

- (j) ~~Roof thickness, up to eight inches, to accommodate the addition of insulation, for #buildings# or portions of #buildings# constructed prior to April 30, 2012. For a #building# that has added roof thickness pursuant to this paragraph (j), an #enlargement# may align with the finished roof surface of such #building#, provided the #enlarged# portion does not exceed the maximum height limit by more than eight inches;~~
- (k) ~~Rooftop greenhouses, permitted pursuant to Section 75-01 (Certification for Rooftop Greenhouses);~~
- (l) ~~Skylights, clerestories or other daylighting devices, not more than four feet in height, as measured from the maximum height limit, or the finished level of the roof as it existed on April 30, 2012, whichever is higher. Such devices shall be limited to a #lot coverage# not greater than 10 percent of the #lot coverage# of the roof and be located at least eight feet from the #street wall# edge. However, such devices shall not be permitted obstructions above a roof with a slope greater than 20 degrees;~~
- (m) ~~Solar energy systems:~~
- (1) ~~on the roof of a #building#, up to four feet in height, as measured from the maximum height limit, or the finished level of the roof, whichever is higher;~~
- (2) ~~on the roof of a #building#, greater than four feet in height, as measured from the maximum height limit, or the finished level of the roof, whichever is higher, provided that all such portions above four feet are set back at least six feet from a #street wall#, limited to a #lot coverage# not greater than 25 percent of the #lot coverage# of the roof and do not exceed:~~
- (i) ~~a height of 15 feet; and~~
- (ii) ~~when located on a bulkhead or other obstruction, pursuant to paragraph (d) of this Section, a height of six feet;~~
- (3) ~~on walls existing on April 30, 2012, projecting no more than 10 inches and occupying no more than 20 percent of the surface area of the #building# wall (as viewed in elevation) from which it projects;~~
- ~~However, any installation on a roof with a slope greater than 20 degrees shall be limited to 18 inches in height, as measured perpendicular to the roof surface;~~
- (n) ~~Spires or belfries;~~
- (o) ~~Vegetated roofs, not more than 3 feet, 6 inches in height excluding vegetation, as measured from the maximum height limit, or the finished level of the roof as it existed on April 30, 2012, whichever is higher. On roofs with slopes greater than 20 degrees, vegetated roofs shall be limited to a height of 12 inches measured perpendicular to such roof surface;~~
- (p) ~~Weirs, check dams and other equipment for stormwater management, not more than 3 feet, 6 inches in height, as measured from the maximum height limit, or the finished level of the roof as it existed on April 30, 2012, whichever is higher;~~
- (q) ~~Window washing equipment mounted on the roof;~~
- (r) ~~Wire, chain link or other transparent fences.~~

**Appendix B  
Base Plane and Building Height Table**

Parcel*	#Base Plane#** (in feet)	Maximum #Building# Height** Above #Base Plane# (in feet)	Maximum Height of <del>Mechanical Rooftop</del> Equipment (in feet)
A	21.6	140	40
		*	*

\* \* \*

**Chapter 5  
Special Natural Area District**

\* \* \*

**105-01  
Definitions**

Definitions specially applicable to this Chapter are set forth in this Section. The definitions of other defined terms are set forth in Section 12-10 (DEFINITIONS).

Area of no disturbance

An "area of no disturbance" is an area designated on the site plan that is protected from all types of intrusion, including: #site alteration#, operation of construction equipment, storage of construction materials, excavation or regrading, tunneling for utilities, removal of trees, #topsoil# or any living vegetation, or construction of driveways, #private roads#, parking areas, patios, decks, swimming pools, walkways or other impervious surfaces including any surfaces with permeable paving. #Areas of no disturbance# shall include #steep slopes#, #steep slope buffers# and the #critical root zone# of each tree proposed for preservation.

\* \* \*

**Chapter 7  
Special South Richmond Development District**

\* \* \*

**107-20  
DISTRICT PLAN ELEMENTS**

\* \* \*

**107-22  
Designated Open Space**

\* \* \*

**107-223  
Permitted obstruction in designated open space**

The following shall not be considered as obstructions when located in #designated open space#:

\* \* \*

- (d) Fences or walls, conditioned upon certification by the City Planning Commission that:
  - (1) such fences or walls will not obstruct or preclude public access or circulation of pedestrians, cyclists or horseback riders through the public easement within #designated open space#; and
  - (2) the location, size, design and materials of such fences or walls are appropriate to the character of the #designated open space#;
- (e) ~~Exterior wall thickness~~ #Qualifying exterior wall thickness#, pursuant to Section 23-44;
- (f) Solar energy systems on walls, pursuant to Section 23-44 existing on April 30, 2012, projecting no more than 10 inches and occupying no more than 20 percent of the surface area of the #building# wall (as viewed in elevation) from which it projects.

No #accessory# off-street parking facilities shall be permitted in #designated open space#. No #building or other structure# shall be erected in #designated open space# except as permitted by the provisions of Section 107-221 (Active recreational facilities). Any existing #building or other structure# located within the #designated open space# on September 11, 1975, and not complying with the provisions of this Section or the other Sections specified in the preceding paragraph, shall not be #enlarged# but may be continued as a #non-conforming# #use# or #non-complying# #building# subject to the applicable provisions of Article V (Non-conforming Uses and Non-complying Buildings) in accordance with the underlying district regulations.

\* \* \*

**107-40  
SPECIAL USE, BULK AND PARKING REGULATIONS**

\* \* \*

**107-48  
Special Landscaping and Buffering Provisions**

\* \* \*

**107-483  
Planting and screening for open parking areas**

- (a) Tree planting requirements
 

One tree, of three inch caliper or more, pre-existing or newly planted, shall be provided for each four parking spaces. Such trees may be located in the perimeter landscaped area of the parking area or in planting islands within the parking area.

However, where 30 or more parking spaces are provided, at least 50 percent of the required trees shall be located within planting islands within the parking area. Such planting islands shall have a minimum area of 150 square feet of pervious surface and comply with the requirements of paragraphs (a), (b) and (c) of Section 37-922 (Interior landscaping).

For open parking areas with at least 36 parking spaces, the total number of trees required pursuant to

Section 37-922 (Interior landscaping) shall be superseded by the number of trees required pursuant to this Section.

Notwithstanding the above, For open parking areas where solar canopies will cover more than 75 percent of the parking spaces in a #accessory# off-street parking facility or #public parking lot#, or any portion thereof with more than 10 parking spaces, the provisions of Section 37-923 (Alternative compliance for solar canopies), including associated applicability and modifications to the provisions of Sections 37-921 (Perimeter landscaping) and 37-922, may be applied in lieu of the provisions of this Section.

(b) Screening requirements

\* \* \*

**107-60  
AUTHORIZATIONS**

\* \* \*

**107-67  
Uses and Bulk Permitted in Certain Areas**

\* \* \*

**107-671  
In Areas F and K**

In Areas F and K, as shown in the District Plan (Map 4 in Appendix A), the City Planning Commission may authorize one or more #uses# in the Use Groups specified in this Section not permitted by the underlying district regulations.

\* \* \*

In each case the Commission may prescribe additional conditions and safeguards, including requirements for adequate screening, planting or landscaping.

Areas (as designated on the District Map)	Permitted Use Groups
F	12
K	7A 7B 7D 7E

\* \* \*

**Chapter 9  
Special Little Italy District**

\* \* \*

**109-10**

**PRESERVATION AREA (Area A)**

\* \* \*

**109-12  
Bulk Regulations**

\* \* \*

**109-124  
Height and setback regulations**

The maximum height of any #building or other structure# shall not exceed 75 feet or seven #stories# above the #curb level#, whichever is less, unless allowed by the City Planning Commission pursuant to Section 109-514.

~~However, the provisions of this Section shall not apply to #enlargements# if, prior to February 2, 2011, a building permit has been lawfully issued authorizing such construction.~~

However, #energy infrastructure equipment# and #accessory# mechanical equipment shall be permitted obstructions above such height limits, subject to the provisions of Section 33-42.

\* \* \*

**109-30  
HOUSTON STREET CORRIDOR (Area B)**

\* \* \*

**109-32  
Bulk Regulations**

\* \* \*

**109-323  
Height and setback regulations**

The maximum permitted height of a #street wall# at the #street line# without setback shall not exceed 100 feet above #curb level# and, above this height, no portion of a #building or other structure# shall penetrate a #sky exposure plane# commencing at 100 feet and rising over the #zoning lot# at a ratio of 1.5 to 1.0.

In addition, no portion of a #building or other structure# shall penetrate a #rear sky exposure plane# commencing at a height of 100 feet above #curb level# and at a distance of 100 feet from and parallel to the #street line#, and rising over the #zoning lot# at a ratio of 1.5 to 1.0 along #wide streets# and at a ratio of 1.0 to 1.0 along #narrow streets#.

However, #energy infrastructure equipment# and #accessory# mechanical equipment shall be permitted obstructions above such height limits, subject to the provisions of Section 33-42.

\* \* \*

**ARTICLE XI  
SPECIAL PURPOSE DISTRICTS**

**Chapter 1  
Special Tribeca Mixed Use District**

\* \* \*

**111-20  
SPECIAL BULK PROVISIONS FOR AREAS A1 THROUGH A7**

\* \* \*

(d) Areas A4, A5, A6 and A7

\* \* \*

(2) The provisions of Section 33-42 (Permitted Obstructions) shall apply to all #buildings#, except that dormers may penetrate a maximum base height in accordance with the provisions of paragraph (c)(1) of Section ~~23-621~~ 23-623 (Permitted obstructions in certain districts).

\* \* \*

**Chapter 4  
Special Bay Ridge District**

\* \* \*

**114-10  
SPECIAL BULK REGULATIONS**

\* \* \*

**114-12  
Special Height and Setback Regulations**

**114-121  
Special rooftop regulations**

The provisions of Section 33-42 (Permitted Obstructions) shall apply to all #buildings or other structures# in R6A, R6B, R7A, R7B, C4-2A and C8-2 Districts in the #Special Bay Ridge District#, except that dormers may penetrate a maximum base height in accordance with the provisions of paragraph (c)(1) of Section ~~23-621~~ 23-623 (Permitted obstructions in certain districts).

**114-122  
Maximum building height and setback**

In the #Special Bay Ridge District#, the height and setback and maximum #building# height regulations of the underlying districts have been modified as follows:

\* \* \*

(b) For #community facilities# in #Residence Districts#

In R3A, R3X, R3-2, R4A, R4-1, R4B and R5B Districts, the maximum height of a #building or other structure# containing #community facility uses# shall not exceed 32 feet.

However, #energy infrastructure equipment# and #accessory# mechanical equipment shall be permitted obstructions above such height limits, subject to the provisions of Sections 24-51 or 33-42, as applicable.

\* \* \*

**Chapter 5  
Special Downtown Jamaica District**

\* \* \*

**115-10  
SPECIAL USE REGULATIONS**

\* \* \*

**115-15  
Modification of Use Regulations in M1-4 Districts**

\* \* \*

Use Groups 6 and 10

All #uses# listed in Sections 32-15 (Use Group 6) and 32-19 (Use Group 10), shall be permitted and shall not be subject to the limitations specified in Section 42-12 (Use Groups 3A, 6A, 6B, 6D, 6F, 7B, 7C, 7D, ~~7E~~, 8, 9B, ~~9C~~, 10A, 10B, ~~10C~~, 11, 12A, 12C, 12D, ~~12E~~, 13, 14 and 16).

\* \* \*

From Use Group 18:

Breweries, limited to 10,000 square feet of #floor area# per establishment

#Uses# #accessory# to the preceding listed #uses#

\* \* \*

**115-20  
SPECIAL BULK REGULATIONS**

\* \* \*

**115-23  
Height and Setback Regulations**

\* \* \*



**115-231  
Permitted obstructions**

The provisions of Section 33-42 (Permitted Obstructions) shall apply to all #buildings# within the #Special Downtown Jamaica District#, except that dormers may penetrate a maximum base height in accordance with the provisions of paragraph (c)(1) of Section ~~23-624~~ 23-623 (Permitted obstructions in certain districts).

\* \* \*

**Chapter 6  
Special Stapleton Waterfront District**

\* \* \*

**116-20  
SPECIAL BULK REGULATIONS FOR SUBAREAS A, B AND C, THE ESPLANADE, PIER PLACE AND THE COVE**

The special #bulk# regulations of Section 116-20, inclusive, shall apply to Subareas A, B and C, the #Esplanade#, #Pier Place# and the #Cove#.

\* \* \*

**116-23  
Special Height and Setback Regulations**

\* \* \*

**116-231  
Special rooftop regulations**

The provisions of Section 33-42 (Permitted Obstructions) shall apply to all #buildings or other structures# in Subareas A, B and C, except that dormers may penetrate a maximum base height in accordance with the provisions of paragraph (c)(1) of Section ~~23-624~~ 23-623 (Permitted obstructions in certain districts).

\* \* \*

**116-233  
Height and setback**

Within the #Special Stapleton Waterfront District#, the underlying height and setback regulations shall be modified as follows:

- (a) Subareas A and B1

\* \* \*

- (3) Dormer provisions

The underlying dormer provisions of paragraph (c) of Section ~~23-624~~ 23-623 (Permitted obstructions in certain districts) shall apply, except that no dormer shall be permitted above a height of 85 feet, or above the maximum height of the #building or other structure# permitted in paragraph (a) of this Section, whichever is lower.

\* \* \*

**Chapter 7  
Special Long Island City Mixed Use District**

\* \* \*

**117-20  
SPECIAL PROVISIONS IN THE DESIGNATED DISTRICTS**

\* \* \*

**117-22  
Modification of Use Group 6A**

M1-4/R6A M1-4/R6B M1-4/R7A M1-5/R7X M1-5/R8A

The provisions of Section 42-12 (Use Groups 3A, 6A, 6B, 6D, 6F, 7B, 7C, 7D, ~~7E~~, 8, 9B, ~~9C~~, 10A, 10B, ~~10C~~, 11, 12A, 12C, 12D, ~~12E~~, 13, 14 and 16) pertaining to Use Group 6A shall be modified as follows:

Food stores, including supermarkets, grocery stores or delicatessen stores, shall not be limited as to #floor area# per establishment.

\* \* \*

**117-60  
DUTCH KILLS SUBDISTRICT**

\* \* \*

**117-62  
Special Use Regulations**

In the Dutch Kills Subdistrict, the provisions of Section 42-12 (Use Groups 3A, 6A, 6B, 6D, 6F, 7B, 7C, 7D, ~~7E~~, 8, 9B, ~~9C~~, 10A, 10B, ~~10C~~, 11, 12A, 12C, 12D, ~~12E~~, 13, 14 and 16) shall be modified to permit food stores, including supermarkets, grocery stores or delicatessen stores, without limitation as to #floor area# per establishment.

\* \* \*

**Chapter 8  
Special Union Square District**

\* \* \*

**118-30  
STREET WALL, HEIGHT AND SETBACK REGULATIONS**

\* \* \*

No #development# or #enlargement# shall penetrate such #sky exposure plane# except pursuant to Section 33-45 (Tower Regulations). However, Section 33-45 shall not be applicable to any portion of a #building# located within 100 feet of a #street line# opposite a #public park#.

However, #energy infrastructure equipment# and #accessory# mechanical equipment shall be permitted obstructions above such height limits, subject to the provisions of Section 33-42.

**118-31  
Modification of Street Wall Requirements**

\* \* \*

**Chapter 9  
Special Hillside Preservation District**

\* \* \*

**119-01  
Definitions**

Definitions specially applicable to this Chapter are set forth in this Section. The definitions of other defined terms are set forth in Section 12-10 (DEFINITIONS).

Area of no disturbance

An "area of no disturbance" is an area designated on the site plan that is protected from all types of intrusion, including: #site alteration#, operation of construction equipment, storage of construction materials, excavation or regrading, tunneling for utilities, removal of trees, #topsoil# or any living vegetation, or construction of driveways, #private roads#, parking areas, patios, decks, swimming pools, walkways or other impervious surfaces, including any surfaces with permeable paving. #Areas of no disturbance# shall include #steep slopes#, #steep slope buffers# and the #critical root zone# of each tree proposed for preservation.

\* \* \*

**ARTICLE XII  
SPECIAL PURPOSE DISTRICTS**

**Chapter 1  
Special Garment Center District**

\* \* \*

**121-40  
SPECIAL BULK REGULATIONS WITHIN SUBDISTRICT A-2**

\* \* \*

**121-42  
Height of Street Walls and Maximum Building Height Within Subdistrict A-2**

\* \* \*

(b) Maximum #building# height

\* \* \*

- (2) permitted obstructions, as listed in Section 33-42, may penetrate the #sky exposure plane# and the height limit of 250 feet. In addition, a dormer, as listed in paragraph (c)(1) of Section ~~23-624~~ 23-623 (Permitted obstructions in certain districts), may penetrate the #sky exposure plane#.

\* \* \*

**Chapter 4**  
**Special Willets Point District**

\* \* \*

**124-20**  
**BULK REGULATIONS**

\* \* \*

**124-22**  
**Height and Setback Regulations**

\* \* \*

- (b) Required setbacks and maximum #building# height

Except as provided in paragraph (c)(6) of this Section, setbacks are required for all portions of #buildings or other structures# that exceed a height of 85 feet. Such setbacks shall be provided at a height not lower than 60 feet. The depth of the required setback shall be at least 10 feet measured from any required #street wall# fronting on a #wide street#, and at least 15 feet from any required #street wall# fronting on a #narrow street#. Where portions of #buildings or other structures# that exceed a height of 85 feet are not located above a required #street wall#, such portions shall be set back at least 10 feet from a #wide# #street line# and at least 15 feet from a #narrow# #street line#. However, dormers may penetrate a height of 85 feet in accordance with the provisions of paragraph (c) of Section ~~23-624~~ 23-623 (Permitted obstructions in certain districts). Within the area limited to 232 feet above mean sea level, as shown on Map 3 in the Appendix to this Chapter, no portion of a #building or other structure# shall exceed a height of 120 feet except in accordance with the tower provisions of paragraph (c) of this Section.

\* \* \*

**Chapter 5**  
**Special Southern Hunters Point District**

\* \* \*

**125-30**  
**HEIGHT AND SETBACK REGULATIONS**

\* \* \*

**125-31**  
**Rooftop Regulations**

The provisions of Section 33-42 (Permitted Obstructions) shall apply to all #buildings# within the #Special Southern Hunters Point District#, except that dormers may penetrate a maximum base height in accordance with the provisions of paragraph (c)(4) of Section ~~23-621~~ 23-623 (Permitted obstructions in certain districts).

\* \* \*

**Chapter 6  
Special College Point District**

\* \* \*

**126-10  
SPECIAL USE REGULATIONS**

\* \* \*

**126-11  
Recreational Uses**

The regulations of Section 42-10 (USES PERMITTED AS-OF-RIGHT), shall be modified to allow the following #uses# as-of-right within the #Special College Point District#:

From Use Group 4A:

Non-commercial recreation centers

From Use Group 4B:

Golf courses

Outdoor tennis courts or ice skating rinks, provided that all lighting shall be directed away from nearby #residences#

#Public parks#, playgrounds or private parks

~~From Use Group 4C:~~

~~#Accessory# #uses#~~

**126-12  
Performance Standards**

\* \* \*

**Chapter 8  
Special St. George District**

\* \* \*

**128-30  
HEIGHT AND SETBACK REGULATIONS**

\* \* \*

**128-31  
Rooftop Regulations**

The provisions of Section 33-42 (Permitted Obstructions) shall apply to all #buildings#, except that dormers may penetrate a maximum base height in accordance with the provisions of paragraph (c)(1) of Section ~~23-621~~ 23-623 (Permitted obstructions in certain districts).

\* \* \*

**128-33  
Maximum Base Height**

In C4-2 Districts within the Upland Subdistrict and in R7-3 Districts, dormers may exceed the maximum base height in accordance with the provisions of paragraph (c) of Section ~~23-621~~ 23-623 (Permitted obstructions in certain districts). However, on any #zoning lot# that includes a tower #developed# or #enlarged# pursuant to Section 128-35, dormers shall not be permitted.

\* \* \*

**128-60  
SPECIAL APPROVALS**

\* \* \*

**128-61  
Special Permit for North Waterfront Sites**

\* \* \*

Pursuant to such Proposed Plans, the Commission may:

- (a) permit the following #uses# :
  - (1) #commercial# #uses# as set forth in Section 42-12 (Use Groups 3A, 6A, 6B, 6D, 6F, 7B, 7C, 7D, ~~7E~~, 8, 9B, ~~9C~~, 10A, 10B, ~~10C~~, 11, 12A, 12C, 12D, ~~12E~~, 13, 14 and 16) with no limitation on #floor area# per establishment;

\* \* \*

**ARTICLE XIII  
SPECIAL PURPOSE DISTRICTS**

**Chapter 1  
Special Coney Island District**

\* \* \*

**131-10  
SPECIAL USE REGULATIONS**

\* \* \*

**131-13  
Special Use Regulations in Subdistricts**

\* \* \*

**131-132  
Coney North and Coney West Subdistricts**

\* \* \*

(b) Prohibited ground floor level #uses# along #streets# other than Riegelmann Boardwalk

No #use# listed in this paragraph, (b), shall be permitted within 50 feet of a #street# specified on Map 2. Lobbies or entryways to non-ground floor level #uses# are permitted, provided the length of #street# frontage occupied by such lobbies or entryways does not exceed, in total, 60 feet.

From Use Group 2:

All #uses#

From Use Groups 3A and 3B:

All #uses#, except for libraries, museums or non-commercial art galleries

From Use Groups 4A and 4B:

All #uses#, except for houses of worship or playgrounds

From Use Group 5A:

All #uses#, except that #transient hotels# shall be permitted within 200 feet of Surf Avenue between Stillwell Avenue and West 16th Street, where permitted pursuant to Section 32-02

From Use Groups 6B, and 6E:

Offices, veterinary medicine offices or non-commercial clubs

From Use Group 6C:

Banks (except for automated teller machines, provided the length of #street# frontage allocated for automated teller machines shall be no more than 25 feet or 40 percent of the frontage of the #zoning lot#, whichever is less, except such frontage need not be less than 20 feet), except that this prohibition shall not apply along Stillwell Avenue

Electrolysis studios, frozen food lockers and loan offices

From Use Group 6D:

All #uses#

From Use Group 7:

All #uses#, except for bicycle rental or repair shops

From Use Groups 8A and 8B:

Automobile driving schools, ice vending machines, lumber stores or pawn shops

From Use Groups 8C, and 8D ~~and 8E~~:

All #uses#

From Use Groups 9A, and 9B ~~and 9C~~:

All #uses#, except for #health and fitness establishments#, public auction rooms, photographic developing or printing establishments for the consumer, or art, music, dancing or theatrical studios

From Use Groups 10A, and 10B ~~and 10C~~:

Depositories for storage, and wholesale offices or showrooms

Use Group 11:

All #uses#

Use Groups 12A and 12B:

Trade expositions

Use Groups 12C and 12D:

All #uses#

Use Groups 14A and 14B:

All #uses#, except for bicycle sales, rental or repair shops.

\* \* \*

**131-40  
HEIGHT AND SETBACK REGULATIONS**

\* \* \*

**131-41  
Rooftop Regulations**

The provisions of Section 33-42 (Permitted Obstructions) shall apply to all #buildings# within the #Special Coney Island District#, except that dormers may penetrate a maximum base height in accordance with the provisions of paragraph (c)(4) of Section ~~23-624~~ 23-623 (Permitted obstructions in certain districts) only in the Mermaid Avenue Subdistrict.



\* \* \*

**Chapter 3  
Special Southern Roosevelt Island District**

\* \* \*

**133-20  
SPECIAL BULK REGULATIONS**

\* \* \*

**133-23  
Height and Setback**

\* \* \*

**133-234  
Permitted obstructions**

Sections 23-62, 24-51 and 33-42 (Permitted obstructions) shall be modified to allow ~~#accessory# energy generating systems~~ #energy infrastructure equipment# and #accessory# mechanical equipment on the roof of a #building#, or any other structures supporting such systems, as permitted obstructions, without limitations.

\* \* \*

**Chapter 4  
Special Governors Island District**

\* \* \*

**134-20  
SPECIAL BULK REGULATIONS**

\* \* \*

**134-24  
Height and Setback Regulations**

\* \* \*

(b) Southern Subdistrict

\* \* \*

(4) Permitted obstructions in the Eastern Subarea and Western Subarea

In the Eastern Subarea and Western Subarea, the provisions of Section 33-42 (Permitted Obstructions) shall apply to all #buildings#, modified as follows:

- (i) the obstructions permitted by paragraph ~~(b)~~ of Section 33-42 may exceed the maximum #building# height by 40 feet with no restriction on area; and
- (ii) no such obstructions shall be permitted within the setback required by paragraph

(b)(2) of this Section.

\* \* \*

**Chapter 5  
Special Bay Street Corridor District**

\* \* \*

**135-10  
SPECIAL USE REGULATIONS**

\* \* \*

**135-14  
Modification of Supplemental Use Provisions**

In Subdistricts A, B and C, the underlying provisions of Section 32-421 (Limitation on floors occupied by commercial uses) shall be modified as follows:

- (a) For #mixed buildings#, offices, as listed in Use Group 6B, shall be permitted on the lowest two #stories# of a #building#, provided that no access exists between such offices and any #residential uses#;
- (b) For #commercial buildings#, the provisions restricting the location of #uses# listed in Use Groups 6A, 6B, 6C, ~~6E~~, 7, 8, 9 or 14 to two #stories#, shall not apply; and
- (c) Any brewery #developed# or #enlarged# in accordance with the provisions of Section 135-14, shall be subject to the provisions of Section 32-421.

\* \* \*

**135-20  
SPECIAL BULK REGULATIONS**

\* \* \*

**135-25  
Special Height and Setback Regulations**

The underlying height and setback provisions are modified by the provisions of this Section.

Pursuant to Section 135-31 (Special Visual Corridor Requirements), required visual corridors shall be considered #streets#. Such visual corridors shall be considered #wide streets# for the purposes of applying the height and setback regulations of this Section.

\* \* \*

- (d) Dormer provisions

The underlying dormer provisions of paragraph (c) of Section ~~23-624~~ 23-623 (Permitted obstructions in certain districts) shall apply, except that no dormer shall be permitted above a height of 85 feet, or above the maximum height of the #building or other structure# permitted in paragraph (a) of this Section, whichever is less.

\* \* \*

**Chapter 6  
Special Downtown Far Rockaway District**

\* \* \*

**136-30  
SPECIAL REGULATIONS WITHIN SUBDISTRICT A**

\* \* \*

**136-31  
Special Height and Setback Regulations Within Subdistrict A**

\* \* \*

**136-313  
Minimum and maximum base height**

\* \* \*

(b) Dormers

The provisions of paragraph (c) of Section ~~23-621~~ 23-623 (Permitted obstructions in certain districts) shall be modified to allow dormers as a permitted obstruction within the required front setback distance above a maximum base height, as follows:

- (1) Within 75 feet of intersecting #streets#, dormers shall be permitted without limitation on width.
- (2) Where dormers are provided pursuant to paragraph (b)(1) of this Section, and such dormers exceed the maximum width permitted pursuant to paragraph (c) of Section ~~23-621~~ 23-623, for any portion of a #building# with an #aggregate width of street walls# greater than 75 feet, a setback shall be provided above the maximum base height between such dormer and any other dormer for a width of at least 20 feet, or the remaining width of such #street wall#, as applicable.
- (3) Beyond 75 feet of intersecting #streets#, the provisions of paragraph (c) of Section ~~23-621~~ 23-623 shall apply. The width of any dormers provided pursuant to the provisions of paragraph (b)(1) of this Section shall be included in the aggregate width of all dormers.

\* \* \*

**Chapter 9:  
Special Gowanus Mixed Use District**

\* \* \*

**139-20  
SPECIAL BULK REGULATIONS**

\* \* \*

**139-22  
Special Yard Regulations**

\* \* \*

**139-221  
Permitted obstructions in required yards**

In all #Commercial#, #Manufacturing#, and #Mixed Use Districts#, the permitted obstruction provisions of paragraph (b)(~~3~~)(2) of Section 33-23 and paragraph (b)(1) of Section 43-23 shall be modified such that, in any #rear yard#, any #building# or portion of a #building# used for any permitted non-#residential use# (except any #building# portion containing rooms used for living or sleeping purposes) shall be a permitted obstruction, provided that the height of such #building#, or portion thereof, shall not exceed two #stories#, excluding #basements#, nor in any event 30 feet above #curb level#. Any allowance for other permitted obstructions above a #building# in a #rear yard# or #rear yard equivalent# set forth in Section 33-23 or 44-23, as applicable, shall be permitted above such modified height limitations.

\* \* \*

**139-23  
Special Height and Setback Regulations**

\* \* \*

**139-237  
Special street wall articulation requirements**

\* \* \*

In addition, in Subdistrict D, the underlying dormer provisions of paragraph (c) of Section ~~23-624~~ 23-623 shall be modified for portions of #buildings# facing Third Street, so that above the maximum base height, dormers shall be permitted only within 75 feet of the intersection of two #streets#.

\* \* \*

**139-30  
SPECIAL PARKING REGULATIONS**

\* \* \*

**139-31  
Special Accessory Off-street Parking Regulations**

\* \* \*

**139-315  
Use of parking facilities for car sharing vehicles**

[UNNECESSARY, COVERED BY UNDERLYING REGULATIONS]

~~The underlying regulations regarding the occupation of #accessory# or required off-street parking spaces by #car sharing vehicles# shall be modified so that, in all districts, the number of spaces occupied by #car sharing vehicles# shall not exceed 20 percent of all spaces in a #group parking facility#.~~

**139-316**

**Use of parking facilities for public parking**

All #accessory# off-street parking spaces may be made available for public use. However, parking spaces #accessory# to #residences# shall be made available to the occupant of a #residence# to which it is #accessory# within 30 days after written request is made to the landlord.

**139-32**

**Special Permitted Off-street Parking Regulations**

\* \* \*

**139-232**

**Permitted obstructions**

In all districts, the underlying permitted obstruction regulations shall be modified by this Section.

[UNNECESSARY, COVERED BY UNDERLYING REGULATIONS]

~~(a)~~ (a) Solar energy systems

~~The underlying permitted obstruction regulations shall be modified to permit solar energy systems as a permitted obstruction up to a #lot coverage# of 100 percent of the #lot coverage# of the roof.~~

~~(b)~~(a) Balconies

Unenclosed balconies complying with the provisions of Section 23-132 (Balconies in R6 through R10 Districts) may encroach into any required open area on the #zoning lot#. However, balconies that encroach into #waterfront public access areas# shall be regulated by the provisions of paragraph (a)(1) Section 139-51 (Area-wide Modifications).

~~(c)~~(b) Dormers

Above the maximum base height, dormers shall be permitted to encroach into a required setback area, except setback areas adjoining tower portions of #buildings# and setback areas facing #waterfront public access areas#, provided that:

\* \* \*

[UNNECESSARY, COVERED BY UNDERLYING REGULATIONS]

~~139-32~~

~~Special Permitted Off-street Parking Regulations~~

~~For portions of an #automated parking facility#, as that term is defined in Section 13-02, each tray upon which a vehicle is stored shall be considered one parking space, regardless of its size. In addition, at a height in excess of 23 feet above #curb level# each parking tray shall be considered #floor area# in an amount of 153 square feet or the size of such lifted tray, whichever is greater.~~

~~139-33~~

~~139-32~~

~~Special Loading Regulations~~

~~\* \* \*~~

139-40

DISTRICT PLAN ELEMENTS

\* \* \*

139-42

Street Tree Requirements

In all districts, all #developments#, or #enlargements# that increase the #floor area# on a #zoning lot# by 20 percent or more, shall provide #street# trees in accordance with Section 26-41 (Street Tree Planting).

~~In addition, for #zoning lots# with over 100 feet of street frontage, wherever two required #street# tree pits will be separated by less than 25 feet, such tree pits shall be combined and designed as a single continuous tree pit.~~

139-43

Sidewalk Widening Requirements

\* \* \*

Article XIV - Special Purpose Districts

Chapter 1

Special Jerome Corridor District

\* \* \*

141-20

SPECIAL BULK REGULATIONS

\* \* \*

141-21

Special Yard Regulations

In #Commercial Districts#, for #zoning lots# or portions thereof, with #street lines# along the elevated rail structure on Jerome or River Avenues and within 100 feet of such #street lines#, the permitted obstructions set forth in Section 33-23 (Permitted Obstructions in Required Yards or Rear Yard Equivalents) shall be modified

to permit any #building# or portion of a #building# used for any permitted #use# other than #residences#, to be a permitted obstruction within a required #yard#, #rear yard equivalent# or other #open space# required pursuant to the provisions of Section 33-20 (YARD REGULATIONS), inclusive, or Section 33-30 (OTHER SPECIAL PROVISIONS FOR REAR YARDS), inclusive, provided that the height of such portion of a #building# shall not exceed two #stories#, excluding #basement#, nor in any event 30 feet above #curb level#. Any allowance for other permitted obstructions above a #building# in a #rear yard# or #rear yard equivalent# set forth in Section 33-23, shall be permitted above such modified height limitations.

**141-22  
Special Floor Area Regulations in R8A Districts**

\* \* \*

**141-23  
Special Height and Setback Regulations Along the Elevated Rail Structure Outside Subdistrict A**

\* \* \*

(c) Required and permitted articulation

\* \* \*

In addition, the underlying dormer provisions of paragraph (c) of Section ~~23-621~~ 23-623 shall be modified for portions of #buildings# facing the elevated rail structure, so that above the maximum base height set forth in paragraph (b) of this Section, dormers shall be permitted only within 75 feet of a corner.

**141-24  
Special Height and Setback Regulations in Subdistrict A**

\* \* \*

(c) Required and permitted articulation

\* \* \*

In addition, the underlying dormer provisions of paragraph (c) of Section ~~23-621~~ 23-623 shall apply, except that in Subareas A1 through A3, for #street walls# intersecting within 100 feet of the corners designated on Maps 2, 3 and 4, and irrespective of the width of the #street wall# below the maximum base height, dormers shall be permitted within 100 feet of such intersecting #street walls#. Such dormers need not decrease in width as the height above the maximum base height increases.

\* \* \*

**Chapter 2  
Special Inwood District**

\* \* \*

**142-40  
SPECIAL HEIGHT AND SETBACK REGULATIONS**

\* \* \*

**142-41  
Permitted Obstructions in Subareas A2, A3, B1, B3 and B4**

In Subareas A2, A3, B1, B3 and B4, as shown on Map 1 (Special Inwood District – Subdistricts and Subareas) in the Appendix to this Chapter, the provisions of Section 33-42 (Permitted Obstructions) shall apply to all #buildings#. In addition, along all #street# frontages, dormers may penetrate a maximum base height in accordance with the provisions of paragraph (c)(1) of Section ~~23-621~~ 23-623 (Permitted obstructions in certain districts), and balconies shall be permitted in conjunction with #residential uses# as set forth in Section 23-132 (Balconies in R6 through R10 Districts).

\* \* \*

**Chapter 3  
Special SoHo-NoHo Mixed Use District**

\* \* \*

**143-20  
SPECIAL BULK REGULATIONS**

\* \* \*

**143-23  
Special Yard Regulations**

The applicable #rear yard# and #rear yard equivalent# regulations shall be modified as follows:

(a) Permitted obstructions

In any #rear yard# or #rear yard equivalent#, any #building# or portion of a #building# used for #commercial#, #manufacturing#, or #residential uses#, other than dwelling units, shall be a permitted obstruction, provided that the height of such #building# shall not exceed one #story#, excluding #basement#, nor in any event 23 feet above #curb level#.

In addition, in M1-5 Districts paired with an R9X District north of Howard Street, in any #rear yard#, any #building# or portion of a #building# used for any permitted non-#residential use#, shall be a permitted obstruction, provided that the height of such #building#, or portion thereof, shall not exceed two #stories#, excluding #basements#, nor in any event 30 feet above #curb level#.

Any allowance for other permitted obstructions above a #building# in a #rear yard# or #rear yard equivalent# set forth in Section 43-23 Decks, parapet walls, roof thickness, skylights, vegetated roofs, and weirs, pursuant to Section 43-42 (Permitted obstructions), shall be permitted above such modified height limitations.

(b) Required #rear yards#

\* \* \*



**143-24  
Special Height and Setback Regulations**

For the purposes of this Section, Watts Street, West Broadway, Centre Street, and Great Jones Street shall be considered #wide streets#.

The applicable height and setback regulations are modified as follows:

\* \* \*

(d) Dormers

As an alternative to the dormer provisions of paragraph (c) of Section ~~23-621~~ 23-623, dormers may be a permitted obstruction within a required front setback distance above a maximum base height, provided that the aggregate width of all dormers at the maximum base height does not exceed 40 percent of the width of the #street wall# of the highest #story# entirely below the maximum base height. Such dormers need not decrease in width as the height above the maximum base height increases.

\* \* \*

RAFAEL SALAMANCA, Jr., *Chairperson*; CARLINA RIVERA, FARAH N. LOUIS, KEVIN C. RILEY, SELVENA N. BROOKS-POWERS, SHAUN ABREU, ERIK D. BOTTCHEER, SHEKAR KRISHNAN, DARLENE MEALY, PIERINA ANA SANCHEZ; 10-1-0; *Negative*: Joseph C. Borelli; *Absent*: Francisco P. Moya; *Conflict*: Kamillah Hanks; Committee on Land Use, November 20, 2023.

On motion of the Speaker (Council Member Adams), and adopted, the foregoing matter was coupled as a General Order for the day (see ROLL CALL ON GENERAL ORDERS FOR THE DAY).

## Report for L.U. No. 278 &amp; Res. No. 859

**Report of the Committee on Land Use in favor of approving, as modified, Application number C 220438 ZMK (Belmont Osborn Rezoning) submitted by Osborn Belmont Properties, LLC, pursuant to Sections 197-c and 201 of the New York City Charter for an amendment of the Zoning Map, Section No. 17d, eliminating from within an existing R6 District a C1-3 District, changing from an R6 District to an R7A District, changing from a C4-3 District to an R7A District, and establishing within the proposed R7A District a C2-4 District, Borough of Brooklyn, Community District 16, Council District 41.**

The Committee on Land Use, to which the annexed Land Use item was referred on October 5, 2023 (Minutes, page 2633) and which same Land Use item was coupled with the resolution shown below and referred to the City Planning Commission, respectfully

**REPORTS:****SUBJECT****BROOKLYN CB-16 – TWO APPLICATIONS RELATED TO BELMONT OSBORN REZONING****C 220438 ZMK (L.U. No. 278)**

City Planning Commission decision approving an application submitted by Osborn Belmont Properties, LLC, pursuant to Sections 197-c and 201 of the New York City Charter for an amendment of the Zoning Map, Section No. 17d:

1. eliminating from within an existing R6 District a C1-3 District bounded by a line midway between Pitkin Avenue and Belmont Avenue, Watkins Street, a line 100 feet northerly of Belmont Avenue, Osborne Street, Belmont Avenue, and Thatford Avenue;
2. changing from an R6 District to an R7A District property bounded by a line midway between Pitkin Avenue and Belmont Avenue, Watkins Street, a line 100 feet northerly of Belmont Avenue, Osborne Street, Belmont Avenue, and Thatford Avenue;
3. changing from a C4-3 District to an R7A District property bounded by a line 100 feet southerly of Pitkin Avenue, Watkins Street, a line midway between Pitkin Avenue and Belmont Avenue, and Osborne Street; and
4. establishing within the proposed R7A District a C2-4 District bounded by a line midway between Pitkin Avenue and Belmont Avenue, Osborne Street, a line 100 feet southerly of Pitkin Avenue, Watkins Street, a line 100 feet northerly of Belmont Avenue, Osborne Street, Belmont Avenue, and Thatford Avenue;

as shown on a diagram (for illustrative purposes only) dated April 24, 2023, and subject to the conditions of CEQR Declaration E-715.

**N 220439 ZRK (L.U. No. 279)**

City Planning Commission decision approving an application submitted by Osborn Belmont Properties LLC pursuant to Section 201 of the New York City Charter, for an amendment of the Zoning Resolution of the

City of New York, modifying APPENDIX F for the purpose of establishing a Mandatory Inclusionary Housing area, Borough of Brooklyn, Community District 16.

### **INTENT**

To approve the amendment to rezone the project area from an R6/C1-3 and C4-3 zoning districts to an R7A/C2-4 zoning district and amend the zoning text to designate the project area as a Mandatory Inclusionary Housing (MIH) area, to facilitate the development of two new mixed-use developments in the Brownsville neighborhood of Brooklyn.

### **PUBLIC HEARING**

**DATE:** October 17, 2023

**Witnesses in Favor:** Five

**Witnesses Against:** Two

### **SUBCOMMITTEE RECOMMENDATION**

**DATE:** November 20, 2023

The Subcommittee recommends that the Land Use Committee approve with modifications the decision of the City Planning Commission on L.U. No. 278 and approve with modifications the decision of the City Planning Commission on L.U. 279.

**In Favor:**

Riley  
Louis  
Abreu  
Bottcher  
Hanks  
Schulman  
Carr

**Against:**

None

**Abstain:**

None

### **COMMITTEE ACTION**

**DATE:** November 20, 2023

The Committee recommends that the Council approve the attached resolutions.

<b>In Favor:</b>	<b>Against:</b>	<b>Abstain:</b>
Salamanca	None	None
Rivera		
Louis		
Riley		
Abreu		
Brooks-Powers		
Bottcher		
Krishnan		
Mealy		
Sanchez		
Borelli		

### **FILING OF MODIFICATIONS WITH THE CITY PLANNING COMMISSION**

The City Planning Commission filed a letter dated [ *date* ], with the Council on [ *date* ], 2023, indicating that the proposed modifications are not subject to additional environmental review or additional review pursuant to Section 197-c of the City Charter.

In connection herewith, Council Members Salamanca and Riley offered the following resolution:

Res. No. 859

#### **Resolution approving with modifications the decision of the City Planning Commission on ULURP No. C 220438 ZMK, a Zoning Map amendment (L.U. No. 278).**

By Council Members Salamanca and Riley.

**WHEREAS**, Osborn Belmont Properties, LLC, filed an application pursuant to Sections 197-c and 201 of the New York City Charter for an amendment of the Zoning Map, Section No. 17d, by eliminating from within an existing R6 District a C1-3 District, changing from an R6 District to an R7A District, changing from a C4-3 District to an R7A District, and establishing within the proposed R7A District a C2-4 District, which in conjunction with the related action would facilitate the development of two, new seven-story developments, totaling approximately 210,000 square feet, with approximately 200 dwelling units and 34,000 square feet of retail space in Community District 16 (ULURP No. C 220438 ZMK) (the "Application");

**WHEREAS**, the City Planning Commission filed with the Council on October 2, 2023 its decision dated September 11, 2023 (the "Decision") on the Application;

**WHEREAS**, the Application is related to application N 220439 ZRK (L.U. No. 279), a zoning text amendment to designate a Mandatory Inclusionary Housing (MIH) area;

**WHEREAS**, the Decision is subject to review and action by the Council pursuant to Section 197-d of the City Charter;

**WHEREAS**, upon due notice, the Council held a public hearing on the Decision and Application on October 17, 2023;

**WHEREAS**, the Council has considered the land use and other policy issues relating to the Decision and Application; and

**WHEREAS**, the Council has considered the relevant environmental issues, including the Negative Declaration issued April 24<sup>th</sup>, 2023 (CEQR No. 22DCP009K), which includes an (E) designation to avoid the potential for significant adverse impacts related to hazardous materials, air quality, and noise (E-715) (the “Negative Declaration”).

**RESOLVED:**

The Council finds that the action described herein will have no significant impact on the environment as set forth in the (E) Designation (E-715) and Negative Declaration.

Pursuant to Sections 197-d and 200 of the City Charter and on the basis of the Decision and Application, and based on the environmental determination and consideration described in the report, C 220438 ZMK, incorporated by reference herein, and the record before the Council, the Council approves the Decision of the City Planning Commission, with the following modifications.

Matter ~~double struck out~~ is old, deleted by the City Council;

Matter double-underlined is new, added by the City Council

The Zoning Resolution of the City of New York, effective as of December 15, 1961, and as subsequently amended, is further amended by changing the Zoning Map, Section No. 17d:

1. eliminating from within an existing R6 District a C1-3 District bounded by a line midway between Pitkin Avenue and Belmont Avenue, Watkins Street, a line 100 feet northerly of Belmont Avenue, ~~Osborne Street, Belmont Avenue, and Thatford Avenue~~ Osborne Street;
2. changing from an R6 District to an R7A District property bounded by a line midway between Pitkin Avenue and Belmont Avenue, Watkins Street, a line 100 feet northerly of Belmont Avenue, ~~Osborne Street, Belmont Avenue, and Thatford Avenue~~ Osborne Street;
3. changing from a C4-3 District to an R7A District property bounded by a line 100 feet southerly of Pitkin Avenue, Watkins Street, a line midway between Pitkin Avenue and Belmont Avenue, and Osborne Street; and
4. establishing within the proposed R7A District a C2-4 District bounded by ~~a line midway between Pitkin Avenue and Belmont Avenue, Osborne Street,~~ a line 100 feet southerly of Pitkin Avenue, Watkins Street, a line 100 feet northerly of Belmont Avenue, ~~Osborne Street, Belmont Avenue, and Thatford Avenue~~ Osborne Street;

as shown on a diagram (for illustrative purposes only) dated April 24, 2023, and subject to the conditions of CEQR declaration E-715, Borough of Brooklyn, Community District 16.

RAFAEL SALAMANCA, Jr., *Chairperson*; CARLINA RIVERA, FARAH N. LOUIS, KEVIN C. RILEY, SELVENA N. BROOKS-POWERS, SHAUN ABREU, ERIK D. BOTTCHEER, SHEKAR KRISHNAN, DARLENE MEALY, PIERINA ANA SANCHEZ, JOSEPH C. BORELLI; 11-0-0; *Absent*: Francisco P. Moya; *Conflict*: Kamillah Hanks; Committee on Land Use, November 20, 2023.

On motion of the Speaker (Council Member Adams), and adopted, the foregoing matter was coupled as a General Order for the day (see ROLL CALL ON GENERAL ORDERS FOR THE DAY).

## Report for L.U. No. 279 &amp; Res. No. 860

**Report of the Committee on Land Use in favor of approving, as modified, Application number N 220439 ZRK (Belmont Osborn Rezoning) submitted by Osborn Belmont Properties, LLC, pursuant to Section 201 of the New York City Charter, for an amendment of the Zoning Resolution of the City of New York, modifying APPENDIX F for the purpose of establishing a Mandatory Inclusionary Housing area, Borough of Brooklyn, Community District 16, Council District 41.**

The Committee on Land Use, to which the annexed Land Use item was referred on October 5, 2023 (Minutes, page 2633) and which same Land Use item was coupled with the resolution shown below and referred to the City Planning Commission, respectfully

**REPORTS:**

**(For text of report, please see the Report of the Committee on Land Use for L.U. No. 278 & Res. No. 859 printed above in the General Orders Calendar section of these Minutes)**

*Accordingly, this Committee recommends its adoption, as modified.*

In connection herewith, Council Members Salamanca and Riley offered the following resolution:

Res. No. 860

**Resolution approving with modifications the decision of the City Planning Commission on Application No. N 220439 ZRK, for an amendment of the text of the Zoning Resolution (L.U. No. 279).**

By Council Members Salamanca and Riley.

**WHEREAS**, Osborn Belmont Properties, LLC, filed an application pursuant to Section 201 of the New York City Charter, for an amendment of the text of the Zoning Resolution of the City of New York, modifying APPENDIX F for the purpose of establishing a Mandatory Inclusionary Housing area, which in conjunction with the related action would facilitate the development of two new seven-story developments, totaling approximately 210,000 square feet, with approximately 200 dwelling units and 34,000 square feet of retail space in Community District 16 (ULURP No. N 220439 ZRK), (the "Application");

**WHEREAS**, the City Planning Commission filed with the Council on October 2, 2023, its decision dated September 11, 2023 (the "Decision") on the Application;

**WHEREAS**, the Application is related to application C 220438 ZMK (L.U. No. 278), a zoning map amendment to rezone part of an existing C4-3 district and an R6/C1-3 district to an R7A/C2-4 district;

**WHEREAS**, the Decision is subject to review and action by the Council pursuant to Section 197-d of the City Charter;

**WHEREAS**, upon due notice, the Council held a public hearing on the Decision and Application on October 17, 2023;

**WHEREAS**, the Council has considered the land use implications and other policy issues relating to the Decision and Application; and

**WHEREAS**, the Council has considered the relevant environmental issues, including the Negative Declaration issued April 24<sup>th</sup>, 2023 (CEQR No. 22DCP009K), which includes an (E) designation to avoid the potential for significant adverse impacts related to hazardous materials, air quality, and noise (E-715) (the "Negative Declaration").

**RESOLVED:**

The Council finds that the action described herein will have no significant impact on the environment as set forth in the (E) Designation (E-715) and Negative Declaration.

Pursuant to Sections 197-d and 200 of the City Charter and on the basis of the Decision and Application, and based on the environmental determination and consideration described in the report, N 220439 ZRK, incorporated by reference herein, and the record before the Council, the Council approves the Decision of the City Planning Commission, with the following modifications.

Matter underlined is new, to be added;

Matter ~~struck out~~ is to be deleted;

Matter within # # is defined in Section 12-10;

\* \* \* indicates where unchanged text appears in the Zoning Resolution.

Matter ~~double struck out~~ is old, deleted by the City Council;

Matter double-underlined is new, added by the City Council

\* \* \*

**APPENDIX F**

**Inclusionary Housing Designated Areas and Mandatory Inclusionary Housing Areas**

\* \* \*

**BROOKLYN**

\* \* \*

**Brooklyn Community District 16**

\* \* \*

Map 6 – [date of adoption]

[PROPOSED MAP]

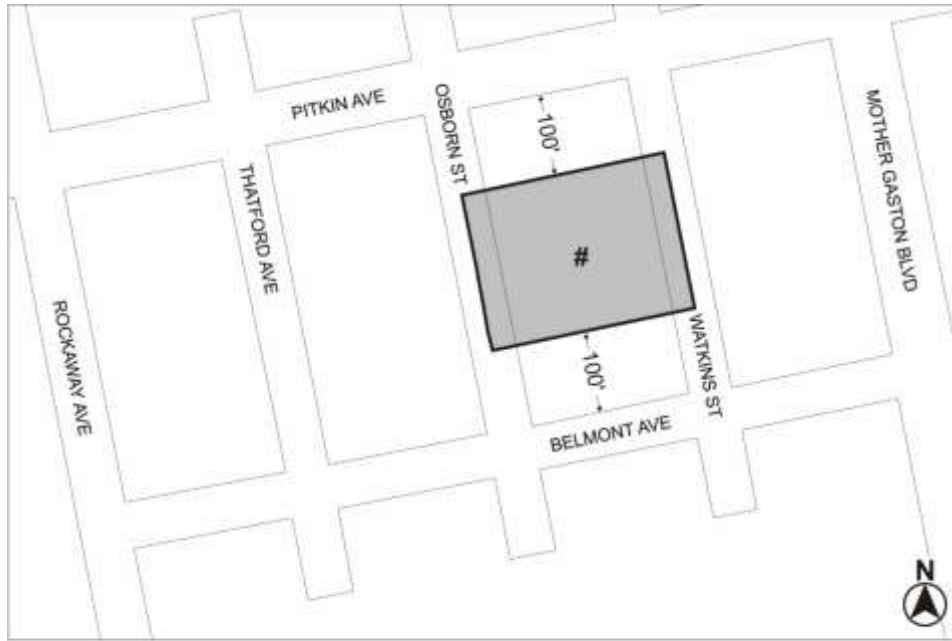

Mandatory Inclusionary Housing Program Area see Section 23-154(d)(3)  
 Area # — [date of adoption] MIH Program Option 1 and ~~Option 2~~ Deep Affordability Option

Portion of Community District 16, Brooklyn

\* \* \*

RAFAEL SALAMANCA, Jr., *Chairperson*; CARLINA RIVERA, FARAH N. LOUIS, KEVIN C. RILEY, SELVENA N. BROOKS-POWERS, SHAUN ABREU, ERIK D. BOTTCHEER, SHEKAR KRISHNAN, DARLENE MEALY, PIERINA ANA SANCHEZ, JOSEPH C. BORELLI; 11-0-0; *Absent*: Francisco P. Moya; *Conflict*: Kamillah Hanks; Committee on Land Use, November 20, 2023.

On motion of the Speaker (Council Member Adams), and adopted, the foregoing matter was coupled as a General Order for the day (see ROLL CALL ON GENERAL ORDERS FOR THE DAY).



Report for L.U. No. 284 & Res. No. 861

**Report of the Committee on Land Use in favor of approving, as modified, Application number C 230010 ZMK (534 Coney Island Avenue) submitted by Remica Property Group Corp., pursuant to Sections 197-c and 201 of the New York City Charter for the amendment of the Zoning Map, Section No. 22c, changing from a C8-2 District to an R7X District and establishing within the proposed R7X District a C2-4 District, Borough of Brooklyn, Community District 12, Council District 40.**

The Committee on Land Use, to which the annexed Land Use item was referred on October 19, 2023 (Minutes, page 2757) and which same Land Use item was coupled with the resolution shown below and referred to the City Planning Commission, respectfully

**REPORTS:**

**SUBJECT**

**BROOKLYN CB-12 – TWO APPLICATIONS RELATED TO 534 CONEY ISLAND AVENUE REZONING**

**C 230010 ZMK (L.U. No. 284)**

City Planning Commission decision approving an application submitted by Remica Property Group Corp., pursuant to Sections 197-c and 201 of the New York City Charter for the amendment of the Zoning Map, Section No. 22c:

1. changing from a C8-2 District to an R7X District property bounded by Hinckley Place, Coney Island Avenue, Beverly Road, a line 100 feet westerly of Coney Island Avenue; and
2. establishing within the proposed R7X District a C2-4 District bounded by Hinckley Place, Coney Island Avenue, Beverly Road, a line 100 feet westerly of Coney Island Avenue;

as shown on a diagram (for illustrative purposes only) dated May 22, 2023, and subject to the conditions of CEQR Declaration E-717.

**N 230011 ZRK (L.U. No. 285)**

City Planning Commission decision approving an application submitted by Remica Property Group Corp., pursuant to Section 201 of the New York City Charter, for an amendment of the Zoning Resolution of the City of New York, modifying APPENDIX F for the purpose of establishing a Mandatory Inclusionary Housing area.

**INTENT**

To approve the amendment to rezone the project area from an existing C8-2 zoning district to an R7X/C2-3 zoning district and amend the zoning text to designate the project area as a Mandatory Inclusionary Housing (MIH) area, to facilitate the development of a new, mixed-use residential development at 534 Coney Island Avenue in the Kensington neighborhood of Brooklyn, Community District 12.

**PUBLIC HEARING****DATE:** October 17, 2023**Witnesses in Favor:** Six**Witnesses Against:** None**SUBCOMMITTEE RECOMMENDATION****DATE:** November 20, 2023

The Subcommittee recommends that the Land Use Committee approve the decision of the City Planning Commission on L.U. No. 284 and approve with modifications the decision of the City Planning Commission on L.U. No. 285.

**In Favor:**

Riley  
Louis  
Abreu  
Bottcher  
Hanks  
Schulman  
Carr

**Against:**

None

**Abstain:**

None

**COMMITTEE ACTION****DATE:** November 20, 2023

The Committee recommends that the Council approve the attached resolutions.

**In Favor:**

Salamanca  
Rivera  
Louis  
Riley  
Abreu  
Brooks-Powers  
Bottcher  
Krishnan  
Mealy  
Sanchez  
Borelli

**Against:**

None

**Abstain:**

None

**FILING OF MODIFICATIONS WITH THE CITY PLANNING COMMISSION**

The City Planning Commission filed a letter dated [ *date* ], with the Council on [ *date* ], 2023, indicating that the proposed modifications are not subject to additional environmental review or additional review pursuant to Section 197-c of the City Charter.

In connection herewith, Council Members Salamanca and Riley offered the following resolution:

Res. No. 861

**Resolution approving the decision of the City Planning Commission on ULURP No. C 230010 ZMK, a Zoning Map amendment (L.U. No. 284).**

By Council Members Salamanca and Riley.

**WHEREAS**, Remica Property Group Corp., filed an application pursuant to Sections 197-c and 201 of the New York City Charter for an amendment of the Zoning Map, Section No. 22c, by changing from a C8-2 District to an R7X District and establishing within the proposed R7X District a C2-4 District, which in conjunction with the related action would facilitate the development of a new mixed-use development at 534 Coney Island Avenue, in the Kensington neighborhood of Brooklyn, Community District 12 (ULURP No. C 230010 ZMK) (the “Application”);

**WHEREAS**, the City Planning Commission filed with the Council on October 6, 2023 its decision dated October 2, 2023 (the “Decision”) on the Application;

**WHEREAS**, the Application is related to application N 230011 ZRK (L.U. No. 285), a zoning text amendment to designate a Mandatory Inclusionary Housing (MIH) area;

**WHEREAS**, the Decision is subject to review and action by the Council pursuant to Section 197-d of the City Charter;

**WHEREAS**, upon due notice, the Council held a public hearing on the Decision and Application on October 17, 2023;

**WHEREAS**, the Council has considered the land use and other policy issues relating to the Decision and Application; and

**WHEREAS**, the Council has considered the relevant environmental issues, including the Negative Declaration issued May 22<sup>nd</sup>, 2023 (CEQR No. 23DCP033K), which includes an (E) designation to avoid the potential for significant adverse impacts related to hazardous materials, air quality, and noise (E-717) (the “Negative Declaration”).

**RESOLVED:**

The Council finds that the action described herein will have no significant impact on the environment as set forth in the (E) Designation (E-717) and Negative Declaration.

Pursuant to Sections 197-d and 200 of the City Charter and on the basis of the Decision and Application, and based on the environmental determination and consideration described in the report, C 230010 ZMK, incorporated by reference herein, and the record before the Council, the Council approves the Decision of the City Planning Commission.

The Zoning Resolution of the City of New York, effective as of December 15, 1961, and as subsequently amended, is further amended by changing the Zoning Map, Section No. 22c:

1. changing from a C8-2 District to an R7X District property bounded by Hinckley Place, Coney Island Avenue, Beverly Road, a line 100 feet westerly of Coney Island Avenue; and
2. establishing within the proposed R7X District a C2-4 District bounded by Hinckley Place, Coney Island Avenue, Beverly Road, a line 100 feet westerly of Coney Island Avenue;

as shown on a diagram (for illustrative purposes only) dated May 22, 2023, and subject to the conditions of CEQR Declaration E-717, Borough of Brooklyn, Community District 12.

RAFAEL SALAMANCA, Jr., *Chairperson*; CARLINA RIVERA, FARAH N. LOUIS, KEVIN C. RILEY, SELVENA N. BROOKS-POWERS, SHAUN ABREU, ERIK D. BOTTCHER, SHEKAR KRISHNAN, DARLENE MEALY, PIERINA ANA SANCHEZ, JOSEPH C. BORELLI; 11-0-0; *Absent*: Francisco P. Moya; *Conflict*: Kamillah Hanks; Committee on Land Use, November 20, 2023.

On motion of the Speaker (Council Member Adams), and adopted, the foregoing matter was coupled as a General Order for the day (see ROLL CALL ON GENERAL ORDERS FOR THE DAY).

Report for L.U. No. 285 & Res. No. 862

**Report of the Committee on Land Use in favor of approving, as modified, Application number N 230011 ZRK (534 Coney Island Avenue) submitted by Remica Property Group Corp., pursuant to Section 201 of the New York City Charter, for an amendment of the Zoning Resolution of the City of New York, modifying APPENDIX F for the purpose of establishing a Mandatory Inclusionary Housing area, Borough of Brooklyn, Community District 12, Council District 40.**

The Committee on Land Use, to which the annexed Land Use item was referred on October 19, 2023 (Minutes, page 2757) and which same Land Use item was coupled with the resolution shown below and referred to the City Planning Commission, respectfully

#### REPORTS:

**(For text of report, please see the Report of the Committee on Land Use for L.U. No. 284 & Res. No. 861 printed above in the General Orders Calendar section of these Minutes)**

*Accordingly, this Committee recommends its adoption, as modified.*

In connection herewith, Council Members Salamanca and Riley offered the following resolution:

Res. No. 862

**Resolution approving with modifications the decision of the City Planning Commission on Application No. N 230011 ZRK, for an amendment of the text of the Zoning Resolution (L.U. No. 285).**

By Council Members Salamanca and Riley.

**WHEREAS**, Remica Property Group Corp., filed an application pursuant to Section 201 of the New York City Charter, for an amendment of the text of the Zoning Resolution of the City of New York, modifying APPENDIX F for the purpose of establishing a Mandatory Inclusionary Housing area, which in conjunction with

the related action would facilitate the construction of a new mixed-use development at 534 Coney Island Avenue, in the Kensington neighborhood of Brooklyn, Community District 12 (ULURP No. N 230011 ZRK), (the “Application”);

**WHEREAS**, the City Planning Commission filed with the Council on October 6, 2023, its decision dated October 2, 2023 (the “Decision”) on the Application;

**WHEREAS**, the Application is related to application C 230010 ZMK (L.U. No. 284), a zoning map amendment to change an C8-2 zoning district to an R7X district along with a C2-4 commercial overlay;

**WHEREAS**, the Decision is subject to review and action by the Council pursuant to Section 197-d of the City Charter;

**WHEREAS**, upon due notice, the Council held a public hearing on the Decision and Application on October 17, 2023;

**WHEREAS**, the Council has considered the land use implications and other policy issues relating to the Decision and Application; and

**WHEREAS**, the Council has considered the relevant environmental issues, including the Negative Declaration issued May 22<sup>nd</sup>, 2023 (CEQR No. 23DCP033K), which includes an (E) designation to avoid the potential for significant adverse impacts related to hazardous materials, air quality, and noise (E-717) (the “Negative Declaration”).

**RESOLVED:**

The Council finds that the action described herein will have no significant impact on the environment as set forth in the (E) Designation (E-717) and Negative Declaration.

Pursuant to Sections 197-d and 200 of the City Charter and on the basis of the Decision and Application, and based on the environmental determination and consideration described in the report, N 230011 ZRK, incorporated by reference herein, and the record before the Council, the Council approves the Decision of the City Planning Commission, with the following modifications.

Matter underlined is new, to be added;

Matter ~~struck out~~ is to be deleted;

Matter within # # is defined in Section 12-10;

\* \* \* indicates where unchanged text appears in the Zoning Resolution.

Matter ~~double struck out~~ is old, deleted by the City Council;

Matter double-underlined is new, added by the City Council

\* \* \*

**APPENDIX F**

**Inclusionary Housing Designated Areas and Mandatory Inclusionary Housing Areas**

\* \* \*

**BROOKLYN**

\* \* \*

**Brooklyn Community District 12**

\* \* \*

Map 5 – [date of adoption]



Portion of Community District 12, Brooklyn

\* \* \*

RAFAEL SALAMANCA, Jr., *Chairperson*; CARLINA RIVERA, FARAH N. LOUIS, KEVIN C. RILEY, SELVENA N. BROOKS-POWERS, SHAUN ABREU, ERIK D. BOTTCHEER, SHEKAR KRISHNAN, DARLENE MEALY, PIERINA ANA SANCHEZ, JOSEPH C. BORELLI; 11-0-0; *Absent*: Francisco P. Moya; *Conflict*: Kamillah Hanks; Committee on Land Use, November 20, 2023.

On motion of the Speaker (Council Member Adams), and adopted, the foregoing matter was coupled as a General Order for the day (see ROLL CALL ON GENERAL ORDERS FOR THE DAY).

**Resolution approving various persons Commissioners of Deeds**

By the Presiding Officer –

Resolved, that the following named persons be and hereby are appointed Commissioners of Deeds for a term of two years:

*Approved New Applicants*

<i>Name</i>	<i>Address</i>	<i>District #</i>
ARIANA THOMAS	121 Madison Ave, Apt 12A New York, New York 10016	1
LIANNE MAY	102 Mott Street, Apt 4D New York, New York 10013	1
JULIA NORALES	830 Amsterdam Ave, Apt 5C New York, New York 10025	7
DISLEYSI GARCIA	485 Jackson Ave, Apt 6 Bronx, New York 10455	8
TREVOR HACKETT	100 Cabrini Blvd, Apt 36 New York, New York 10033	10
CONNIE VILLON	846 Quincy Ave Bronx, New York 10465	13
ANTHONY MARK ROWTIE	1554 Unionport Road, ME Bronx, New York 10462	18
NICHOLAS KUCZEK	2354 31st Ave, Apt 3 Queens, New York 11106	22
CARLA RAMOUTAR	142-20 84th Drive Queens, New York 11435	24
JASMINE THOMAS-PETIT	71-54 163rd Street, Apt 3 Queens, New York 11365	24
SARA ASSELMAN	45-20 41st Street, 1 Floor Queens, New York 11104	26
CARTER GARFIELD	142 Montague Street, Apt 5F Brooklyn, New York 11201	33
MARCUS SESSOMS	851 Dekalb Ave, Apt 4L Brooklyn, New York 11221	36

DAISY PEREZ	197 Covert Street, A Brooklyn, New York 11207	37
KINESHA JONES	902 Drew Street, Apt 410 Brooklyn, New York 11208	42
KARINA CORONA	2125 West 5th Street, 2nd Floor Brooklyn, New York 11223	47
EVERETT WATTLEY	200 Trantor Place, Apt 2D Staten Island, New York 10302	49
ERICA GUASH	196 Woodbine Ave Staten Island, New York 10314	50
JENNIFER PAGANO	604 Ionia Ave Staten Island, New York 10312	51

On motion of the Speaker (Council Member Adams), and adopted, the foregoing matter was coupled as a General Order for the day (see ROLL CALL ON GENERAL ORDERS FOR THE DAY).



**ROLL CALL ON GENERAL ORDERS FOR THE DAY**  
**(Items Coupled on General Orders Calendar)**

- (1) **Int. No. 195-B -** Inspection of unoccupied dwelling units.
- (2) **Int. No. 198-A -** Department of Education to stock opioid antagonists in all school buildings.
- (3) **Int. No. 417-B -** Transportation projects.
- (4) **Int. No. 774-A -** Department of Environmental Protection to measure construction-related sound levels inside dwelling units upon request and prohibited noise levels for sound attributable to construction devices.
- (5) **Int. No. 775-A -** Noise inspections.
- (6) **Int. No. 776-A -** Providing noise inspection reports.
- (7) **Int. No. 778-A -** Photo noise violation monitoring device program for motor vehicles.
- (8) **Int. No. 1055-A -** Menstrual products.
- (9) **Int. No. 1056-A -** Provision of menstrual products in schools.
- (10) **Int. No. 1057-A -** Department of Correction to report on the distribution of menstrual products in city correctional facilities.
- (11) **Int. No. 1058-A -** Educational materials on menstrual products.
- (12) **Int. No. 1059-A -** Menstrual cups in the definition of menstrual products and the provision of such products.
- (13) **Int. No. 1101-A -** Anti-racism training for human services contractors.
- (14) **Int. No. 1118-A -** Anti-racism and anti-racial discrimination trainings for employees, interns, independent contractors, and volunteers of city agencies.

- (15) **Int. No. 1184-A -** Commissioner of Cultural Affairs to report annually on department funding of art and cultural organizations and institutions.
- (16) **Int. No. 1194-A -** Compensation awarded by the Environmental Control Board to complainants for citizen noise complaints and to the maximum penalty authorized for violations.
- (17) **L.U. No. 277 & Res. No. 858 -** **App. N 230113 ZRY (City of Yes for Carbon Neutrality)** Modifying multiple Sections to remove impediments to, and expand opportunities for, decarbonization projects within all zoning districts, Citywide.
- (18) **L.U. No. 278 & Res. No. 859 -** **App. C 220438 ZMK (Belmont Osborn Rezoning)** Borough of Brooklyn, Community District 16, Council District 41.
- (19) **L.U. No. 279 & Res. No. 860 -** **Application number N 220439 ZRK (Belmont Osborn Rezoning)** Brooklyn, Community District 16, Council District 41.
- (20) **L.U. No. 284 & Res. No. 861 -** **App. C 230010 ZMK (534 Coney Island Avenue)** Brooklyn, Community District 12, Council District 40.
- (21) **L.U. No. 285 & Res No. 862 -** **App. N 230011 ZRK (534 Coney Island Avenue)** Brooklyn, Community District 12, Council District 40.
- (22) **Preconsidered L.U. No. 288 & Res. No. 854 -** 1601 DeKalb, Brooklyn, Community District 4, Council District No. 37.
- (23) **Preconsidered L.U. No. 289 & Res. No. 855 -** Sumet I, Brooklyn, Community District 1, Council District No. 34.
- (24) **Preconsidered L.U. No. 290 & Res. No. 856 -** MHANY Stella Heights LLC.PLP.FY24, Manhattan, Community District 12, Council Districts No. 7 and 10.

(25) **Preconsidered** Villa Hermosa, Manhattan,  
**L.U. No. 291 &** Community District 11, Council  
**Res. No. 857 -** District No. 9.

(26) **Resolution approving various persons Commissioners of Deeds.**

The Majority Leader and Acting President Pro Tempore (Council Member Powers) put the question whether the Council would agree with and adopt such reports which were decided in the **affirmative** by the following vote:

**Affirmative** – Abreu, Ariola, Avilés, Ayala, Barron, Bottcher, Brannan, Brewer, Brooks-Powers, Cabán, Carr, De La Rosa, Dinowitz, Farías, Feliz, Gennaro, Gutiérrez, Hanif, Hanks, Holden, Hudson, Joseph, Kagan, Krishnan, Louis, Menin, Moya, Narcisse, Nurse, Ossé, Paladino, Restler, Richardson Jordan, Riley, Rivera, Salamanca, Sanchez, Schulman, Stevens, Ung, Vernikov, Williams, Won, Yeger, the Minority Leader (Council Member Borelli), the Majority Leader (Council Member Powers) and the Speaker (Council Member Adams) - **47**.

*Present, Not Voting* – Marte.

**The General Order vote recorded for this Stated Meeting was 47-0-0 (with one Council Member considered Present, Not Voting) as shown above with the exception of the votes for the following legislative items:**

The following was the vote recorded for **Int. No. 195-B:**

**Affirmative** – Abreu, Avilés, Ayala, Barron, Bottcher, Brannan, Brewer, Brooks-Powers, Cabán, De La Rosa, Dinowitz, Farías, Feliz, Gennaro, Gutiérrez, Hanif, Hanks, Hudson, Joseph, Krishnan, Louis, Menin, Moya, Narcisse, Nurse, Ossé, Restler, Richardson Jordan, Riley, Rivera, Salamanca, Sanchez, Schulman, Stevens, Ung, Williams, Won, the Majority Leader (Council Member Powers) and the Speaker (Council Member Adams) - **39**.

**Negative** – Ariola, Carr, Holden, Kagan, Paladino, Vernikov, Yeger, and the Minority Leader (Council Member Borelli) - **8**.

*Present, Not Voting* – Marte.

The following was the vote recorded for **Int. No. 417-B:**

**Affirmative** – Abreu, Avilés, Ayala, Bottcher, Brannan, Brewer, Brooks-Powers, Cabán, De La Rosa, Farías, Feliz, Gennaro, Gutiérrez, Hanif, Hudson, Joseph, Krishnan, Menin, Moya, Nurse, Ossé, Restler, Richardson Jordan, Riley, Rivera, Sanchez, Schulman, Stevens, Williams, Won, the Majority Leader (Council Member Powers) and the Speaker (Council Member Adams) - **32**.

**Negative** – Ariola, Barron, Carr, Dinowitz, Hanks, Holden, Kagan, Louis, Narcisse, Paladino, Salamanca, Ung, Vernikov, Yeger, and the Minority Leader (Council Member Borelli) - **15**.

*Present, Not Voting* – Marte.

The following was the vote recorded for **Int. No. 778-A**:

**Affirmative** – Abreu, Ariola, Ayala, Barron, Bottcher, Brannan, Brewer, Brooks-Powers, Cabán, Carr, De La Rosa, Dinowitz, Farías, Feliz, Gennaro, Gutiérrez, Hanif, Hanks, Holden, Hudson, Joseph, Kagan, Krishnan, Louis, Menin, Moya, Narcisse, Nurse, Ossé, Paladino, Restler, Richardson Jordan, Riley, Rivera, Salamanca, Sanchez, Schulman, Stevens, Ung, Vernikov, Williams, Won, Yeger, the Minority Leader (Council Member Borelli), the Majority Leader (Council Member Powers) and the Speaker (Council Member Adams) - **46**.

**Negative** – Avilés – **1**.

*Present, Not Voting* – Marte.

The following was the vote recorded for **Int. No. 1055-A**:

**Affirmative** – Abreu, Avilés, Ayala, Barron, Bottcher, Brannan, Brewer, Brooks-Powers, Cabán, De La Rosa, Dinowitz, Farías, Feliz, Gennaro, Gutiérrez, Hanif, Hanks, Holden, Hudson, Joseph, Kagan, Krishnan, Louis, Menin, Moya, Narcisse, Nurse, Ossé, Restler, Richardson Jordan, Riley, Rivera, Salamanca, Sanchez, Schulman, Stevens, Ung, Williams, Won, Yeger, the Minority Leader (Council Member Borelli), the Majority Leader (Council Member Powers) and the Speaker (Council Member Adams) - **43**.

**Negative** – Ariola, Carr, Paladino, and Vernikov – **4**.

*Present, Not Voting* – Marte.

The following was the vote recorded for **Int. No. 1101-A and Int. No. 1118-A**:

**Affirmative** – Abreu, Avilés, Ayala, Barron, Bottcher, Brannan, Brewer, Brooks-Powers, Cabán, De La Rosa, Dinowitz, Farías, Feliz, Gennaro, Gutiérrez, Hanif, Hanks, Holden, Hudson, Joseph, Krishnan, Louis, Menin, Moya, Narcisse, Nurse, Ossé, Restler, Richardson Jordan, Riley, Rivera, Salamanca, Sanchez, Schulman, Stevens, Ung, Williams, Won, the Majority Leader (Council Member Powers) and the Speaker (Council Member Adams) - **40**.

**Negative** – Ariola, Carr, Kagan, Paladino, Vernikov, Yeger, and the Minority Leader (Council Member Borelli) - **7**.

*Present, Not Voting* – Marte.

The following was the vote recorded for **Int. No. 1194-A**:

**Affirmative** – Abreu, Ariola, Ayala, Brannan, Brewer, Brooks-Powers, Cabán, Carr, De La Rosa, Dinowitz, Farías, Feliz, Gennaro, Gutiérrez, Hanif, Hanks, Holden, Joseph, Kagan, Krishnan, Louis, Menin, Moya, Narcisse, Nurse, Ossé, Paladino, Restler, Richardson Jordan, Riley, Rivera, Salamanca, Sanchez, Schulman, Stevens, Ung, Vernikov, Williams, Won, Yeger, the Minority Leader (Council Member Borelli), the Majority Leader (Council Member Powers) and the Speaker (Council Member Adams) - **43**.

**Negative** – Aviles, Barron, and Bottcher – **3**.

**Abstention** – Hudson – **1**.

*Present, Not Voting* – Marte.

The following was the vote recorded for **L.U. No. 277 & Res. No. 858**:

**Affirmative** – Abreu, Avilés, Ayala, Bottcher, Brannan, Brewer, Brooks-Powers, Cabán, De La Rosa, Dinowitz, Farías, Feliz, Gennaro, Gutiérrez, Hanif, Hanks, Hudson, Joseph, Krishnan, Louis, Menin, Moya, Narcisse, Nurse, Ossé, Restler, Richardson Jordan, Riley, Rivera, Salamanca, Sanchez, Schulman, Stevens, Ung, Williams, Won, the Majority Leader (Council Member Powers) and the Speaker (Council Member Adams) - **38**.

**Negative** – Ariola, Carr, Holden, Kagan, Paladino, Vernikov, Yeger, and the Minority Leader (Council Member Borelli) – **8**.

**Abstention** – Barron – **1**.

*Present, Not Voting* – Marte.

The following was the vote recorded for **L.U. No. 284 & Res. No. 861 and L.U. No. 285 & Res. No. 862**:

**Affirmative** – Abreu, Ariola, Avilés, Ayala, Bottcher, Brannan, Brewer, Brooks-Powers, Cabán, Carr, De La Rosa, Dinowitz, Farías, Feliz, Gennaro, Gutiérrez, Hanif, Hanks, Holden, Hudson, Joseph, Kagan, Krishnan, Louis, Menin, Moya, Narcisse, Nurse, Ossé, Paladino, Restler, Richardson Jordan, Riley, Rivera, Salamanca, Sanchez, Schulman, Stevens, Ung, Vernikov, Williams, Won, Yeger, the Minority Leader (Council Member Borelli), the Majority Leader (Council Member Powers) and the Speaker (Council Member Adams) - **46**.

**Negative** – Barron – **1**.

*Present, Not Voting* – Marte.

*The following Introductions were sent to the Mayor for his consideration and approval:*

*Int. Nos. 195-B, 198-A, 417-B, 774-A, 775-A, 776-A, 778-A, 1055-A, 1056-A, 1057-A, 1058-A, 1059-A, 1101-A, 1118-A, 1184-A, and 1194-A.*

## RESOLUTIONS

*Presented for voice-vote on the Resolutions Calendar*

**The following are the respective Committee Reports for each of the Resolutions referred to the Council for a voice-vote pursuant to Rule 8.50 of the Council:**

Report for voice-vote item Res. No. 165-A

**Report of the Committee on Women and Gender Equity in favor of approving, as amended, a Resolution calling on the State Legislature to pass, and the Governor to sign, A.2583/S.15, authorizing certain shelters for victims of domestic violence to be reimbursed for any payment differential for housing a single individual in a room intended for double occupancy.**

The Committee on Committee on Women and Gender Equity, to which the annexed amended resolution was referred on May 19, 2023 (Minutes, page 1104), respectfully

### REPORTS:

**(For text of report, please see the Report of the Committee on Women and Gender Equity for Int. No. 1055-A printed in the Reports of the Standing Committees section of these Minutes)**

*Accordingly, this Committee recommends its adoption, as amended.*

**(The following is the text of Res. No. 165-A:)**

Res. No. 165-A

**Resolution calling on the State Legislature to pass, and the Governor to sign, A.2583/S.15, authorizing certain shelters for victims of domestic violence to be reimbursed for any payment differential for housing a single individual in a room intended for double occupancy.**

By Council Members Louis, Yeger, Hudson, Ung, Nurse, Abreu, Sanchez, Rivera, Hanif, Gennaro and the Public Advocate (Mr. Williams).

**Whereas**, Domestic violence, sometimes known as intimate partner violence or relationship abuse, is usually defined as a pattern of abusive behavior in a relationship used by one partner to maintain or gain power and control over another partner; and

**Whereas**, Domestic violence is a leading cause of homelessness in New York City, in addition to evictions and overcrowding; and

**Whereas**, Domestic violence survivors often cannot stay with family members for fear of running into their abusers, and many lack the income to find permanent housing quickly; and

**Whereas**, The provision of safe emergency shelter is a primary tool for those fleeing domestic violence; and

**Whereas**, The domestic violence emergency shelter system was originally created to provide short-term respite for victims of domestic violence and their families who were fleeing imminent danger; and

**Whereas**, Within New York City, domestic violence shelters were created over several decades to house families rather than single adults; and

**Whereas**, New York City Human Resources Administration's domestic violence shelters served an average of 122 single adults per month in the first half of 2019; and

**Whereas**, Non-profit providers who operate these shelters are reimbursed by the New York State Office of Children and Family Services per person per night; and

**Whereas**, The reimbursement from the State is intended to cover the entire cost of operating domestic violence shelters, including rent, utilities, staffing, and services; and

**Whereas**, Any reduction in this reimbursement severely impacts the ability of the provider to cover the cost of operating the shelter; and

**Whereas**, The State reimbursement formula discourages domestic violence emergency shelter providers from placing a smaller family or single adult in a large apartment or room; and

**Whereas**, Single adult victims of domestic violence have a harder time accessing domestic violence shelters; and

**Whereas**, A.2583, sponsored by Assembly Member Andrew D. Hevesi, and S.15, sponsored by Senator Andrew Gounardes, would require the State to preserve the full reimbursement to providers who accommodate a single adult in a room configured for a family of two; and

**Whereas**, This legislation would help increase system-wide capacity for single adults who otherwise face serious obstacles to accessing the domestic violence shelter system; and

**Whereas**, If enacted, A.2583/S.15 would ensure that providers are not penalized for accommodating a single adult fleeing a dangerous situation; now, therefore, be it

**Resolved**, That the Council of the City of New York calls on the State Legislature to pass, and the Governor to sign, A.2583/S.15, authorizing certain shelters for victims of domestic violence to be reimbursed for any payment differential for housing a single individual in a room intended for double occupancy.

TIFFANY CABÁN, *Chairperson*; KEVIN C. RILEY, JENNIFER GUTIÉRREZ, KRISTIN RICHARDSON JORDAN, INNA VERNIKOV; 5-0-0; *Absent*: James F. Gennaro and Althea V. Stevens; Committee on Women and Gender Equity, December 6, 2023.

Pursuant to Rule 8.50 of the Council, the Majority Leader and Acting President Pro Tempore (Council Member Powers) called for a voice vote. Hearing no objections, the Majority Leader and Acting President Pro Tempore (Council Member Powers) declared the Resolution to be adopted.

Adopted unanimously by the Council by voice-vote.

Report for voice-vote item Res. No. 345-B

**Report of the Committee on Housing and Buildings in favor of approving, as amended, a Resolution calling upon the New York State Legislature to pass, and the Governor to sign, A.1493/S.2721, in relation to establishing a New York state office of civil representation to provide access to legal services in eviction proceedings.**

The Committee on Committee on Housing and Buildings, to which the annexed amended resolution was referred on October 12, 2022 (Minutes, page 2491), respectfully

#### **REPORTS:**

**(For text of report, please see the Report of the Committee on Housing and Buildings for Int. No. 195-B printed in the Reports of the Standing Committees section of these Minutes)**

*Accordingly, this Committee recommends its adoption, as amended.*

**(The following is the text of Res. No. 345-B:)**

## Res. No. 345-B

**Resolution calling upon the New York State Legislature to pass, and the Governor to sign, A.1493/S.2721, in relation to establishing a New York state office of civil representation to provide access to legal services in eviction proceedings.**

By Council Members Sanchez, Stevens, Restler, Joseph, Williams, Abreu, Barron, Hudson, Nurse, Brewer, Riley, Cabán, Avilés, Powers, Won, Gutiérrez, Farías, Ossé, Hanif, De La Rosa, Krishnan, Schulman, Bottcher, Richardson Jordan, Rivera, Narcisse, Marte and Louis.

**Whereas**, The New York City Right to Counsel law was passed by the City Council and went into effect in 2017 and it has been effective in keeping tenants in their homes; and

**Whereas**, The Community Service Society, a charitable organization, stated that only 1 percent of tenants were previously represented with an attorney in housing court, but when the law was implemented 74 percent of the tenants facing eviction had an attorney; and

**Whereas**, In New York City, the Right to Counsel (RTC) law does not cover everyone, excluding, for example, households who are above 200 percent of the federal poverty line and public housing residents; and

**Whereas**, Tenants throughout the rest of the state do not have a right to counsel; and

**Whereas**, Research from the Right to Counsel NYC Coalition, a tenant advocacy group, documented that there were 142,806 eviction cases pending in New York State on March 15, 2020, at the start of the COVID-19 pandemic, and as of February 26, 2023 there were over 276,668 active eviction cases; and

**Whereas**, Providing legal assistance to households who are at risk of housing instability not only adds a layer of protection but it saves public funds that could otherwise be spent on shelters or services for people who are experiencing homelessness; and

**Whereas**, According to the Right to Counsel NYC Coalition, courts are moving eviction cases at a pace that results in thousands of New York City tenants who are otherwise eligible for the RTC program being denied; and

**Whereas**, A.1493, introduced by Assembly Member Latoya Joyner and pending in the New York State Assembly, and companion bill S.2721, introduced by State Senator Rachel May and pending in the New York State Senate would create a New York State office of civil representation that would provide the right to free and full representation to all New Yorkers in all cases that might result in their displacement; and

**Whereas**, A.1493/S.2721 would also be a solution to the local court crisis since it would require the court system to mandate adjournments until a tenant has been able to secure an attorney and it could help pace cases to attorney capacity; now, therefore, be it

**Resolved**, That the Council of the City of New York calls on the New York State Legislature to pass, and the Governor to sign, A.1493/S.2721, in relation to establishing a New York state office of civil representation to provide access to legal services in eviction proceedings.

PIERINA ANA SANCHEZ, *Chairperson*; ERIC DINOWITZ, OSWALD FELIZ, TIFFANY CABÁN, SHAUN ABREU, ALEXA AVILÉS, CHARLES BARRON, CRYSTAL HUDSON; 8-1-0; *Negative*: David M. Carr; Committee on Housing and Buildings, December 6, 2023.

Pursuant to Rule 8.50 of the Council, the Majority Leader and Acting President Pro Tempore (Council Member Powers) called for a voice vote. Hearing those in favor, the Majority Leader and Acting President Pro Tempore (Council Member Powers) declared the Resolution to be adopted.

The following 8 Council Members formally noted their intention to vote in the **negative** against this item:

Council Members Ariola, Carr, Holden, Kagan, Paladino, Vernikov, Yeger, and the Minority Leader (Council Member Borelli).

Adopted by the Council by voice-vote.



Report for voice-vote item Res. No. 499-B

**Report of the Committee on Housing and Buildings in favor of approving, as amended, a Resolution calling on the New York State legislature to pass, and the Governor to sign, A.4993/S.3254, requiring that any party eligible under local law for free legal counsel for an eviction proceeding may be granted an adjournment by the court for additional time to secure counsel.**

The Committee on Committee on Housing and Buildings, to which the annexed amended resolution was referred on February 16, 2023 (Minutes, page 549), respectfully

**REPORTS:**

**(For text of report, please see the Report of the Committee on Housing and Buildings for Int. No. 195-B printed in the Reports of the Standing Committees section of these Minutes)**

*Accordingly, this Committee recommends its adoption, as amended.*

**(The following is the text of Res. No. 499-B:)**

Res. No. 499-B

**Resolution calling on the New York State legislature to pass, and the Governor to sign, A.4993/S.3254, requiring that any party eligible under local law for free legal counsel for an eviction proceeding may be granted an adjournment by the court for additional time to secure counsel.**

By Council Members Abreu, Restler, Hudson, Richardson Jordan, Ayala, Marte, Joseph, Riley, Krishnan, Barron, Avilés, Won, Farías, Nurse, Cabán, Powers, Gutiérrez, Brewer, Ossé, Hanif, De La Rosa, Sanchez, Bottcher, Louis, Rivera, Schulman, Narcisse (in conjunction with the Bronx Borough President).

**Whereas**, In 2017, New York City (NYC) was the first city in the nation to pass a law guaranteeing free legal services to all tenants facing eviction proceedings in housing court, also known as the Right to Counsel law, which mandated the provision of free legal representation for those making at or below 200% of the Federal Poverty Guidelines; and

**Whereas**, The NYC Council passed an expansion of the law in the summer of 2020, amidst the height of the COVID-19 pandemic, to cover all 5 boroughs immediately; and

**Whereas**, The Right to Counsel law has achieved measureable effects, as the NYC Office of Civil Justice found that over the past four years, 84% of tenants who received representation under Right to Counsel won their cases and stayed in their homes, and since its pandemic-related expansion, the Right to Counsel law saw 71% of tenants in housing court with full legal representation compared with a pre-pandemic rate of 38%, and a markedly better rate than the 1% of tenants with full legal representation in 2013; and

**Whereas**, According to the Community Service Society, the Right to Counsel law has led to an approximately 30% decrease in eviction filings since its 2017 origins; and

**Whereas**, The COVID-19 pandemic saw the temporary implementation of eviction moratoriums in an effort to keep New Yorkers in their homes during an unprecedented public health emergency and consequent economic crisis that saw billions in lost revenue and wages; and

**Whereas**, Despite improved economic indicators in 2022, NYC's economy still has not fully recovered, as many New Yorkers are still experiencing the impact of at least two years of lost income, and according to sources like the NYC Comptroller and New York State Comptroller, NYC's economic recovery is still lagging behind national averages while the economy attempts to reach pre-pandemic levels of activity; and

**Whereas**, NYC's Independent Budget Office forecasted the City's workforce to not return to pre-pandemic levels until 2025; and

**Whereas**, The New York State eviction moratoriums expired in January 2022, allowing eviction cases to resume in housing courts across the City while New Yorkers are facing an estimated \$3.3 billion in back rent; and

**Whereas**, Eviction cases resuming in the City have led to housing court calendars inundated with eviction cases as courthouses face 2 years of eviction case backlogs along with additional new filings, with around 200,000 eviction cases filed before and during the pandemic, 6,382 cases filed in February 2022, and 7,740 cases filed in March 2022, per data from the New York State Office of Court Administration; and

**Whereas**, Legal service providers contracted with the City to provide Right to Counsel services, The Legal Aid Society of NYC, Legal Services NYC, and New York Legal Aid Group, released a joint statement on April 5, 2022, detailing the need for a slowdown in scheduling court cases, as factors such as the backlog of pending eviction cases, lack of staff, the prep time needed for each case, and clustered case scheduling means there would be an insufficient number of attorneys and those in need will not have their lawfully provided legal representation in housing court; and

**Whereas**, The contracted legal service providers have been declining hundreds of cases per month due to a lack of resources, for example, Legal Services NYC had to decline more than 475 cases in the Bronx in March of 2022; and

**Whereas**, From March to May 2022, Office of Court Administration data shared with New York Daily News revealed that approximately 2,500 defendants otherwise eligible for Right to Counsel representation were forced to go to housing court without any legal representation due to the insufficient number of lawyers to keep up with the number of cases scheduled in the housing docket; and

**Whereas**, Eviction places New Yorkers into incredibly unstable environments, contributing to increases in homelessness while also straining the City's already overburdened shelter system;

**Whereas**, A.4993, sponsored by State Assembly Member Linda B. Rosenthal, and companion bill S.3254, sponsored by State Senator Brad Hoylman-Sigal, would require courts to adjourn eviction proceedings to provide parties to that eviction proceeding with adequate opportunity to secure counsel in jurisdictions like NYC where access to counsel is guaranteed under the law; now, therefore, be it

**Resolved**, That the Council of the City of New York calls on the New York State legislature to pass, and the Governor to sign, A.4993/S.3254, requiring that any party eligible under local law for free legal counsel for an eviction proceeding may be granted an adjournment by the court for additional time to secure counsel.

PIERINA ANA SANCHEZ, *Chairperson*; ERIC DINOWITZ, OSWALD FELIZ, TIFFANY CABÁN, SHAUN ABREU, ALEXA AVILÉS, CHARLES BARRON, CRYSTAL HUDSON; 8-1-0; *Negative*: David M. Carr; Committee on Housing and Buildings, December 6, 2023.

Pursuant to Rule 8.50 of the Council, the Majority Leader and Acting President Pro Tempore (Council Member Powers) called for a voice vote. Hearing those in favor, the Majority Leader and Acting President Pro Tempore (Council Member Powers) declared the Resolution to be adopted.

The following 8 Council Members formally noted their intention to vote in the **negative** against this item:

Council Members Ariola, Carr, Holden, Kagan, Paladino, Vernikov, Yeger, and the Minority Leader (Council Member Borelli)

Adopted by the Council by voice-vote.

Report for voice-vote item Res. No. 534-A

**Report of the Committee on Education in favor of approving, as amended, a Resolution calling on the New York State Legislature to pass, and the New York State Governor to sign, A.3723/S.759 and A.816/S.879, which would extend the hours of use for student MetroCards in New York City and would prohibit the Metropolitan Transportation Authority from promulgating rules or regulations that penalize a student for using a student MetroCard when school is not in session.**

The Committee on Committee on Education, to which the annexed amended resolution was referred on March 16, 2023 (Minutes, page 857), respectfully

**REPORTS:**

**(For text of report, please see the Report of the Committee on Education for Int. No. 198-A printed in the Reports of the Standing Committees section of these Minutes)**

*Accordingly, this Committee recommends its adoption, as amended.*

**(The following is the text of Res. No. 534-A:)**

Res. No. 534-A

**Resolution calling on the New York State Legislature to pass, and the New York State Governor to sign, A.3723/S.759 and A.816/S.879, which would extend the hours of use for student MetroCards in New York City and would prohibit the Metropolitan Transportation Authority from promulgating rules or regulations that penalize a student for using a student MetroCard when school is not in session.**

By Council Members Joseph, Louis, Schulman, Hudson, Ung, Ayala, Brewer, Lee, Riley, Stevens, Rivera, Cabán, Menin, Hanks, Nurse, Avilés, Ossé, Gennaro, Brooks-Powers, Dinowitz and Narcisse.

**Whereas**, The Metropolitan Transportation Authority (MTA), largely in collaboration with the New York City Department of Education (DOE), distributes student MetroCards to eligible students at the beginning of each semester, and as needed during the school year; and

**Whereas**, Student MetroCards provide three free rides via MTA subways and/or buses each school day, between 5:30 a.m. and 8:30 p.m., and include a free transfer between buses, or between the subway and local, limited or Select bus service; and

**Whereas**, A student MetroCard is only to be used by the student to whom it was assigned, is only permitted to be used during the specified times, and even then is only permitted to be used when the student's school is open for classes; and

**Whereas**, Students that are eligible for student MetroCards include those that are in grades K through 12, who live more than .5 miles from their school, and who do not have yellow school bus service available; and

**Whereas**, In addition, some students at private and parochial schools have access to student MetroCards; and

**Whereas**, About one million students of New York City's public, private and parochial schools utilize student MetroCards; and

**Whereas**, Student MetroCards provide an important service to New York City students, allowing them to move from home to school, and then to school-related activities, for free; and

**Whereas**, Although helpful, students and families have expressed concerns that the student MetroCard program does not currently serve them in the most effective way possible, expressing that the current time restraints placed on student MetroCards limits opportunities for students to engage in afterschool activities; and

**Whereas**, According to a May 2020 "Student MetroCard Policy Report" by Assemblymember Harvey Epstein's 74<sup>th</sup> District Youth Council and in partnership with the Coalition for Student Transit Justice, in a survey of 881 New York City students, 73.2% of those surveyed responded that they take part in afterschool activities

that require public transit after 8:30 p.m., the current cut-off time after which a student MetroCard cannot be utilized; and

**Whereas**, In addition, students who utilize their student MetroCard on a day when school is not in session may be fined \$100, have their MetroCard revoked, or face additional penalties under current New York City Transit Authority rules and regulations; and

**Whereas**, A.3723, introduced by New York State Assemblymember Harvey Epstein, and S.759, introduced by New York State Senator John C. Liu, would establish a student fare program that would provide three free fares each weekday between 5:00 a.m. and 10:00 p.m., effectively expanding the time window during which students would be allowed to utilize their student MetroCard; and

**Whereas**, A.816, introduced by New York State Assemblymember Epstein, and S.879, introduced by New York State Senator Liu, would prohibit the MTA from promulgating any rules or regulations that penalize a student for using their student MetroCard on a non-school day; and

**Whereas**, As New York City students deserve to be able to have cost-free transportation to and from home, school and school-related activities at times that they truly need it, while also not being penalized harshly by utilizing their student MetroCard during times when they still need to get to and from home and school activities despite school otherwise being closed for the day, A.3723/S.759 and A.816/S.879 should be adopted; now, therefore, be it

**Resolved**, That the Council of the City of New York calls upon the New York State Legislature to pass, and the New York State Governor to sign, A.3723/S.759 and A.816/S.879, which would extend the hours of use for student MetroCards in New York City and would prohibit the Metropolitan Transportation Authority from promulgating rules or regulations that penalize a student for using a student MetroCard when school is not in session.

RITA C. JOSEPH, *Chairperson*; FARAH N. LOUIS, JAMES F. GENNARO, ERIC DINOWITZ, OSWALD FELIZ, ALEXA AVILÉS, CARMEN N. De La ROSA, SHAHANA K. HANIF, SHEKAR KRISHNAN, LINDA LEE, JULIE MENIN, MERCEDES NARCISSE, LINCOLN RESTLER, PIERINA ANA SANCHEZ, LYNN C. SCHULMAN, SANDRA UNG.; 16-0-0; *Absent*: Jennifer Gutiérrez; Kamillah Hanks, and Althea V. Stevens; Committee on Education, December 5, 2023.

Pursuant to Rule 8.50 of the Council, the Majority Leader and Acting President Pro Tempore (Council Member Powers) called for a voice vote. Hearing no objections, the Majority Leader and Acting President Pro Tempore (Council Member Powers) declared the Resolution to be adopted.

Adopted unanimously by the Council by voice-vote.

Report for voice-vote item Res. No. 547

**Report of the Committee on Civil Service and Labor in favor of approving a Resolution calling upon the New York City School Construction Authority (SCA) and the New York City Department of Design and Construction (DDC) to reconsider their decision to substitute precast concrete wall panels in place of traditional handset brick and block walls in public projects in New York City.**

The Committee on Committee on Civil Service and Labor, to which the annexed resolution was referred on April 11, 2023 (Minutes, page 959), respectfully

**REPORTS:**

## I. INTRODUCTION

On December 6, 2023, the Committee on Civil Service and Labor, chaired by Council Member Carmen De La Rosa, will vote on Resolution Number 547-2023 (Res. 547), calling upon the New York City School Construction Authority and the New York City Department of Design and Construction to reconsider their decision to substitute precast concrete wall panels in place of traditional handset brick and block walls in public projects in New York City. On May 31, 2023, the Committee held a hearing on this resolution and received testimony from the Department of Citywide Administrative Services (DCAS), municipal labor unions, and advocates, including the Bricklayers & Allied Craftworkers Local Union No. 1, Mason Tenders District Council, the New York State Concrete Masonry Association, and other interested members of the public.

*Accordingly, this Committee recommends its adoption.*

**(The following is the text of Res. No. 547:)**

Res. No. 547

**Resolution calling upon the New York City School Construction Authority (SCA) and the New York City Department of Design and Construction (DDC) to reconsider their decision to substitute precast concrete wall panels in place of traditional handset brick and block walls in public projects in New York City.**

By Council Members De La Rosa, Ung, Krishnan, Gennaro, Farías, Won, Brewer, Powers, Narcisse, Ossé, Bottcher, Abreu, Holden, Schulman, Marte, Moya, Hudson, Brannan, Ayala, Riley, Hanks, Menin, Hanif, Dinowitz, Avilés, Rivera, Nurse and Louis.

**Whereas**, The New York City School Construction Authority (SCA) is the central authority governing the construction and renovation of schools in New York City; and

**Whereas**, New York City's Department of Design and Construction (DDC), meanwhile, acts as the principal project manager on the City's capital construction projects; and

**Whereas**, As such, design guidelines and building preferences adopted by both the SCA and DDC have a marked impact on the construction industry, particularly in New York State (NYS); and

**Whereas**, Over the past few years, the SCA has issued design guidelines that prefer using precast concrete wall panels (PCPs) instead of traditional handset brick and block, in its construction process; and

**Whereas**, Similarly, DDC has several major projects currently in process where PCPs are being utilized; and

**Whereas**, The preference for using PCPs over handset brick and block has a number of negative economic, environmental and equity impacts on New York City (NYC); and

**Whereas**, In 2022, Governor Kathy Hochul signed the Low Embodied Carbon Concrete Leadership Act (LECCLA) which calls for low-embodied carbon concrete to be used in NYS public projects and for agencies and boards appointed pursuant to NYS Law to develop guidelines for procuring low-embodied carbon concrete; and

**Whereas**, In 2022, Mayor Eric Adams issued two Executive Orders (EOs) #22 and #23, wherein the former directs all NYC agencies to tailor opportunities to support employment of city residents and to support diversity in hiring and the latter directs all NYC agencies to incorporate low-carbon solutions in order to reduce CO2 emissions in construction; and

**Whereas**, The City Council fully supports the policies of the LECCLA, EO#22 and EO#23 and asks both the SCA and the DDC to adhere to all three; and

**Whereas**, A 2022 study on the economic impacts of handset brick and block walls versus PCPs used in the construction of NYC schools concluded that, for every \$1 million expenditure on handset brick and block walls, an additional \$1.25 million is generated in the local NYC economy over and above a \$1 million expenditure on PCPs; and

**Whereas**, Furthermore, this same report from Pinnacle Economics found that using handset brick and block instead of PCPs increased working hours for most local trades workers and manufacturing workers and that 68 percent of those hours benefited minority workers in NYC; and

**Whereas**, Of the top ten PCP manufacturers in the United States, there are none in New York but there are multiple block manufacturers in NYS including one block manufacturer New York City; and

**Whereas**, An analysis from the 2022 comparative report from Pinnacle Economics shows that “block/brick walls represent 10.9 percent of total project costs and are locally produced in NYC while precast concrete panels represent 74.8 percent of total project costs and are imported”; and

**Whereas**, According to the Concrete Masonry Association of California and Nevada, using handset brick and block over PCPs benefits the environment by reducing the amount of cement required in the construction of a wall, thus reducing CO2 emissions in construction; and

**Whereas**, Local manufacturers of concrete masonry blocks use local recycled material in the forms of processed glass collected from the NYC waste stream and the carbon capture system as featured in a March 10, 2023 *New York Times* article, which further reduces the CO2 impact of the locally sourced concrete masonry blocks, the out-of-state PCP manufacturers do not; and

**Whereas**, Given that all of the largest PCP manufacturers are outside of New York, the decision to use PCPs has a negative environmental impact because the material has to be transported into NYS and, further, has a negative economic impact because PCPs support out-of-state businesses to the detriment of NYS citizens and businesses; and

**Whereas**, While PCPs may expedite the construction process, the 2021 data collected by RSMeans Data from the Gordian Group shows that, nationally, PCPs cost nearly 36 percent more per square foot for material and installation than handset brick and block walls; and

**Whereas**, The replacement of handset brick and block laying with PCPs places local manufacturing along with the brick and block-laying trades at risk; and

**Whereas**, According to data from the United States Bureau of Labor Statistics, NYS had the highest employment level of brickmasons, blockmasons and mason tenders in the country; and

**Whereas**, As a City with a diverse structural landscape, NYC relies heavily on these trades and manufacturing workers to build, repair, maintain, and fabricate construction materials for its new and historical building stock; now, therefore, be it

**Resolved**, That the Council of the City of New York calls on the SCA and the DDC to reconsider their decisions to substitute PCPs in place of traditional, handset brick and block walls in public projects in NYC.

CARMEN N. De La ROSA, *Chairperson*; ERIK D. BOTTCHER, TIFFANY CABÁN, ERIC DINOWITZ, OSWALD FELIZ, KAMILLAH HANKS, RITA C. JOSEPH, JULIE MENIN, FRANCISCO P. MOYA, SANDY NURSE; 10-0-0, Committee on Civil Service and Labor, December 6, 2023.

Pursuant to Rule 8.50 of the Council, the Majority Leader and Acting President Pro Tempore (Council Member Powers) called for a voice vote. Hearing no objections, the Majority Leader and Acting President Pro Tempore (Council Member Powers) declared the Resolution to be adopted.

Adopted unanimously by the Council by voice-vote.

Report for voice-vote item Res. No. 568

**Report of the Committee on Cultural Affairs, Libraries and International Intergroup Relations in favor of approving a Resolution designating May 10 annually as National Pan-Hellenic Council Day in the City of New York to recognize the contributions made to social change by members of nine Black sororities and fraternities, known as the Divine Nine.**

The Committee on Committee on Cultural Affairs, Libraries and International Intergroup Relations, to which the annexed resolution was referred on April 11, 2023 (Minutes, page 1003), respectfully

**REPORTS:**

(For text of report, please see the Report of the Committee on Cultural Affairs, Libraries and International Intergroup Relations for Int. No. 1184-A printed in the Reports of the Standing Committees section of these Minutes)

*Accordingly, this Committee recommends its adoption.*

**(The following is the text of Res. No. 568:)**

Res. No. 568

**Resolution designating May 10 annually as National Pan-Hellenic Council Day in the City of New York to recognize the contributions made to social change by members of nine Black sororities and fraternities, known as the Divine Nine.**

By Council Members Williams, Riley, Farías, Brooks-Powers, Rivera and Gennaro.

**Whereas**, The National Pan-Hellenic Council (NPHC) is the coordinating body of Black Greek-Letter Organizations of college-educated women and men committed to “community awareness and action through educational, economic, and cultural service activities”; and

**Whereas**, NPHC was founded on May 10, 1930, at Howard University by five chartering organizations—Alpha Kappa Alpha Sorority, Delta Sigma Theta Sorority, Zeta Phi Beta Sorority, Kappa Alpha Psi Fraternity, and Omega Psi Phi Fraternity; and

**Whereas**, NPHC then added four more organizations to its membership—Alpha Phi Alpha Fraternity and Phi Beta Sigma Fraternity in 1931, Sigma Gamma Rho Sorority in 1937, and Iota Phi Theta Fraternity in 1997—later becoming known affectionately as the “Divine Nine”; and

**Whereas**, Each NPHC sorority and fraternity grew out of a time when Blacks were denied fundamental rights and when Black college students too often felt isolated by their race or social class on college campuses; and

**Whereas**, NPHC’s powerful motto “Until We Are All Free” made its purpose clear; and

**Whereas**, NPHC sororities and fraternities began to work together to create social programs that would bring about the social change that their members wanted to see for themselves, for their peers, for Blacks across the nation, and for the nation itself; and

**Whereas**, NPHC expects that, after graduation, members of its nine sororities and fraternities will join a graduate chapter and continue to be active in community work dedicated to positive social change wherever they live; and

**Whereas**, NPHC currently oversees 97 collegiate councils and 172 alumnae/alumni councils (including one for Greater New York) across 40 states and in other countries; and

**Whereas**, Members of NPHC sororities and fraternities have made significant contributions to the advancement of civil rights, including W.E.B. DuBois, Jesse Jackson, Al Sharpton, and Martin Luther King, Jr.; and

**Whereas**, Members of NPHC sororities and fraternities have made significant contributions in performing arts, including Ben Vereen, Ava DuVernay, Sheryl Lee Ralph, Wanda Sykes, and Phylicia Rashad; and

**Whereas**, Members of NPHC sororities and fraternities have made significant contributions in literature, including Langston Hughes, Zora Neale Hurston, and Nikki Giovanni; and

**Whereas**, Members of NPHC sororities and fraternities have made significant contributions in government service, including Thurgood Marshall, Andrew Young, and Vice President Kamala Harris; and

**Whereas**, In speaking to a convention of her Alpha Kappa Alpha sorors in July 2022, Vice President Harris, a proud Howard University graduate, noted that the Divine Nine were “founded to create lasting bonds of community” and that all of the founders “were acutely aware we needed to build networks of support for young Black men and women who attend college in America”; and

**Whereas**, Vice President Harris, recalling a photograph of President Harry S. Truman from 1950, remarked that President Truman “was meeting with representatives from the National Pan-Hellenic Council, which included a member of our sorority, to talk about ending employment discrimination in America” and that “members of the Divine Nine have always made sure Black voices are in the rooms where decisions are being made...and [that] we will always fight for what our communities need and for the best of who we are as a nation”; and

**Whereas**, Vice President Harris concluded her remarks by noting that “through our sisterhood, we teach that there is no barrier we cannot break and there is no obstacle we cannot overcome”; and

**Whereas**, Today, members of the Divine Nine continue a legacy of breaking barriers and overcoming obstacles in the service of social change; and

**Whereas**, Members of the Divine Nine in federal government service from New York City (NYC) include Brooklynites Shirley Chisholm, the first Black woman elected to the United States House of Representatives (1969-1983), and Hakeem Jeffries, the first Black Minority Leader of the House of Representatives; and

**Whereas**, Members of the Divine Nine in local government service in NYC include Adrienne Adams, the first Black woman elected as the Speaker of the New York City Council, as well as other current and former Council members; and

**Whereas**, The designation of a day is fitting to commemorate the founding of the NPHC and the community work that is done by Divine Nine members in NYC and in communities across the nation; now, therefore, be it

**Resolved**, That the Council of the City of New York designates May 10 annually as National Pan-Hellenic Council Day in the City of New York to recognize the contributions made to social change by members of nine Black sororities and fraternities, known as the Divine Nine.

CHI A. OSSÉ, *Chairperson*; FRANCISCO P. MOYA, FARAH N. LOUIS, ERIC DINOWITZ, AMANDA FARÍAS, SHAHANA K. HANIF, CRYSTAL HUSDON, RITA C. JOSEPH; 8-0-0, *Medical*: Sandra Ung; Committee on Cultural Affairs, Libraries and International Intergroup Relations, December 6, 2023.

Pursuant to Rule 8.50 of the Council, the Majority Leader and Acting President Pro Tempore (Council Member Powers) called for a voice vote. Hearing no objections, the Majority Leader and Acting President Pro Tempore (Council Member Powers) declared the Resolution to be adopted.

Adopted unanimously by the Council by voice-vote.

Report for voice-vote item Res. No. 579

**Report of the Committee on Education in favor of approving a Resolution calling on the New York City Department of Education to ensure that the New York State Seal of Biliteracy is awarded in all New York City public high schools to eligible students.**



The Committee on Committee on Education, to which the annexed resolution was referred on April 27, 2023 (Minutes, page 1135), respectfully

**REPORTS:**

**(For text of report, please see the Report of the Committee on Education for Int. No. 198-A printed in the Reports of the Standing Committees section of these Minutes)**

*Accordingly, this Committee recommends its adoption.*

**(The following is the text of Res. No. 579:)**

Res. No. 579

**Resolution calling on the New York City Department of Education to ensure that the New York State Seal of Biliiteracy is awarded in all New York City public high schools to eligible students.**

By Council Members Dinowitz, Louis, Hanif, Hudson, Riley, Lee, Rivera, Cabán, Gennaro, Brewer, Joseph and Narcisse.

**Whereas**, According to the Endangered Language Alliance, over 700 languages and dialects are spoken in New York City (NYC) and the nearby metropolitan area, with 38 percent of those languages from Asia, 24 percent from Africa, 19 percent from Europe, 16 percent from the Americas, and the remaining from Oceania and the Pacific; and

**Whereas**, Building trust and understanding across the many language and cultural groups in NYC’s diverse communities often calls for multilingual communication skills; and

**Whereas**, Multilingual communication skills are also a critical element in enabling NYC to participate effectively in a global political, social, and economic context; and

**Whereas**, Mastery of two or more world languages also makes an important contribution to students’ cognitive development, understanding of diverse cultures, and preparation for future college study and career opportunities in NYC and worldwide; and

**Whereas**, Students who have significant skills in two or more world languages, including students whose first language is not English and students whose skills are in underrepresented languages, should be recognized and rewarded academically; and

**Whereas**, According to a study by the American Council on the Teaching of Foreign Languages, credentialing bilingualism more broadly than what is available now has the potential to level some of the inequities that exist between commonly taught and less commonly taught languages; and

**Whereas**, The New York State Education Department (NYSED) states that the New York State Seal of Biliiteracy (NYSSB), established by the New York State Legislature in 2012, “recognizes high school graduates who have attained a high level of proficiency in the three modes of communication (Interpretive, Interpersonal, Presentational) in English and one or more world languages”; and

**Whereas**, The NYSSB affirms the value of diversity, honors the multiple cultures and languages of New York communities, and supports the importance of underrepresented languages, while it furthers college and career success for high school graduates; and

**Whereas**, A 2013 University of California at Los Angeles survey of California employers found that 66 percent of employers “would prefer a bilingual employee over a monolingual English speaker if they were comparable in other respects,” while from 67 to 92 percent of employers, depending on the field of employment, felt that holders of the California State Seal of Biliiteracy would “have an advantage in hiring”; and

**Whereas**, The NYSSB does not limit the languages for which the Seal can be awarded, thus making it possible to support students from underrepresented communities, including indigenous communities, whose language proficiency cannot be demonstrated through commercially available standardized tests; and

**Whereas**, In 2021-2022, 62 NYC Department of Education (NYCDOE) schools offered the NYSSB, with 25 percent of the high schools in Staten Island, 21 percent of those in Queens, 10 percent of those in Brooklyn, 10 percent of those in the Bronx, and 7 percent of those in Manhattan offering the credential; and

**Whereas**, In 2021-2022, 1,043 students graduating from NYCDOE high schools earned the NYSSB in 31 different languages—Albanian, Arabic, Azerbaijani, Bambara, Bangla, Bosnian, Burmese, Dutch, French, Fulani, German, Greek, Haitian Creole, Hebrew, Igbo, Italian, Japanese, Korean, Krio, Latin, Mandarin, Mandinka, Polish, Punjabi, Romanian, Russian, Soninke, Spanish, Tagalog, Urdu, and Yoruba; and

**Whereas**, In 2021-2022, of the 1,043 students graduating from NYCDOE high schools and earning the NYSSB, 400 were from Queens, 294 from Brooklyn, 184 from the Bronx, 140 from Manhattan, and 25 from Staten Island; and

**Whereas**, Many colleges provide only a few ways for students to earn foreign language credits based on prior learning, such as by scoring well on a College Board Advanced Placement (AP) Exam, which costs students as much as \$97 and is offered in just seven world languages; and

**Whereas**, The NYSSB provides an additional way for incoming freshmen to earn foreign language credits in any world language and is free to NYCDOE high school students, with testing and other costs borne by the NYCDOE and the NYSED; and

**Whereas**, The NYSSB provides both colleges and employers with an established and credible credential to use in identifying and rewarding high school graduates with biliteracy skills; now, therefore, be it

**Resolved**, That the Council of the City of New York calls on the New York City Department of Education to ensure that the New York State Seal of Biliteracy is awarded in all New York City public high schools to eligible students.

RITA C. JOSEPH, *Chairperson*; FARAH N. LOUIS, JAMES F. GENNARO, ERIC DINOWITZ, OSWALD FELIZ, ALEXA AVILÉS, CARMEN N. De La ROSA, SHAHANA K. HANIF, SHEKAR KRISHNAN, LINDA LEE, JULIE MENIN, MERCEDES NARCISSE, LINCOLN RESTLER, PIERINA ANA SANCHEZ, LYNN C. SCHULMAN, SANDRA UNG,; 16-0-0; *Absent*: Jennifer Gutiérrez; Kamillah Hanks, and Althea V. Stevens; Committee on Education, December 5, 2023.

Pursuant to Rule 8.50 of the Council, the Majority Leader and Acting President Pro Tempore (Council Member Powers) called for a voice vote. Hearing no objections, the Majority Leader and Acting President Pro Tempore (Council Member Powers) declared the Resolution to be adopted.

Adopted unanimously by the Council by voice-vote.

Report for voice-vote item Res. No. 580

**Report of the Committee on Higher Education in favor of approving a Resolution calling on The City University of New York to ensure that all campuses award an appropriate number of college credits to students who earned a New York State Seal of Biliteracy in high school and, where required, accept that Seal as fulfillment of any foreign language requirement.**

The Committee on Committee on Higher Education, to which the annexed resolution was referred on April 27, 2023 (Minutes, page 1136), respectfully

#### **REPORTS:**

On Wednesday, December 6, 2023, the Committee on Higher Education, chaired by Council Member Eric Dinowitz, will hold a vote on Resolution Number (Res. No.) 580, sponsored by Council Member Dinowitz,

calling on The City University of New York to ensure that all campuses award an appropriate number of college credits to students who earned a New York State Seal of Biliteracy in high school and, where required, accept that Seal as fulfillment of any foreign language requirement. The Committee originally heard this legislation, with public testimony, on October 18, 2023.

*Accordingly, this Committee recommends its adoption.*

**(The following is the text of Res. No. 580:)**

Res. No. 580

**Resolution calling on The City University of New York to ensure that all campuses award an appropriate number of college credits to students who earned a New York State Seal of Biliteracy in high school and, where required, accept that Seal as fulfillment of any foreign language requirement.**

By Council Members Dinowitz, Louis, Hanif, Hudson, Brewer, Riley, Lee, Cabán and Narcisse.

**Whereas**, According to the Endangered Language Alliance, over 700 languages and dialects are spoken in New York City (NYC) and the nearby metropolitan area, with 38 percent of those languages from Asia, 24 percent from Africa, 19 percent from Europe, 16 percent from the Americas, and the remaining from Oceania and the Pacific; and

**Whereas**, About 40 percent of undergraduates at The City University of New York (CUNY) speak a language other than English, with 174 different languages spoken across CUNY’s campuses; and

**Whereas**, With proper credentialing, incoming CUNY students who have mastered two or more world languages, including students whose first language is not English, should be recognized and rewarded academically for their language skills; and

**Whereas**, The New York State Education Department (NYSED) states that the New York State Seal of Biliteracy (NYSSB), established by the New York State Legislature in 2012, “recognizes high school graduates who have attained a high level of proficiency in the three modes of communication (Interpretive, Interpersonal, Presentational) in English and one or more world languages”; and

**Whereas**, The NYSSB affirms the value of diversity, honors the multiple cultures and languages of New York communities, and supports the importance of underrepresented languages, while it furthers college and career success for high school graduates; and

**Whereas**, The NYSSB does not limit the languages for which the Seal can be awarded, thus making it possible to support students from underrepresented communities, including indigenous communities, whose language proficiency cannot be demonstrated through commercially available standardized tests; and

**Whereas**, In 2021-2022, 1,043 students graduating from NYC Department of Education (DOE) high schools across the five boroughs earned the NYSSB in 31 different languages; and

**Whereas**, CUNY, which enrolls about 45 percent of NYCDOE graduates (according to 2018-2019 figures), offers very limited ways for students to earn foreign language credits based on prior learning, such as by scoring a 3 on a College Board Advanced Placement (AP) Exam, offered in just seven world languages; and

**Whereas**, Public universities in other states and cities offer credit for the Seal of Biliteracy in their states, such as Illinois, where the Illinois School Code states that “[e]ach public community college and public university in this State shall establish criteria to translate a State Seal of Biliteracy into course credit based on foreign language course equivalencies identified by the community college’s or university’s faculty and staff”; and

**Whereas**, At the City Colleges of Chicago (CCC), the Illinois State Seal of Biliteracy is worth 4 semester hours of foreign language credit if it is in a language taught at CCC or 4 semester hours of humanities elective credit if it is in a language not taught; and

**Whereas**, Depending on individual college policies, students with a Massachusetts State Seal of Biliteracy may earn from 4 to 15 college credits either in foreign languages or in humanities or fine arts electives in at least nine public higher education institutions; and

**Whereas**, Depending on individual college policies, students attending Minnesota's public higher education system of 30 colleges and seven universities may be awarded from two semesters to four semesters worth of college foreign language credits for earning the Minnesota Bilingual and Multilingual Seals; and

**Whereas**, Many more CUNY students who earned the NYSSB at a NYCDOE high school could potentially meet CUNY's academic requirements quicker if CUNY campuses awarded foreign language credits and an exemption from any foreign language requirement, based on a student's earning the NYSSB; now, therefore, be it

**Resolved**, That the Council of the City of New York calls on The City University of New York to ensure that all campuses award an appropriate number of college credits to students who earned a New York State Seal of Biliteracy in high school and, where required, accept that Seal as fulfillment of any foreign language requirement.

ERIC DINOWITZ, *Chairperson*; OSWALD FELIZ, CHARLES BARRON, GALE A. BREWER, INNA VERNIKOV; 5-0-0; Committee on Higher Education, December 6, 2023.

Pursuant to Rule 8.50 of the Council, the Majority Leader and Acting President Pro Tempore (Council Member Powers) called for a voice vote. Hearing no objections, the Majority Leader and Acting President Pro Tempore (Council Member Powers) declared the Resolution to be adopted.

Adopted unanimously by the Council by voice-vote.

Report for voice-vote Res. No. 742

**Report of the Committee on Education in favor of approving a Resolution calling on the New York City Department of Education to develop curriculum on machine learning, and adapt their current curriculum and policies to account for the safe use of generative AI.**

The Committee on Committee on Education, to which the annexed resolution was referred on September 14, 2023 (Minutes, page 2563), respectfully

**REPORTS:**

**(For text of report, please see the Report of the Committee on Education for Int. No. 198-A printed in the Reports of the Standing Committees section of these Minutes)**

*Accordingly, this Committee recommends its adoption.*

**(The following is the text of Res. No. 742:)**

Res. No. 742

**Resolution calling on the New York City Department of Education to develop curriculum on machine learning, and adapt their current curriculum and policies to account for the safe use of generative AI.**

By Council Members Abreu, Joseph, Gutiérrez, Farías, Ossé, Krishnan, Hanif, De La Rosa, Riley, Williams, Ung, Bottcher, Rivera, Schulman, Louis, Menin, Nurse, Hudson, Brewer and Narcisse (by request of the Manhattan Borough President).

**Whereas**, Generative artificial intelligence (AI) is a type of AI that can generate new content, including text, images and videos, through learning patterns from pre-existing data; and

**Whereas**, Examples of generative AI systems include image generators, large language models, code generation tools, or audio generation tools; and

**Whereas**, Since the public release of Open AI's ChatGPT, a chatbot powered by an underlying large language model trained to follow an instruction in a prompt and provide a detailed response in a humanlike conversational dialogue within seconds, it has become the fastest-growing consumer application in history, growing from one million users following its launch in November 2022 to over 100 million users in January 2023; and

**Whereas**, In addition to text outputs, generative AI can be used to analyze large data sets, identify trends and patterns, and make predictions; other applications include creating images, such as graphs and other data visualization, music, computer code; and

**Whereas**, Over the past year, with the release and growth of ChatGPT, Google's Bard, and similar generative AI systems, critics have issued warnings about the impact generative AI could have on society; and

**Whereas**, A May 30, 2023, open letter published by the Center for AI Safety and signed by more than 350 executives, researchers, and engineers working in AI, asserts "[m]itigating the risk of extinction from AI should be a global priority alongside other societal-scale risks such as pandemics and nuclear war"; and

**Whereas**, A nationally representative survey of more than a thousand K-12 teachers and a thousand students published in February 2023 by the polling and research firm Impact Research for the Walton Family Foundation revealed that 51 percent of teachers have used ChatGPT, with 40 percent of teachers saying they use it weekly, and 10 percent reporting they use it almost daily; and

**Whereas**, By comparison, 33 percent of student respondents reported using ChatGPT for school, including 47 percent of those ages 12-14; and

**Whereas**, The survey also found that 59 percent of teachers reported that "ChatGPT will likely have legitimate educational uses that we cannot ignore," while 24 percent reported that "ChatGPT will likely only be useful for students to cheat"; and

**Whereas**, Overall, the survey revealed that teachers and students agree that ChatGPT will be important to incorporate into schooling: 68 percent of students believe it can help them become better students and 75 percent of students reported that it can help them learn faster, while 73 percent of teachers agree that ChatGPT can help their students learn more; and

**Whereas**, Generative AI chatbots, which rely on patterns learned in its training rather than facts, are not reliable sources of information; and

**Whereas**, A May 3, 2023, JSTOR Daily post, highlighted that failing to properly engage with generative AI could produce a "generation of students and professionals who rely on a machine to think for them," ultimately resulting in an "educational landscape where... students will have ChatGPT write their essays, and teachers will have ChatGPT grade them"; and

**Whereas**, In January 2023, citing "concerns about negative impacts on student learning, and concerns regarding the safety and accuracy of content," the New York City ("NYC" or "City") Department of Education (DOE) restricted access to ChatGPT on DOE networks and devices; and

**Whereas**, However, in a first-person piece published May 18, 2023, by Chalkbeat New York, DOE Chancellor Banks conceded that "the reality [is] that our students are participating in and will work in a world where understanding generative AI is crucial"; and

**Whereas**, Education must keep pace and embrace new technology in order to best prepare students for an ever-evolving world; now, therefore, be it

**Resolved**, That the Council of the City of New York calls on the New York City Department of Education to develop curriculum on machine learning, and adapt their current curriculum to account for the safe use of generative AI.

RITA C. JOSEPH, *Chairperson*; FARAH N. LOUIS, JAMES F. GENNARO, ERIC DINOWITZ, OSWALD FELIZ, ALEXA AVILÉS, CARMEN N. De La ROSA, SHAHANA K. HANIF, SHEKAR KRISHNAN, LINDA LEE, JULIE MENIN, MERCEDES NARCISSE, LINCOLN RESTLER, PIERINA ANA SANCHEZ, LYNN C. SCHULMAN, SANDRA UNG.; 16-0-0; *Absent*: Jennifer Gutiérrez, Kamillah Hanks, and Althea V. Stevens; Committee on Education, December 5, 2023.

Pursuant to Rule 8.50 of the Council, the Majority Leader and Acting President Pro Tempore (Council Member Powers) called for a voice vote. Hearing no objections, the Majority Leader and Acting President Pro Tempore (Council Member Powers) declared the Resolution to be adopted.

Adopted unanimously by the Council by voice-vote.

Report for voice-vote Res. No. 766

**Report of the Committee on Education in favor of approving a Resolution calling on the New York City Department of Education to update its CS4All initiative to increase access to CS4All professional development for educators and administrators, particularly for those in underserved schools, and to increase training for all teachers.**

The Committee on Committee on Education, to which the annexed resolution was referred on September 14, 2023 (Minutes, page 2404), respectfully

#### REPORTS:

**(For text of report, please see the Report of the Committee on Education for Int. No. 198-A printed in the Reports of the Standing Committees section of these Minutes)**

*Accordingly, this Committee recommends its adoption.*

**(The following is the text of Res. No. 766:)**

Res. No. 766

**Resolution calling on the New York City Department of Education to update its CS4All initiative to increase access to CS4All professional development for educators and administrators, particularly for those in underserved schools, and to increase training for all teachers.**

By Council Members Joseph, Powers, Gutierrez, Abreu, Stevens, Louis, Schulman, Menin, Fariás, Ossé, Hanif, Krishnan, De La Rosa, Riley, Williams, Rivera, Nurse, Hudson, Gennaro and Narcisse (by request of the Manhattan Borough President).

**Whereas**, Computer science (CS) is the study of computers and computational systems, including the principles, theories, and methods for designing, developing, and utilizing thereof; and

**Whereas**, CS includes the study of algorithms, artificial intelligence (AI), computer architecture, computer networks, databases, operating systems, programming languages, software engineering, and human-computer interaction; and

**Whereas**, CS plays a crucial role in advancing technology, driving innovation, and shaping aspects of everyday life, including communication, entertainment, healthcare, scientific research, and transportation; and

**Whereas**, CS is a rapidly evolving field that continuously pushes the boundaries of what is possible, enabling new discoveries and improving efficiency in all industries and sectors; and

**Whereas**, CS education enhances students’ critical thinking, equipping them with essential skills, providing them with a foundation in computational thinking, problem-solving, and algorithmic reasoning; and

**Whereas**, CS education empowers students to be active creators and contributors to society by encouraging them to think creatively and develop innovative solutions to real world problems; and

**Whereas**, CS education helps students develop digital literacy, including how to navigate technology responsibly, and understanding data privacy, and prepares them for future job opportunities; and

**Whereas**, With the recent public release of generative AI chatbots, digital literacy skills are especially important to know how to evaluate the credibility of, and make informed decisions about, AI-generated content; and

**Whereas**, CS education is particularly important to addressing the digital divide, which refers to the gap in access to technology and digital resources between different socioeconomic groups and communities, including reliable internet connectivity and access to personal devices, among underserved students; and

**Whereas**, The New York City (NYC) Department of Education (DOE) Computer Science for All (CS4All) initiative is a citywide effort to ensure that all public school students have access to CS education; and

**Whereas**, Through CS4All, DOE collaborates with schools, educators, industry partners, and community organizations to develop a comprehensive and inclusive CS curriculum aligned with national standards and best practices; and

**Whereas**, CS4All emphasizes teacher training and professional development to equip educators with the necessary skills and knowledge to effectively teach CS; and

**Whereas**, CS4All came out of DOE’s Equity and Excellence for All agenda and, according to its website, the initiative is committed to “providing every single child, in every classroom, in every [NYC] public school” with a “meaningful, high quality [CS] education at each school level... by 2025”; and

**Whereas**, However, CS4All has been criticized for not doing enough to address the racial and gender disparities that exist in CS education; and

**Whereas**, An October 2022 study by the New York University’s (NYU) Research Alliance on CS4All showed that only 17 percent of DOE schools are meeting the participating and equity goals set for girls, Black, and Latinx students; and

**Whereas**, Moreover, schools that made greater improvement in CS access and participation also served lower percentages of Black and Latinx students on average; and

**Whereas**, The NYU study also found that schools that made greater improvements were more likely to have multiple teachers participate in CS4All professional development and to have an administrator or teacher participate in the CS4All leadership professional development; and

**Whereas**, This suggests that CS4All professional development may have helped facilitate greater access and participation among students; and

**Whereas**, In this increasingly digital world, CS is an essential part of a student’s education; now, therefore, be it

**Resolved**, That the Council of the City of New York calls on the New York City Department of Education to update its CS4All initiative to increase access to CS4All professional development for educators and administrators, particularly for those in underserved schools, and to increase training for all teachers.

RITA C. JOSEPH, *Chairperson*; FARAH N. LOUIS, JAMES F. GENNARO, ERIC DINOWITZ, OSWALD FELIZ, ALEXA AVILÉS, CARMEN N. De La ROSA, SHAHANA K. HANIF, SHEKAR KRISHNAN, LINDA LEE, JULIE MENIN, MERCEDES NARCISSE, LINCOLN RESTLER, PIERINA ANA SANCHEZ, LYNN C. SCHULMAN, SANDRA UNG; 16-0-0; *Absent*: Jennifer Gutiérrez; Kamillah Hanks, and Althea V. Stevens; Committee on Education, December 5, 2023.

Pursuant to Rule 8.50 of the Council, the Majority Leader and Acting President Pro Tempore (Council Member Powers) called for a voice vote. Hearing no objections, the Majority Leader and Acting President Pro Tempore (Council Member Powers) declared the Resolution to be adopted.

Adopted unanimously by the Council by voice-vote.

Report for voice-vote item Res. No. 767

**Report of the Committee on Education in favor of approving a Resolution calling on the New York City Department of Education to mandate training on generative artificial intelligence tools, including for potential classroom implementation, for all educators.**

The Committee on Committee on Education, to which the annexed resolution was referred on September 14, 2023 (Minutes, page 2405), respectfully

**REPORTS:**

**(For text of report, please see the Report of the Committee on Education for Int. No. 198-A printed in the Reports of the Standing Committees section of these Minutes)**

*Accordingly, this Committee recommends its adoption.*

**(The following is the text of Res. No. 767:)**

Res. No. 767

**Resolution calling on the New York City Department of Education to mandate training on generative artificial intelligence tools, including for potential classroom implementation, for all educators.**

By Council Members Joseph, Powers, Gutierrez, Abreu, Schulman, Menin, Farías, Ossé, Hanif, Krishnan, De La Rosa, Riley, Williams, Bottcher, Rivera, Louis, Nurse, Hudson, Brewer and Narcisse (by request of the Manhattan Borough President).

**Whereas**, Generative artificial intelligence (AI) is a type of AI that can generate new content, including text, images, and videos, through learning patterns from pre-existing data; and

**Whereas**, Examples of generative AI systems include image generators, large language models, code generation tools, or audio generation tools; and

**Whereas**, Open AI's ChatGPT, a chatbot powered by an underlying large language model, is trained to follow an instruction in a prompt and provide a detailed response in a humanlike conversational dialogue within seconds; and

**Whereas**, Since its public release, ChatGPT has become the fastest-growing consumer application in history, growing from one million users following its launch in November 2022 to over 100 million users in January 2023; and

**Whereas**, With the release and growth of ChatGPT, Google's Bard, and similar generative AI systems, critics have both touted and condemned the impact of generative AI on society; and

**Whereas**, In a February 23, 2023, Wall Street Journal editorial, Henry Kissinger, Eric Schmidt, and Daniel Huttenlocher claim "[g]enerative [AI] presents a philosophical and practical challenge on a scale not experienced since the start of the Enlightenment" with the invention of the printing press; and

**Whereas**, A widely discussed concern about generative AI has centered around education and the potential for students to improperly use the technology, such as to plagiarize assignments; and

**Whereas**, According to a January 2023 Intelligent.com poll, 30 percent of college students have used ChatGPT on written homework assignments, while research published in March 2023 by the Walton Family Foundation showed that 33 percent of students aged 12 to 17 use ChatGPT for schoolwork; and

**Whereas**, Generative AI chatbots rely on patterns learned in training, which can be based on non-factual information and which could result in false narratives and misinformed outputs; and

**Whereas**, In a first-person piece published May 18, 2023, by Chalkbeat New York, the New York City Department of Education Chancellor David Banks asserted that "the reality [is] that our students are participating in and will work in a world where understanding generative AI is crucial"; and



**Whereas**, For generative AI to be useful and reliable, there must be a concentrated effort and an ongoing conversation in academia to adapt to generative AI, including how it can be effectively integrated into education; and

**Whereas**, Generative AI is a huge technological breakthrough that has the potential to be a valuable resource or have devastating consequences in both education and society; now, therefore, be it

**Resolved**, That the Council of the City of New York calls on the New York City Department of Education to mandate training on generative artificial intelligence tools, including for potential classroom implementation, for all educators.

RITA C. JOSEPH, *Chairperson*; FARAH N. LOUIS, JAMES F. GENNARO, ERIC DINOWITZ, OSWALD FELIZ, ALEXA AVILÉS, CARMEN N. De La ROSA, SHAHANA K. HANIF, SHEKAR KRISHNAN, LINDA LEE, JULIE MENIN, MERCEDES NARCISSE, LINCOLN RESTLER, PIERINA ANA SANCHEZ, LYNN C. SCHULMAN, SANDRA UNG; 16-0-0; *Absent*: Jennifer Gutiérrez; Kamillah Hanks, and Althea V. Stevens; Committee on Education, December 5, 2023.

Pursuant to Rule 8.50 of the Council, the Majority Leader and Acting President Pro Tempore (Council Member Powers) called for a voice vote. Hearing no objections, the Majority Leader and Acting President Pro Tempore (Council Member Powers) declared the Resolution to be adopted.

Adopted unanimously by the Council by voice-vote.

Report for voice-vote item Res. No. 813

**Report of the Committee on Cultural Affairs, Libraries and International Intergroup Relations in favor of approving a Resolution recognizing April 13 annually as Borinqueneers Day in the City of New York in honor of the courage and wartime contributions of the U.S. Army's 65th Infantry Regiment and their lasting legacy.**

The Committee on Committee on Cultural Affairs, Libraries and International Intergroup Relations, to which the annexed resolution was referred on October 19, 2023 (Minutes, page 2739), respectfully

#### **REPORTS:**

(For text of report, please see the Report of the Committee on Cultural Affairs, Libraries and International Intergroup Relations for Int. No. 1184-A printed in the Reports of the Standing Committees section of these Minutes)

*Accordingly, this Committee recommends its adoption.*

**(The following is the text of Res. No. 813:)**

Res. No. 813

**Resolution recognizing April 13 annually as Borinqueneers Day in the City of New York in honor of the courage and wartime contributions of the U.S. Army's 65th Infantry Regiment and their lasting legacy.**

By Council Members Farías, Ayala, Salamanca, Velázquez, Won, Lee, Holden, Rivera, Avilés, Stevens, Brooks-Powers, Hudson, Gutiérrez, Cabán and Gennaro.

**Whereas**, In 1899, Congress authorized the formation of Puerto Rico’s Battalion of Volunteer Infantry, a unit of men primarily from the island of Puerto Rico, which had just become a territory of the United States (U.S.); and

**Whereas**, In 1908, the Battalion became a regiment in the regular U.S. Army; and

**Whereas**, Lieutenant Teófilo Marxuach’s unit from the regiment fired warning shots at a German supply ship trying to leave San Juan Bay, thus marking the first U.S. shots of World War I; and

**Whereas**, Later in World War I, the regiment impressively defended the Panama Canal Zone; and

**Whereas**, After the regiment’s return to Puerto Rico, it was renamed as the 65th Infantry Regiment; and

**Whereas**, The 65th Infantry Regiment served with distinction during World War II in North Africa, France, and Germany; and

**Whereas**, After war in Korea broke out, the 65th Infantry Regiment was sent quickly and arrived in Pusan in 1950, thereafter engaging honorably in many battles during the harsh winter, including fighting off the Chinese People’s Liberation Army in the Chosin Reservoir in order to free the trapped U.S. Army’s First Battalion; and

**Whereas**, The 65th Infantry Regiment protected redeployed Marines in what would become the last battalion-sized bayonet assault in U.S. military history; and

**Whereas**, During the Korean campaign, the 65th Infantry Regiment became known as the Borinqueneers, a name taken from the Taino word for their homeland; and

**Whereas**, In praising the Borinqueneers, General Douglas MacArthur, who had the Regiment under his command, said that they “give daily proofs on the battlefields of Korea of their courage, determination and resolute will to victory” and that they “are writing a brilliant record of heroism in battle”; and

**Whereas**, In spite of great praise from U.S. and Korean military leaders, in 1952, 91 Borinqueneers were court-martialed and jailed for not following orders they deemed insulting and unnecessarily risky; and

**Whereas**, After backlash from Puerto Rico’s government, the U.S. Congress, and the public, the U.S. Army pardoned the Borinqueneers expeditiously and blamed poorly trained and inexperienced new officers, who had trouble communicating with the soldiers, needlessly dangerous military tactics, and ethnic prejudice, which was evident both in and out of battle, for the regrettable courts-martial; and

**Whereas**, The Borinqueneers were cleared by an internal U.S. Army investigation, many hoped for a more substantial vindication, which would finally come more than 60 years later; and

**Whereas**, On May 29, 2014, the New York City Council adopted Resolution Number 103, “urging Congress to pass and the President to sign H.R.1726 and S.1174, to award a Congressional Gold Medal to the 65th Infantry Regiment, known as Borinqueneers”; and

**Whereas**, On June 10, 2014, President Barack Obama signed these bills into law, awarding the Congressional Gold Medal, the highest honor given by Congress, to the Borinqueneers and noting that it is “a proud day for all those whose lives they saved and whose freedom they defended” and that the Borinqueneers have “earned a hallowed place in our history”; and

**Whereas**, On April 13, 2016, Speaker of the House Paul Ryan actually presented the Congressional Gold Medal to the Borinqueneers and remarked that these men “showed us time and again that, courage does not know color”; and

**Whereas**, In addition to the Congressional Gold Medal, the Borinqueneers have earned 10 Distinguished Service Crosses, more than 250 Silver Stars, more than 600 Bronze Stars, and more than 2,700 Purple Hearts, along with commendations from the Republic of Korea, while suffering over 1,500 casualties and over 2,600 wounded; and

**Whereas**, Section 1088 of the National Defense Authorization Act for Fiscal Year 2021 (P.L. 116-283) supported the designation of National Borinqueneers Day and recognized the “bravery, service, and sacrifice of the Puerto Rican soldiers of the 65th Infantry Regiment in the armed conflicts of the United States in the 20th and 21st centuries”; and

**Whereas**, Section 1088 urges Americans on National Borinqueneers Day to participate in activities that celebrate the “distinguished service” and “significant contributions to United States history” of the Borinqueneers and that “pay tribute to the sacrifices made and adversities overcome by Puerto Rican and Hispanic members of the Armed Forces”; and

**Whereas**, Since 2021, April 13 has been officially recognized by Congress as National Borinqueneers Day;

**Whereas**, According to U.S. Census estimates for 2019, New York City (NYC) has a population of more than 650,000 people of Puerto Rican origin, or about 8 percent of NYC's total population; and

**Whereas**, On July 13, 2023, at an annual Gracie Mansion celebration of Puerto Rican heritage, Mayor Eric Adams, who has referred to Puerto Rico as NYC's "sixth borough," commented, "You look into the history and success of this city, you would see over and over again the role that the Puerto Rican community has played and how they ensured and fortified everything that's great about the city";

**Whereas**, Borinqueneers have already been honored in the Bronx with the co-naming of Southern Boulevard as "La 65 de Infanteria Boulevard"; now, therefore, be it

**Resolved**, That the Council of the City of New York recognizes April 13 annually as Borinqueneers Day in the City of New York in honor of the courage and wartime contributions of the U.S. Army's 65th Infantry Regiment and their lasting legacy.

CHI A. OSSÉ, *Chairperson*; FRANCISCO P. MOYA, FARAH N. LOUIS, ERIC DINOWITZ, AMANDA FARÍAS, SHAHANA K. HANIF, CRYSTAL HUDSON, RITA C. JOSEPH; 8-0-0, *Medical*: Sandra Ung; Committee on Cultural Affairs, Libraries and International Intergroup Relations, December 6, 2023.

Pursuant to Rule 8.50 of the Council, the Majority Leader and Acting President Pro Tempore (Council Member Powers) called for a voice vote. Hearing no objections, the Majority Leader and Acting President Pro Tempore (Council Member Powers) declared the Resolution to be adopted.

Adopted unanimously by the Council by voice-vote.

## INTRODUCTION AND READING OF BILLS

Res. No. 847

### **Resolution calling on Congress and the President to stop attacks on animal welfare laws by opposing H.R.4417/S.2019, the Ending Agricultural Trade Suppression (EATS) Act.**

By Council Members Brannan, Hanif and Gutiérrez.

**Whereas**, In many states and cities across the United States, voters and legislators have passed laws protecting farmed animals from egregious cruelty in the factory farming industry, including laws designed to address intensive animal confinement systems that make use of gestation crates, veal crates, battery cages, and force feeding; and

**Whereas**, For example, in 2019, the New York City Council overwhelmingly passed legislation banning the sale of foie gras in New York City because of its heinous production practices; and

**Whereas**, Foie gras is produced through a process known as gavage, where ducks are force-fed a fatty corn-based mixture that engorges their livers, which swell up to 10 times their normal size, leaving the ducks too big to walk or even breathe before they are slaughtered; and

**Whereas**, In 2018, California passed Proposition 12, a ballot measure requiring farmers to provide more space in cages and pens for breeding pigs, egg-laying hens, and calves raised for veal; and

**Whereas**, Proposition 12 banned the sale of pork, eggs, and veal raised in conditions that did not meet the minimum standards for confined pigs, chickens, and calves under California law; and

**Whereas**, In an attempt to continue profiting from cruel confinement practices, the pork industry sued California and lost when the U.S. Supreme Court voted to uphold Proposition 12 in 2023; however, Proposition 12 and similar laws remain under relentless attack from large animal agricultural corporations and trade groups; and

**Whereas**, H.R.4417/ S.2019, known as the Ending Agricultural Trade Suppression (EATS) Act , was introduced in Congress by Representative Ashley Hinson and Senator Robert Marshall, respectively, to strip states and localities of their right to impose standards or conditions on the types of products sold in their marketplaces and the production or manufacturing of agricultural products under their jurisdiction; and

**Whereas**, If this dangerous bill were to become law, years' worth of legislative victories for farmed animals at the state and local level could be imperiled; and

**Whereas**, The bill's broad language could also jeopardize state and local laws that are designed to protect dogs from the cruelty of puppy mills, promote food and food packaging safety, protect rural communities, and preserve the environment; and

**Whereas**, A recent study by Harvard University found that the EATS Act could endanger more than 1,000 public health, safety, and animal welfare laws; and

**Whereas**, The EATS Act will also set an alarming precedent for future agricultural reforms; and

**Whereas**, In letters to the House and Senate Agricultural Committees, 215 Members of Congress voiced their opposition to the EATS Act and warned that the EATS Act will "harm America's small farmers, threaten numerous state laws, and infringe on the fundamental rights of states to establish laws and regulations within their own borders"; and

**Whereas**, While the bill's sponsors claim the EATS Act protects agricultural trade, its real goal is to erase state and local animal welfare regulations that are already in place, and instead to protect large animal agricultural corporations that profit from animal cruelty, worker exploitation, and environmental destruction; now, therefore, be it

**Resolved**, That the Council of the City of New York calls on Congress and the President to stop attacks on animal welfare laws by opposing H.R.4417/S.2019, the Ending Agricultural Trade Suppression (EATS) Act.

Referred to the Committee on Health.

## Int. No. 1251

By Council Members Brooks-Powers, Riley and Gutiérrez.

**A Local Law in relation to requiring regular reports on the redevelopment plans at John F. Kennedy International Airport**

*Be it enacted by the Council as follows:*

Section 1. For the purposes of this local law, the following terms have the following meanings:

“Community benefit agreement” means a public agreement between the contracted entity and community groups that is related to the redevelopment plan, and which requires the provision of specific amenities and/or mitigations to the local community or neighborhood.

“Contracted entity” has the same meaning as such term is defined in section 22-821 of the administrative code of the city of New York.

“Port Authority” means the Port Authority of New York and New Jersey.

“Redevelopment plan” means the John F. Kennedy International Airport redevelopment program.

§ 2. No later than February 1 and August 1 of each year, the contracted entity shall submit to the council a report on the progress of the redevelopment plan and any related community benefit agreements. The report shall include, but need not be limited to:

1. The progress made to date on the redevelopment plan and any changes made to the scope, timeline or budget of the redevelopment plan;

2. Actions taken by the Port Authority pursuant to its agreement with the contracted entity related to the redevelopment plan and any community benefit agreements that are known to the contracted entity, including:

- (a) any property acquisitions or transfers;
- (b) any contracts awarded to architects, engineers, construction firms or other contractors;
- (c) any applications or awards for permits or variances;
- (d) any changes made to airport operations or flight paths;
- (e) the establishment of any advisory boards or committees; and
- (f) any other relevant policies enacted, financing arrangements made, or other procedural actions taken related to the redevelopment plan.

3. An analysis of the impact to date of the redevelopment plan and any community benefit agreements on surrounding communities, including but not limited to impacts on jobs, businesses, traffic, noise and pollution; and

4. Any other information the contracted entity determines may be relevant regarding the redevelopment plan, community benefit agreements, or associated actions of the Port Authority.

§ 3. This local law takes effect immediately and is deemed repealed upon completion of the redevelopment plan.

Referred to the Committee on Economic Development.

## Int. No. 1252

By Council Members Cabán, Hudson, Hanif and Gutiérrez.

**A Local Law in relation to extending the minimum duration of and updating other requirements pertaining to the task force created to address policies related to the treatment and housing of transgender, gender nonconforming, non-binary, and intersex individuals in the custody of the department of correction**

*Be it enacted by the Council as follows:*

Section 1. Section 1 of local law number 145 for the year 2019 is amended to read as follows:

Section 1. a. *Definitions.* For purposes of this local law, the term “correctional health services” means any health care entity designated by the city of New York as the agency or agencies responsible for health services for incarcerated individuals in the care and custody of the department of correction. When the responsibility is contractually shared with an outside provider, this term shall also apply.

b. The board of correction shall convene a task force to review the department of correction’s policies related to the treatment and housing of transgender, gender nonconforming, non-binary, and intersex individuals in the department of correction’s custody.

[b.] c. Such task force shall consist of a representative appointed by the speaker of the council and a representative from each of the following who shall serve at the pleasure of the appointing [agency] officer: the department of correction, correctional health services, the commission on human rights, the mayor’s office to end domestic and gender-based violence, and the [nyc] NYC unity project within the office of the mayor or similar organization[, and the council]. Such task force shall also include at least one representative from each of the following categories, appointed by the board of correction: (i) formerly incarcerated individuals; (ii) individuals formerly or currently incarcerated in the transgender housing unit of the department of correction, to the extent practicable; (iii) service providers that address transgender, gender nonconforming, non-binary, and intersex individuals in the custody of the department of correction; and (iv) local and national organizations that address issues related to transgender, gender nonconforming, non-binary, and intersex individuals. Members of such task force shall elect a chair from among such members.

[c.] d. Any vacancies in the membership of [the] such task force shall be filled in the same manner as the original appointment. All members shall be appointed to [the] such task force within 60 days of the effective date of this local law.

[d.] e. Members of [the] such task force shall serve without compensation and shall meet no less often than on a quarterly basis.

[e.] f. Prior to each meeting of such task force, the members of such task force shall set an agenda for such meeting and prepare a list of questions for the representatives from the department of correction and correctional health services appointed pursuant to subdivision c of this section, which agenda and list shall be delivered to all members of such task force within 7 days prior to such meeting. The representatives from the department of correction and correctional health services appointed pursuant to subdivision c of this section shall present at such meeting information on transgender, gender nonconforming, non-binary, and intersex individuals in the custody of the department of correction that is responsive to the questions prepared pursuant to this subdivision.

g. In addition to presenting the information required pursuant to subdivision f of this section, representatives from the department of correction and correctional health services appointed pursuant to subdivision c of this section shall provide updates at each meeting of such task force on:

1. Any changes to the rules or policies of the department of correction related to the treatment or housing of transgender, gender nonconforming, non-binary, or intersex individuals in the custody of the department of correction; and

2. Each instance in which a transgender, gender nonconforming, non-binary, or intersex individual in the custody of the department of correction was involuntarily moved from one housing unit within such department to another since the last meeting of such task force.

h. Within one year of the formation of [the] such task force, such task force shall submit a report containing recommendations regarding policies related to the treatment and housing of transgender, gender nonconforming, non-binary, and intersex individuals in the department of correction’s custody, and a summary of key findings to the department of correction, mayor and the speaker of the council. Within 90 days of receiving such report, the department of correction shall provide a written response to the board of correction, the mayor, and the council. Each such written report shall be posted on the department of [correction] correction’s and the board of correction’s websites in a format that is searchable and downloadable and that facilitates printing no later than 10 days after it is delivered to the mayor and the council. [The] Such task force shall continue to submit yearly reports thereafter until its termination.

[f. The] i. Such task force shall terminate by determination of the board of correction, but no earlier than one year after the issuance of a [final] fifth yearly report[, to be submitted in the year 2024]. Any time a new correctional facility is built, the board of correction shall have the option to reconvene [the taskforce] such task

*force* for the purpose of reviewing implementation of policies related to the treatment of transgender, gender nonconforming, non-binary, and intersex individuals in such facilities.

§ 2. This local law takes effect immediately. The task force established pursuant to local law number 145 for the year 2019 shall meet within 90 days of such effective date to elect a chair as required by section one of this local law and at such meeting may conduct such other business as such task force deems necessary.

Referred to the Committee on Criminal Justice.

Int. No. 1253

By Council Members De La Rosa, Sanchez, Farías, Krishnan, Hanif, Ayala, Ossé, Cabán, Nurse, Marte, Restler, Gutiérrez, Won, Avilés, Hudson, Louis and the Public Advocate (Mr. Williams).

**A Local Law to amend the administrative code of the city of New York, in relation to permitting street vendors to vend within two feet from the curb**

*Be it enacted by the Council as follows:*

Section 1. Subdivision a of section 17-315 of the administrative code of the city of New York is amended to read as follows:

a. No pushcart shall be placed upon any sidewalk unless said sidewalk has at least a twelve foot clear pedestrian path to be measured from the boundary of any private property to any obstruction in or on the sidewalk, or if there are no obstructions, to the curb. [In no event shall any pushcart be placed on any part of a sidewalk other than that which abuts the curb.] *All pushcarts on the sidewalk must be placed within two feet from the curb. Where an obstruction prevents such placement, pushcarts must be placed as close as possible to the obstruction.*

§ 2. Subdivision a of section 20-465 of the administrative code of the city of New York is amended to read as follows:

a. No general vendor shall engage in any vending business on any sidewalk unless such sidewalk has at least a twelve-foot wide clear pedestrian path to be measured from the boundary of any private property to any obstructions in or on the sidewalk, or if there are no obstructions, to the curb. [In no event shall any pushcart or stand be placed on any part of a sidewalk other than that which abuts the curb.] *All pushcarts on the sidewalk must be placed within two feet from the curb. Where an obstruction prevents such placement, pushcarts must be placed as close as possible to the obstruction.*

§ 3. This law shall take effect 120 days after it becomes law.

Referred to the Committee on Consumer and Worker Protection.

Int. No. 1254

By Council Members Farías, Hudson and Restler.

**A Local Law to amend the administrative code of the city of New York, in relation to restricting non-essential helicopter operations at city heliports to helicopters powered fully by electric engines**

*Be it enacted by the Council as follows:*

Section 1. Subchapter 2 of chapter 8 of title 22 of the administrative code of the city of New York is amended by adding a new section 22-827 to read as follows:

§ 22-827 *Heliport operations. a. Definitions. For the purposes of this section, the following terms have the following meanings:*

*Covered helicopters. The term “covered helicopter” means a rotary-wing aircraft powered by a combustion engine capable of vertical takeoff and landing. Such term does not include helicopters powered fully by electric engines.*

*Heliport. The term “heliport” means a designated land area used for helicopter operations and any appurtenant areas, including fueling facilities, terminal buildings and maintenance and repair facilities.*

*Non-essential flight. The term “non-essential flight” means any helicopter flight not conducted by or on behalf of (i) the United States armed forces, (ii) the fire department, (iii) emergency services, including any air ambulance, (iv) the police department or other law enforcement entity, or (v) a newsgathering organization.*

*Newsgathering organization. The term “newsgathering organization” means an organization or entity that gathers and reports the news by publishing, broadcasting, or cablecasting articles, commentaries, books, photographs, video, film, or audio by electronic, print, or digital media such as radio, television, newspapers, magazines, wire, books, and the internet.*

*b. The commissioner shall require any contracted entity operating, managing or otherwise responsible for a heliport on any property owned by the city of New York to prohibit covered helicopters from conducting non-essential flights to or from any city-owned heliport.*

§ 3. This local law takes effect 180 days after enactment.

Referred to the Committee on Economic Development.

Int. No. 1255

By Council Members Farías, Hanif, Hudson and Restler.

**A Local Law to amend the administrative code of the city of New York, in relation to monitoring helicopter noise**

*Be it enacted by the Council as follows:*

Section 1. Subchapter 2 of chapter 2 of title 24 of the administrative code of the city of New York is amended by adding a new section 24-217.2 to read as follows:

§ 24-217.2 *Monitoring helicopter noise. a. Definitions. For the purposes of this section, the term “city building” means a building or structure that is (i) owned or leased by the city; and (ii) managed or operated by the city.*

*b. The commissioner shall identify areas of the city that commonly experience noise due to helicopters. Such identification shall be based on frequently used helicopter flight paths, helicopter routes recommended by the federal aviation administration, the locations of 311 helicopter noise complaints, and any other factors the commissioner deems appropriate. Within such areas, the commissioner shall:*

- 1. Install a sound level meter of the roof of each city building;*
- 2. In collaboration with the commissioner of transportation, install a sound level meter on the top of each street light; and*
- 3. Install, free of charge, a sound level meter on the roof of any privately-owned building where the owner has requested such installation.*

*c. No less frequently than once every 2 years, the commissioner shall reassess the areas identified pursuant to subdivision b of this section and identify any new areas that frequently experience helicopter noise.*

*d. The sound level meters required pursuant to paragraphs 1 and 2 of subdivision b of this section shall be installed no later than 6 months after (i) the effective date of the local law that added this section and (ii) any date that the commissioner identifies a new area pursuant to subdivision c of this section.*

*e. No later than 1 year after the effective date of the local law that added this section, and every month thereafter, the department shall post on its website a report of the decibel levels detected by each sound level meter installed pursuant to subdivision b of this section. The report shall include a separate row for each unique*



*meter reading, reported at intervals of no greater than 5 seconds for each sound level meter, and such row shall include the following information set forth in separate columns:*

- 1. The date and time at which the meter reading occurred;*
- 2. A unique identification code corresponding to the sound level meter;*
- 3. The latitude and longitude at which the meter reading occurred;*
- 4. The altitude above sea level at which the meter reading occurred, as determined by global positioning systems technology; and*
- 5. The decibel level detected.*

§ 2. This local law takes effect immediately.

Referred to the Committee on Environmental Protection, Resiliency and Waterfronts.

Int. No. 1256

By Council Members Farías, Riley, Hanif, Hudson and Gutiérrez.

**A Local Law to amend the administrative code of the city of New York, in relation to requiring the establishment of a municipal human milk bank**

*Be it enacted by the Council as follows:*

Section 1. Chapter 1 of title 17 of the administrative code of the city of New York is amended by adding a new section 17-199.25 to read as follows:

*§ 17-199.25 Municipal human milk bank. a. Definitions. As used in this section, the term “human milk bank” means an organized service for the selection of donors and the collection, processing, storage, or distribution of human breast milk for infants or children other than the donor’s own infant.*

*b. Human milk bank. The department, or another agency or entity designated by the mayor, shall take all necessary steps to obtain any required licenses or approvals to establish and operate a human milk bank and, upon receipt of such licenses or approval, establish and operate a human milk bank.*

§ 2. This local law takes effect 30 days after it becomes law.

Referred to the Committee on Health.

Int. No. 1257

By Council Members Farías, Riley, Hanif and Hudson.

**A Local Law to amend the administrative code of the city of New York, in relation to requiring a training program for first responders and an awareness campaign regarding domestic violence-related traumatic brain injuries**

*Be it enacted by the Council as follows:*

Section 1. Definitions. For purposes of this local law, the following terms have the following meanings:  
City. The term “city” means the city of New York.

Designated citywide languages. The term “designated citywide languages” has the same meaning as set forth in subdivision a of section 23-1101 of the administrative code of the city of New York.

Domestic violence. The term “domestic violence” means acts or threats of violence, not including acts of self-defense, committed by a family or household member against another family or household members.

First responder. The term “first responder” means a person with specialized training who is among the first to arrive and provide assistance or incident resolution at the scene of an emergency including, but not limited to, law enforcement officers, paramedics, emergency health technicians, and firefighters.

§ 2. Training. No later than 180 days after the effective date of this local law, the city shall conduct training on the topic of traumatic brain injury, to be provided to first responders to incidents involving domestic violence, for the purpose of promoting awareness of the connection between domestic violence and traumatic brain injury, the symptoms of such injury, and effective methods of addressing the needs of individuals in an emergency who suffer from such injury. All first responders employed by the police department and the fire department shall complete such training. The department of health and mental hygiene shall offer such training to members of the public including first responders to incidents involving domestic violence, domestic violence service providers, and client advocates.

§ 3 Training content. The commissioner of health and mental hygiene, the police commissioner, and the fire commissioner shall collaborate to develop the training required by section two of this local law. Training sessions may be designed to meet the specific needs of training participants, or address issues of specific relevance to such participants, and at minimum shall include instruction in relation to the following:

- a. The prevalence of traumatic brain injury cases among domestic violence survivors;
- b. How to identify symptoms of traumatic brain injury;
- c. How to respond to traumatic brain injury; and
- d. The long-term health effects associated with repeated occurrences of traumatic brain injury.

§ 4. Campaign. No later than 180 days after the effective date of this local law, the department of health and mental hygiene, in collaboration with the mayor’s office to end domestic and gender-based violence, shall conduct a public awareness campaign to destigmatize and increase understanding of the connection between domestic violence and traumatic brain injury, and the long-term health effects associated with repeated occurrences of traumatic brain injury. Such campaign shall include physical and digital materials. Such materials shall be made available in the designated citywide languages and posted on the city’s website.

§ 5. Paragraph 1 of subdivision b of section 14-192, as added by local law number 49 for the year 2022, is amended to read as follows:

1. The department shall develop, and implement by September 30, 2022, a victim-centered, trauma-informed questioning training program designed to develop skills for the response to and investigation of incidents involving domestic violence, sexual crimes, or human trafficking. The training program shall include but not be limited to the following components: the dynamics of domestic violence, sexual assault, and human trafficking, including abuser tactics of power and control; danger and lethality factors in domestic violence, sexual assault, and human trafficking cases; the criminal law provisions of the Family Protection Domestic Violence Intervention Act of 1994, codified in chapter 222 of the laws of 1994; how to determine the primary aggressor in a domestic violence incident; the family offenses; the offense of endangering the welfare of a child; the offenses of assault in the first degree, manslaughter in the first and second degrees, criminally negligent homicide, and murder in the second degree, together with the defense of justification and the role of trauma in victims' acts of self-defense; the importance of avoiding expressions of skepticism, victim-blaming, and minimizing of the offense in early communications with victims; how to recognize signs of drug-facilitated sexual assault and preserve crucial evidence thereof; the overlap among domestic violence, sexual assault and human trafficking; victim-centered, trauma-informed questioning in domestic violence, sexual assault, human trafficking, and related cases; the effects of trauma on victims; *the long-term health implications of physical violence including, but not limited to, traumatic brain injury*; techniques of trauma-informed policing; the resources available to victims of domestic violence, sexual assault, and human trafficking, including shelter and nonresidential services, locating hospital-based sexual assault forensic exams, and domestic violence, sexual assault, and human trafficking emergency resources; and any other training deemed relevant by the commissioner, except that the commissioner may eliminate a training component or replace a training component with an alternative component in order to provide a comprehensive victim-centered, trauma-informed questioning training program.

§ 6. This local law takes effect immediately.

Referred to the Committee on Health.

## Int. No. 1258

By Council Members Farías, Hanif and Hudson.

**A Local Law to amend the administrative code of the city of New York, in relation to the installation of electric vehicle charging equipment on lampposts**

*Be it enacted by the Council as follows:*

Section 1. Subchapter 1 of chapter 1 of title 19 of the administrative code of the city of New York is amended by adding a new section 19-159.8 to read as follows:

*§ 19-159.8 Lamppost charging stations for electric vehicles. a. The commissioner shall annually determine the feasibility of installing charging equipment for electric vehicles on lampposts under the commissioner's jurisdiction, considering the availability of such equipment and related installation services, cost, location, compatibility with traffic rules and regulations, and any other factor deemed appropriate by the commissioner. As part of this determination and in consultation with the police department, the commissioner shall determine which such lampposts should be reconfigured for installation of such equipment.*

*b. The commissioner shall install such equipment on lampposts in accordance with the feasibility determination made pursuant to subdivision a.*

§ 2. This local law takes effect 120 days after becoming law.

Referred to the Committee on Transportation and Infrastructure.

## Res. No. 848

**Resolution calling on the New York State Legislature to pass, and the Governor to sign, legislation amending the Public Officers Law to allow non-citizens to hold civil offices.**

By Council Members Farías, Hanif and Hudson.

**Whereas**, The New York State Public Officers Law requires anyone holding a civil office to be a citizen of the United States; and

**Whereas**, New York City has over 100 boards and commissions;

**Whereas**, Many members of boards and commissions hold a civil office under the Public Officers Law, and therefore must be a citizen of the United States; and

**Whereas**, According to the Mayor's Office of Immigrant Affairs, New York City had over 1.2 million non-citizen residents in 2022; and

**Whereas**, Non-citizen New Yorkers pay taxes, own business and send their children to public schools; and

**Whereas**, New York City needs civil officer holders who have experiences that reflect those of all New Yorkers, including non-citizen New Yorkers; and

**Whereas**, Many civil officer positions require specific skills or experiences; and

**Whereas**, Non-Citizen New Yorkers have a variety of different skills and experiences; and

**Whereas**, Non-citizen New Yorkers have the skills and experiences required to fill certain civil officer positions; and

**Whereas**, Non-citizen New Yorkers are an essential part of the fabric of New York City; now, therefore, be it

**Resolved**, That the Council of the City of New York calls on the New York State Legislature to pass, and the Governor to sign, legislation amending the Public Officers Law to allow non-citizens to hold civil offices.

Referred to the Committee on Governmental Operations.

## Int. No. 1259

By Council Member Holden.

**A Local Law to amend the administrative code of New York, in relation to requiring bicyclists to wear protective headgear**

*Be it enacted by the Council as follows:*

Section 1. Subchapter 2 of chapter 1 of title 19 of the administrative code of the city of New York is amended by adding a new section 19-171.3 to read as follows:

*§ 19-171.3 Protective headgear requirement for bicyclists. a. Definitions. As used in this section, the following terms have the following meanings:*

*Bicycle. The term “bicycle” has the same meaning as set forth in section 10-157.*

*Protective headgear. The term “protective headgear” has the same meaning as set forth in either (i) section 10-157, including any successor provisions, or (ii) section 1238 of the vehicle and traffic law, including any successor provisions, and it is not missing component parts or damaged in a way that impairs its functionality.*

*b. No person shall ride upon or operate a bicycle without wearing protective headgear of good fit fastened securely upon the head with the headgear straps.*

*c. Any person who violates subdivision b of this section is liable for a civil penalty not to exceed \$50.*

*d. This section shall not apply to any person who is subject to the helmet or protective headgear requirements of section 1238 of the vehicle and traffic law or paragraph (2) of subdivision e of section 10-157.*

*§ 2. This local law takes effect 120 days after it becomes law.*

Referred to the Committee on Transportation and Infrastructure.

## Int. No. 1260

By Council Members Holden, Feliz, and Bottcher.

**A Local Law to amend the administrative code of the city of New York, in relation to prohibiting the parking, standing, stopping, or operation of a motor vehicle with obscured or defaced license plates**

*Be it enacted by the Council as follows:*

Section 1. Subchapter 2 of chapter 1 of title 19 of the administrative code of the city of New York is amended by adding a new section 19-175.9 to read as follows:

*§ 19-175.9 Obscured or defaced license plates. a. Definitions. For purposes of this section, the term “obscured or defaced license plate” means any license plate that does not comply with the requirements and prohibitions set forth in paragraph (b) of subdivision 1 of section 402 of the vehicle and traffic law.*

*b. Prohibitions. 1. It is unlawful for any person to park, stand, or stop a motor vehicle with an obscured or defaced license plate.*

*2. It is unlawful for any person to operate a motor vehicle with an obscured or defaced license plate.*

*c. Penalties. 1. The violation of paragraph 1 of subdivision b of this section shall constitute a misdemeanor punishable by a fine of not more than \$1,000, or by imprisonment not to exceed 20 days, or both.*

*2. Any person who violates paragraph 1 of subdivision b of this section is liable for any monetary penalties applicable pursuant to the vehicle and traffic law.*

*3. The violation of paragraph 2 of subdivision b of this section shall constitute a misdemeanor punishable by a fine of not more than \$1,000, or by imprisonment not to exceed 20 days, or both.*

*4. Any person who violates paragraph 2 of subdivision b of this section is liable for a civil penalty of \$500 for a first violation and \$1,000 for each subsequent violation committed within 6 months of a first violation.*

§ 2. This local law takes effect 60 days after becoming law.

Referred to the Committee on Transportation and Infrastructure.

Int. No. 1261

By Council Member Hudson.

**A Local Law to amend the administrative code of the city of New York, in relation to the creation of a residential parking permit system in Northwestern Brooklyn**

*Be it enacted by the Council as follows:*

Section 1. Subchapter 2 of chapter 1 of title 19 of the administrative code of the city of New York is amended by adding a new section 19-175.8 to read as follows:

§ 19-175.8 *Residential parking permit system in Northwestern Brooklyn.* a. *The department shall create and implement a residential parking permit system in Northwestern Brooklyn, to include the area bounded by DeKalb Avenue to the north, Bond Street to the west, Union Street to the south and Vanderbilt Avenue to the east, which fixes and requires the payment of fees applicable to parking within the area in which such parking system is in effect in accordance with the provisions of this section.*

b. *In creating such residential parking system, the department shall:*

1. *Designate the specific areas in which such parking system applies;*
2. *Provide the times of the day and days of the week during which permit requirements shall be in effect;*
3. *Make not less than 20 percent of all spaces within the permit area available to non-residents and provide for short-term parking of not less than 90 minutes in duration in such area;*
4. *Provide that motor vehicles registered pursuant to section 404-a of the vehicle and traffic law be exempt from any permit requirement;*
5. *Provide the schedule of fees to be paid for residential permits; and*
6. *Provide that such fees shall be credited to the general fund of the city of New York.*

c. *Notwithstanding the provisions of this section, no such residential parking permit shall be required on streets where the adjacent properties are zoned for commercial, office or retail use.*

§ 2. This local law takes effect 120 days after it becomes law.

Referred to the Committee on Transportation and Infrastructure.

Int. No. 1262

By Council Members Hudson, Ayala and Won.

**A Local Law to amend the administrative code of the city of New York, in relation to indirect costs of nonprofit city service contractors**

*Be it enacted by the Council as follows:*

Section 1. Chapter 1 of title 6 of the administrative code of the city of New York is amended by adding a new section 6-148 to read as follows:

§ 6-148 *Indirect costs of city service provision.* a. *Definitions.* *As used in this section, the following terms have the following meanings:*

*City chief procurement officer.* *The term “city chief procurement officer” means the person to whom the mayor has delegated authority to coordinate and oversee the procurement activity of mayoral agency staff, including the agency chief contracting officers and any offices that have oversight responsibility for procurement.*

*City service contract.* The term “city service contract” means any written agreement, except an emergency contract procured pursuant to the procedure set forth in section 315 of the charter, between any person and an agency whereby: (i) an agency is committed to expend or does expend funds; and (ii) the principal purpose of such agreement is to provide human services.

*Covered city service contractor.* The term “covered city service contractor” means any nonprofit organization that enters into or renews a city service contract with an agency after the effective date of the local law that added this section. Such organization shall be deemed a city service contractor for the duration of the city service contract that the organization enters into.

*Indirect cost.* The term “indirect cost” means a cost incurred for a common or joint purpose, such as general facilities and administrative costs, which is not readily assignable to a single program, work stream, project, or contract.

*NICRA.* The term “NICRA” means a negotiated indirect cost rate agreement issued by the federal government in accordance with part 200 of title 2 of the code of federal regulations, regarding uniform administrative requirements, cost principles, and audit requirements for federal awards, or a successor provision.

*Nonprofit organization.* The term “nonprofit organization” means an entity that is either incorporated as a not-for-profit corporation under the laws of the state of its incorporation or exempt from federal income tax pursuant to subdivision c of section 501 of the internal revenue code.

b. The city chief procurement officer and the director of the office of management and budget, or another officer or agency head designated by the mayor, in consultation with the executive director of the office of not-for-profit organization services, shall develop a methodology pursuant to which nonprofit organizations may calculate the indirect costs associated with the delivery of services pursuant to a city service contract. The methodology shall also allow organizations to establish an indirect cost rate pursuant to the terms of subdivision c of this section. Such methodology and any related materials, including any applicable guidelines, shall be made available on the website of the office of not-for-profit organization services.

c. As an alternative to calculating indirect costs pursuant to the methodology established in subdivision b of this section, a nonprofit organization may elect to establish an indirect cost rate by using:

1. A de minimis indirect cost rate of 20 percent of direct project costs;
2. An indirect cost rate received by the nonprofit organization pursuant to a NICRA or extension thereto that is in effect as of the effective date of the city service contract; or
3. An indirect cost rate received by the nonprofit organization pursuant to an agreement or extension thereto that is (i) in effect as of the effective date of the city service contract and (ii) with one of the contracting entities identified pursuant to subdivision d of this section.

d. The city chief procurement officer and the director of the office of management and budget, or another officer or agency head designated by the mayor, in consultation with the executive director of the office of not-for-profit organization services, shall develop a list of federal, state, or other contracting entities that approve indirect cost rates for nonprofit organizations, and whose approved rates may be accepted pursuant to paragraph 3 of subdivision c of this section.

e. The list required pursuant to subdivision d of this section and any relevant guidelines for establishing an indirect cost rate pursuant to subdivision c of this section shall be included with the related materials published pursuant to subdivision b of this section and shall be reviewed and updated at a minimum every 5 years.

f. The contracting agency or another officer or agency designated by the mayor shall reimburse indirect costs incurred by covered city service contractors in the amounts determined in accordance with the methodology developed pursuant to subdivision b of this section.

g. The website of each agency shall provide a link to the methodology and any related materials developed and published pursuant to subdivision b of this section.

§ 2. This local law takes effect 45 days after it becomes law.

Referred to the Committee on Contracts.

## Int. No. 1263

By Council Members Hudson, Bottcher, Hanif and Restler.

**A Local Law in relation to requiring the commissioner of sanitation to study the feasibility and potential environmental effects of a recycling mandate for household textiles**

*Be it enacted by the Council as follows:*

Section 1. a. Definitions. For the purposes of this section, the following terms have the following meanings:  
Commissioner. The term “commissioner” means the commissioner of sanitation.

Department. The term “department” means the department of sanitation.

Recycling. The term “recycling” means any process by which recyclable materials are separated, collected, processed, marketed, and returned to the economy in the form of raw materials or products.

Textile. The term “textile” means cloth, fabric, and other flexible materials made of animal skin, hair, fur, or fleece; plants; minerals; or synthetic materials.

b. No later than 1 year after the effective date of this local law, the commissioner shall submit to the council and to the mayor a report on the feasibility and potential environmental effects of a mandate for the source separation by households and the collection by the department of textiles for recycling and reuse and whether the implementation of such mandate would require a municipal textile recycling facility to process collected textiles. Such report shall include, but need not be limited to:

1. An evaluation of market demand for recycled and reused textiles, including whether there is greater demand for certain types of textiles, and potential impacts of recycling mandates on market demand;

2. A comparison of the net cost to the department, at the time of the report, of collecting, processing, recycling, reusing, and disposing of textile waste with the projected net cost of collecting, processing, recycling, reusing, and disposing of textile waste if the recycling mandate is implemented;

3. An evaluation of the potential benefits to the environment resulting from the recycling mandate, including reductions in greenhouse gases and pollution;

4. A discussion of the potential negative effects of the recycling mandate, including the possibility of increased consumption of textiles caused by perceptions that textile recycling has eliminated the negative environmental effects of textile disposal and impacts on non-profits and other private entities that currently collect textiles for recycling;

5. An estimate of what percentage of textiles collected under the recycling mandate would ultimately be recycled, reused, or landfilled, taking into account whether such textiles would likely be transferred to a third party after collection or processing and how such a third party would likely dispose of such textiles, and actions the commissioner could implement to increase the percentage of collected textiles that are recycled or reused;

6. An assessment of whether the recycling mandate would require a municipal recycling facility to process the collected textiles, including the capacity of existing private recycling facilities and the costs of contracting with existing private recycling facilities compared with the costs of establishing and operating a municipal facility;

7. An assessment of the advantages and disadvantages of partnerships with private entities to collect textiles and operate textile recycling facilities; and

8. A discussion of any potential barriers to department collection of textiles and any other information relevant to assessing the feasibility the recycling mandate.

§ 2. This local law takes effect immediately.

Referred to the Committee on Sanitation and Solid Waste Management.

## Int. No. 1264

By Council Members Krishnan, Sanchez, Farías, De La Rosa, Hanif, Ayala, Ossé, Cabán, Nurse, Marte, Restler, Gutiérrez, Won, Avilés, Hudson, Louis and the Public Advocate (Mr. Williams).

**A Local Law to amend the administrative code of the city of New York, in relation to repealing the misdemeanor criminal penalties for general vendors and mobile food vendors**

*Be it enacted by the Council as follows:*

Section 1. Subdivision a of section 17-325 of the administrative code of the city of New York is amended to read as follows:

a. [Any person who violates the provisions] *The violation* of subdivision a, b, or c of section 17-307 of this subchapter shall [be guilty of a misdemeanor] *constitute an offense*, punishable by a fine of not [less than one hundred fifty dollars nor] more than [one thousand dollars] \$1,000[, or by imprisonment for not more than three months or by such fine and imprisonment].

§ 2. Subdivisions a and e of section 20-472 of the administrative code of the city of New York, subdivision a of such code as amended by local law number 63 for the year 1990, and subdivision e of such code as amended by local law number 14 for the year 1995, are amended to read as follows:

a. [Any person who violates the provisions] *The violation* of sections 20-453 and 20-474.1 of this subchapter shall [be guilty of a misdemeanor] *constitute an offense* punishable by a fine of not [less than two hundred fifty dollars nor] more than [one thousand dollars] \$1,000[, or by imprisonment for not more than three months or by both such fine and imprisonment]. In addition, any police officer may seize any vehicle used to transport goods to a general vendor, along with the goods contained therein, where the driver is required to but cannot produce evidence of a distributor's license. Any vehicle and goods so seized may be subject to forfeiture upon notice and judicial determination. If a forfeiture proceeding is not commenced, the owner or other person lawfully entitled to possession of such vehicle and goods may be charged with the reasonable cost for removal and storage payable prior to the release of such vehicle and goods, unless the charge of unlicensed distributing has been dismissed.

e. [Any person who violates the provisions] *The violation* of sections 20-465 and 20-465.1 of this subchapter and any rules promulgated thereunder shall [be guilty of a misdemeanor] *constitute an offense* punishable by a fine of not more than [five hundred dollars, or by imprisonment for not more than thirty days or by both such fine and imprisonment] \$500.

§ 3. This local law takes effect immediately.

Referred to the Committee on Consumer and Worker Protection.

Res. No. 849

**Resolution designating December 4 annually as Jay-Z Day in the City of New York and celebrating his legendary status as a masterful MC and lyricist and as an innovative entrepreneur.**

By Council Members Louis, Ossé, Riley, Hudson and Gutiérrez.

**Whereas**, Shawn Carter was born on December 4, 1969, in Brooklyn, grew up in the Marcy housing projects in Bedford-Stuyvesant, began penning rhymes at the age of nine, and became one of Hip Hop's most renowned MCs (master of ceremonies) and lyricists, known to his fans around the world by countless nicknames over his storied career, including Jazzy, Jigga, Hova, HOV, and Jay-Z; and

**Whereas**, By his teen years, Jay-Z became known for not writing down his brilliantly composed lyrics, but simply memorizing them as he wrote them, or, as he explained in his own memoir *Decoded*, finding “little corners in my head where I stored rhymes”; and

**Whereas**, According to *The New York Times*, this “love of words would give Jay-Z more number 1 albums than Elvis” or indeed any other solo artist, with a total of 14 so far; and

**Whereas**, Jay-Z first attracted widespread attention in “Show & Prove,” the celebrated posse cut from Big Daddy Kane's 1994 album *Daddy's Home*, which memorably showcased Big Daddy Kane trading verses with Scoob, Sauce Money, Shyheim, Ol' Dirty Bastard, and the relative newcomer Jay-Z; and

**Whereas**, Many years later in 2012, Jay-Z honored Big Daddy Kane by choosing him as the sole guest star for Jay-Z's eight-show opening of Brooklyn's Barclays Center; and



**Whereas**, Jay-Z launched his business career with the founding of Roc-A-Fella Records and released his debut album, the critically acclaimed *Reasonable Doubt*, in 1996; and

**Whereas**, “Dead Presidents II” from *Reasonable Doubt*, named by *Rolling Stone* as number 2 on the list of Jay-Z’s 50 greatest songs, refers poignantly to the shooting of a childhood friend and to his own brushes with gun violence; and

**Whereas**, According to *Rolling Stone*, “Brooklyn’s Finest” from *Reasonable Doubt*, named by *Rolling Stone* as number 6 on the list of Jay-Z’s 50 greatest songs and featuring the Notorious B.I.G., shows off perhaps Brooklyn’s two greatest rappers trading “ever more ridiculous crime boasts,” including Jay-Z’s line “Peep the style and the way the cops sweat us”; and

**Whereas**, According to Billboard, Jay-Z’s top five biggest albums include *Vol. 2...Hard Knock Life* (1998), which was his first GRAMMY Award win, *The Blueprint* (2001), and *The Black Album* (2003); and

**Whereas**, According to *Rolling Stone*, “Hard Knock Life (Ghetto Anthem)” from *Vol. 2...Hard Knock Life*, named by *Rolling Stone* as number 9 on the list of Jay-Z’s 50 greatest songs, was Jay-Z’s first single on the Top 15 pop charts and was based on the famous tune from the Broadway show *Annie*; and

**Whereas**, Jay-Z wrote in *Decoded* about “Hard Knock Life” that he “found a mirror between the two stories—that Annie’s story was mine, and mine was hers, and the song was the place where our experiences weren’t contradictions, just different dimensions of the same reality”; and

**Whereas**, According to *Rolling Stone* magazine’s 500 greatest albums of all time, *The Blueprint* comes in at number 50 and includes “Takeover,” described as “one of rap’s most precise and unrelenting diss tracks” in which Jay-Z famously “commits GBH [grievous bodily harm] on Nas and Prodigy from Mobb Deep”; and

**Whereas**, As a result of “Takeover,” the Jay-Z and Nas beef became one of rap’s hottest, with Jay-Z offering these lines on the song to explain why he had sampled Nas on two earlier songs: “So yeah I sampled your voice, you was usin’ it wrong/You made it a hot line, I made it a hot song”; and

**Whereas**, According to *Rolling Stone*, Jay-Z “elevates clever rhymes and innovations with an unmatched air of calm control and a cavalier confidence” on *The Blueprint*; and

**Whereas**, Jay-Z’s first top 10 hit was “Izzo (H.O.V.A.)” (from *The Blueprint*), and he now boasts 22 Billboard top 10 Hot 100 songs, with the longest-running number one hit “Empire State of Mind,” with Alicia Keys, about which he wrote that he decided to “tell stories of the city’s gritty side, to use stories about hustling and getting hustled to add tension to the soaring beauty of the chorus”; and

**Whereas**, According to *Rolling Stone*, “99 Problems” (from *The Black Album*), named by *Rolling Stone* as number 4 on the list of Jay-Z’s 50 greatest songs and put together with Rick Rubin, had “vintage heavy metal riffery reminiscent of Rubin’s Eighties work...but lyrically it was a blistering, modern-day critique, taking aim at those who demonize [Jay-Z] as a black man and rapper”; and

**Whereas**, “Crazy in Love,” a 2003 Beyoncé single from her debut album *Dangerously in Love*, came in at number 16 on *Rolling Stone*’s list of the 500 best songs of all time and featured a “killer verse” by her future husband Jay-Z.; and

**Whereas**, According to *Rolling Stone*, “4:44,” named by *Rolling Stone* as number 15 on the list of Jay-Z’s 50 greatest songs and the title track of his *4:44* album (2017), was described by Jay-Z as “one of the best songs I’ve ever written” and discusses his marital infidelities with a “vulnerability long lurking but never revealed in such a deliberate fashion”; and

**Whereas**, His impressive business career continued after the founding of Roc-A-Fella Records with his presidency of Def Jam Recordings for three years and with his 2008 founding of Roc Nation, which oversees a record label, management agency, a clothing line (Rocawear), a streaming service (Tidal), and philanthropies and which has expanded to include partnerships with a wide variety of corporations, organizations, and institutions; and

**Whereas**, Jay-Z’s career is one of remarkable longevity, being one of only two artists to score a top 10 hit in Billboard’s Hot 100 in four different decades from the 1990s to the 2020s; and

**Whereas**, Jay-Z has earned 88 GRAMMY Award nominations and boasts 24 wins, including for best rap song, best rap performance, best rap solo performance, best R & B song, best R & B performance, best rap/sung collaboration, best rap duo/group performance, best urban contemporary album, and best music video; and

**Whereas**, Jay-Z writes near the end of *Decoded*, “We were kids without fathers, so we found our fathers on wax and on the streets and in history, and in a way, that was a gift...Our fathers were gone...but we took their old records and used them to build something fresh”; and

**Whereas**, Jay-Z's career was commemorated in 2023 with *The Book of HOV* exhibit at the Brooklyn Public Library's main branch; and

**Whereas**, Jay-Z and the Hon. Dr. Gloria Carter, his mother, founded the Shawn Carter Foundation 20 years ago to open up educational opportunities through college scholarships and more for young people who otherwise might not have access to them; and

**Whereas**, It is unthinkable to celebrate 50 years of Hip Hop without noting the monumental success of a kid from Bed-Stuy, who changed the face of the industry in New York City and beyond; now, therefore, be it

**Resolved**, That the Council of the City of New York designates December 4 annually as Jay-Z Day in the City of New York and celebrates his legendary status as a masterful MC and lyricist and as an innovative entrepreneur.

Referred to the Committee on Cultural Affairs, Libraries and International Intergroup Relations.

Res. No. 850

**Resolution calling on the New York State Legislature to pass, and the Governor to sign, A.7493, establishing a coordinator for asylum seeker services.**

By Council Members Menin, Riley, Hanif, Hudson and Gutiérrez.

**Whereas**, New York City has welcomed over 130,000 migrants and asylum seekers over the last year; and

**Whereas**, Although roughly 65,000 remain in the care of the city, many have left the shelter system and continue to live in New York City; and

**Whereas**, Coordination of services for migrants and asylum seekers can be complex, including ensuring they have access to health care, education, and other benefits; and

**Whereas**, In New York City, this coordination has included multiple agencies; and

**Whereas**, However, asylum seeker coordination with state agencies and entities has been limited; and

**Whereas**, Without effective coordination, asylum seekers could be missing out on services and benefits that would improve their lives and increase their independence and self-sufficiency; and

**Whereas**, A.7493, introduced by Assembly Member Jenifer Rajkumar and pending in the New York State Assembly, seeks to amend the executive law, in relation to establishing a coordinator for asylum seeker services; and

**Whereas**, A.7493 would establish a coordinator responsible for responding to the needs of asylum seekers across the state, including intake, resettlement throughout New York, support services, health care, housing, education, language services, transportation, and accessing federal programs and services; and

**Whereas**, The coordinator would also be responsible for advocacy for asylum related issues; and

**Whereas**, A. 7493 stipulates that the coordinator would oversee the integration of services and benefits with the applicable state, federal, and local agencies, including the Office of Temporary and Disability Assistance and the Office of Children and Family Services; and

**Whereas**, A.7493 would apply to migrants who have applied for asylum; and

**Whereas**, A.7493 would ensure that the state is involved in the leadership and coordination in managing this asylum seeker influx, easing the strain that has been put on the city to manage this influx; and

**Whereas**, An asylum seeker coordinator would be beneficial to ensure that asylum seekers have access to services and benefits at multiple levels of government; now, therefore, be it

**Resolved**, That the Council of the City of New York calls on the New York State Legislature to pass, and the Governor to sign, A.7493, establishing a coordinator for asylum seeker services.

Referred to the Committee on Immigration.

## Res. No. 851

**Resolution calling on the Federal Election Commission to prohibit political candidates from using deceptive artificial intelligence in campaign communications.**

By Council Members Menin, Ung, Hanif, Hudson and Gutiérrez.

**Whereas**, Fake pictures and videos are not new to political advertising; and

**Whereas**, Political campaigns increasingly rely on digital media to reach voters; and

**Whereas**, Advances in artificial intelligence allow campaigns to create ads and other types of campaign communications with fake images that are indistinguishable from real videos or photographs; and

**Whereas**, Recent advances in artificial intelligence make it easier and cheaper for campaigns to generate false pictures and videos; and

**Whereas**, Political campaigns have already started using artificial intelligence to create “deep fake” videos showing candidates saying or doing things that they never said or did; and

**Whereas**, Deceptive images or videos created by artificial intelligence can be used to spread misinformation; and

**Whereas**, Facebook, Instagram, and Google have recently adopted rules that require political ads to disclose when they use artificial intelligence; and

**Whereas**, The regulation of political advertisement should not be left up to private companies that directly profit from the same political advertising they are being asked to regulate; and

**Whereas**, There are currently no laws that specifically prohibit or limit the use of artificial intelligence in political ads; and

**Whereas**, Federal law prohibits candidates for federal offices from fraudulently misrepresenting themselves as speaking for another candidate or political party on a matter which is damaging to that candidate or party; and

**Whereas**, According to Public Citizen the Federal Elections Commission has the authority to regulate artificial intelligence in political campaigns under its authority to regulate fraudulent misrepresentations; now, therefore, be it

**Resolved**, That the Council of the City of New York calls on the Federal Election Commission to prohibit political candidates from using deceptive artificial intelligence in campaign communications.

Referred to the Committee on Governmental Operations.

## Int. No. 1265

By Council Members Narcisse and Louis.

**A Local Law to amend the administrative code of the city of New York, in relation to establishing a mandatory mental health emergency response training for all uniformed members of the police department whose responsibilities include routinely interacting with arrested individuals and victims of crime**

*Be it enacted by the Council as follows:*

Section 1. Chapter 1 of title 14 of the administrative code of the city of New York is amended by adding a new section 14-194 to read as follows:

*§ 14-194 Mental health emergency response training. The commissioner, in collaboration with the commissioner of health and mental hygiene, shall create and implement a mandatory training for all uniformed members of the department whose responsibilities include routinely interacting with arrested individuals and victims of crime on recognizing and responding to mental health emergencies. Such members of the department shall complete such training within 1 year of the effective date of the local law that added this section and once every 2 years thereafter. The training shall provide information on:*

1. *The ways that symptoms of different mental illnesses can cause a mental health emergency;*
2. *How to effectively communicate with a person experiencing a mental health emergency;*
3. *How to deescalate a situation in which a person is experiencing a mental health emergency; and*
4. *Alternatives to involuntary removal, including offering to bring the person experiencing a mental health emergency to a hospital or other facility where medical care is provided or to a crisis respite center or clubhouse where non-coercive community based care is provided, and providing information about resources, including addresses and phone numbers, to enable the person experiencing the mental health emergency to access care independently.*

§ 2. This local law takes effect 120 days after it becomes law.

Referred to the Committee on Public Safety.

Int. No. 1266

By Council Member Paladino.

**A Local Law to amend the administrative code of the city of New York, in relation to temporarily exempting certain covered buildings from building emissions limits and studying the impact of such limits on such buildings and on the electrical distribution grid**

*Be it enacted by the Council as follows:*

Section 1. Chapter 3 of title 28 of the administrative code of the city of New York is amended by adding a new section 28-320.12 to read as follows:

**28-320.12 Temporary exemption for certain covered buildings.** *For calendar years 2024 and 2025, covered buildings held in the condominium or cooperative form of ownership and covered buildings containing dwelling units offered for rent are exempt from the annual building emissions limits set forth in section 28-320.3.1 and from any applicable reporting requirements in connection with such limits. Commencing January 1, 2026, such covered buildings shall be subject to the annual building emission limits set forth in section 28-320.3.1 and any applicable reporting requirements in connection with such limits.*

§ 2. Financial impact study relating to building emissions limits. a. For purposes of this section, the following terms have the following meanings:

Building emissions limits. The term “building emissions limits” means the building emissions limits established under sections 28-320.3.1 and 28-320.3.2 of the administrative code.

Administrative code. The term “administrative code” means the administrative code of the city of New York.

Covered building. The term “covered building” has the same meaning as set forth in section 28-320.1 of the administrative code.

Dwelling unit. The term “dwelling unit” has the same meaning as set forth in the housing maintenance code of the city of New York.

b. The head of an office or agency designated by the mayor, in collaboration with the director of the office of building energy and emissions performance, shall study and report on the financial impact of building emissions limits on covered buildings held in the condominium or cooperative form of ownership and on covered buildings containing dwelling units offered for rent that are not held in such forms of ownership, taking into account the temporary exemption from such limits set forth in section 28-320.12 of the administrative code. No later than 1 year after the effective date of this local law, such office or agency head and such director shall submit to the speaker of the council and the mayor, and publish on the city’s website, a joint report on the findings of such study. Such report shall include, but need not be limited to, the following information:

1. An estimate of the total and per-building average expenditures that need to be made for compliance with building emissions limits by owners of covered buildings held in the condominium form of ownership and by owners of covered buildings held in the cooperative form of ownership;
2. An estimate of the total and per-building average expenditures that need to be made for compliance with such limits by owners of covered buildings containing dwelling units offered for rent that are not held in the cooperative or condominium form of ownership;
3. An estimate of the total and per-building average amount of civil penalties to be paid under section 28-320.6 of the administrative code for failure to comply with such limits by owners of covered buildings held in the condominium form of ownership and by owners of covered buildings held in the cooperative form of ownership;
4. An estimate of the total amount of civil penalties to be paid under section 28-320.6 of the administrative code for failure to comply with such limits by all owners of covered buildings containing dwelling units offered for rent that are not held in the condominium or cooperative form of ownership;
5. Estimates, expressed as percentages, of the average effect of such limits on the property values of covered buildings held in the condominium form of ownership;
6. Estimates, expressed as percentages, of the average effect of such limits on the property values of covered buildings held in the cooperative form of ownership; and
7. Estimates of rent increases at covered buildings containing dwelling units offered for rent that are not held in the condominium or cooperative form of ownership, caused by owners of such buildings seeking to recoup costs imposed by such limits.

§ 3. Study relating to the electrical distribution grid. a. The office of long-term planning and sustainability, in consultation with other relevant agencies or offices of the city and with experts in the operation of electrical distribution grids, shall conduct a study regarding the reliability and resiliency of the city's electrical distribution grid, and transmission lines into the city, in relation to any potential increase in the use of such grid due to efforts to comply with the building emissions limits established under sections 28-320.3.1, 28-320.3.2, and 28-320.3.4 of the administrative code of the city of New York.

b. No later than 1 year after the effective date of this local law, the office of long-term planning and sustainability shall submit to the speaker of the council and the mayor, and publish on the city's website, a report detailing the findings of the study conducted pursuant to this section.

§ 4. This local law takes effect immediately.

Referred to the Committee on Housing and Buildings.

Int. No. 1267

By Council Members Paladino, Holden, Ariola and Kagan.

**A Local Law to amend the administrative code of the city of New York, in relation to prohibiting the operation of electric scooters and bicycles with electric assist in parks**

*Be it enacted by the Council as follows:*

Section 1. Section 19-176.2 of the administrative code of the city of New York, as amended by local laws number 72 and 73 for the year 2020, is amended by adding a new subdivision f to read as follows:

*f. Operation of an electric scooter, as defined in section 114-e of the vehicle and traffic law, and operation of a bicycle with electric assist, as defined in section 102-c of the vehicle and traffic law, shall be prohibited in any area of any park under the jurisdiction of the department of parks and recreation.*

§ 2. This local law takes effect immediately.

Referred to the Committee on Transportation and Infrastructure.

Res. No. 852

**Resolution calling on the State Legislature to pass, and the Governor to sign S7737/A8261, also known as The Hate Crimes Modernization Act.**

By Council Members Powers and Dinowitz (by request of the Manhattan Borough President).

**Whereas**, Hate crimes have significantly increased in New York City as indicated by a 55.8% increase in reported hate crimes in 2021, adversely affecting the safety and well-being of our diverse communities; and

**Whereas**, New York State hate crimes law limits the prosecution of crimes as bias-related incidents, leaving out crucial charges such as Gang Assault, Making Graffiti, Sex Trafficking, Labor Trafficking, False Reporting, Criminal Possession of a Weapon, and certain sex crimes from the list of crimes eligible for consideration; and

**Whereas**, As a result, the current New York State hate crimes law fails to adequately encompass certain acts perceived by many as potential hate crimes, creating a disparity between public perception and legal classification; and

**Whereas**, S7737/A8261, The Hate Crimes Modernization Act, sponsored by State Senator Brad Hoylman-Sigal and State Assemblymember Grace Lee, aims to address these disparities by expanding the list of potential crimes eligible to be considered biased related hate crime charges from 66 to 97; and

**Whereas**, The Hate Crimes Modernization Act enhances the definition of hate crimes, incorporating offenses such as gang assault, specific sex crimes, human trafficking, graffiti, false reporting, and weapon possession; and

**Whereas**, The expanded definition of hate crimes offers prosecutors the tools needed to combat and prosecute a broader range of bias-motivated cases; and

**Whereas**, The New York City Council recognizes the urgency of updating New York State's hate crimes laws to ensure greater accountability, protect vulnerable communities, and send a strong message that hatred and discrimination will not be tolerated; now, therefore, be it

**Resolved**, That the Council of the City of New York calls on the State Legislature to pass, and the Governor to sign S7737/A8261, also known as The Hate Crimes Modernization Act.

Referred to the Committee on Public Safety.

Int. No. 1268

By the Public Advocate (Mr. Williams) and Council Members Louis, Sanchez, Hanif, Menin, Won, Marte, Farías, De La Rosa, Krishnan, Ayala, Ossé, Cabán, Nurse, Restler, Gutiérrez, Avilés and Hudson.

**A Local Law to amend the New York city charter, in relation to creating a division within the department of small business services to assist street vendors and requiring the commissioner of small business services to update the department's programs to facilitate street vendor access**

*Be it enacted by the Council as follows:*

Section 1. Chapter 56 of the New York city charter is amended by adding a new section 1309.1 to read as follows:

*§ 1309.1. Division of street vendor assistance. a. Definitions. For purposes of this section, the following terms have the following meanings:*

*Food vendor. The term "food vendor" has the same meaning as set forth in section 17-306 of the administrative code.*

*General vendor. The term "general vendor" has the same meaning as set forth in section 20-452 of the administrative code.*

*b. Responsibilities of the division. 1. There shall be a division of street vendor assistance within the department. Such division shall:*

*(a) Serve as a clearinghouse for the provision of services and resources relating to business and economic development to food vendors and general vendors;*

*(b) Publish on the department's website a list of such services and resources that food vendors and general vendors may utilize;*

*(c) Assist food vendors and general vendors in applying for and accessing the department's programs;*

*(d) Collaborate with the office of street vendor enforcement to offer training and education and conduct outreach in the designated citywide languages, as such term is defined in section 23-1101, to all food vendors and general vendors on entrepreneurship and compliance with all applicable local laws, rules, and regulations, including but not limited to such laws, rules, and regulations concerning legal vending locations and time, place, and manner restrictions applicable to vending;*

*(e) Create business development programs specific to food vendors and general vendors;*

*(f) Review all department programs and recommend to the commissioner which such programs food vendors and general vendors should be permitted to access; and*

*(g) Review all department programs and recommend to the commissioner any administrative requirements for such programs that should be removed or adjusted to facilitate access for food vendor and general vendor applicants.*

*2. The division shall offer training and education and conduct outreach required under subparagraph (d) of paragraph 1 of this subdivision on a monthly basis. The division shall focus the outreach required under such subparagraph in areas that have a high density of food vendors or general vendors and in any areas identified by the office of street vendor enforcement as featuring a high level of complaints about food vendor or general vendor activity.*

*c. Responsibilities of the commissioner. 1. The commissioner shall update department programs to permit access to food vendors and general vendors based on recommendations made by the division of street vendor assistance pursuant to subparagraph (f) of paragraph 1 of subdivision b of this section, subject to the purposes of such programs as determined by the commissioner and unless otherwise prohibited by law.*

*2. The commissioner shall update department programs to remove or adjust administrative requirements for such programs based on recommendations made by the division of street vendor assistance pursuant to subparagraph (g) of paragraph 1 of subdivision b of this section, subject to, as determined by the commissioner, the purposes of such programs and the role of such requirements in preventing fraud, and unless otherwise prohibited by law.*

*d. Reporting. 1. No later than 180 days after the effective date of the local law that added this section and annually thereafter, the commissioner shall submit to the speaker of the council and to the mayor, and the commissioner shall publish on the department's website, a report outlining the commissioner's reasons for the exclusion of food vendors and general vendors from any department programs and for the commissioner's removal or adjustment of any administrative requirements for department programs pursuant to paragraph 2 of subdivision c of this section.*

*2. No later than 180 days after the effective date of the local law that added this section and annually thereafter, the commissioner shall submit to the speaker of the council and to the mayor, and the commissioner shall publish on the department's website, a report on (i) the number of food vendors and general vendors to which the division of street vendor assistance provided assistance during the previous year, and (ii) the types of assistance provided to food vendors and general vendors by such division during the previous year, disaggregated by percentage.*

*§ 2. This local law takes effect 120 days after it becomes law.*

Referred to the Committee on Small Business.

## Int. No. 1269

By Council Members Riley, Farías, Louis, Hanif, Hudson, Restler and Gutiérrez.

**A Local Law to amend the administrative code of the city of New York, in relation to requiring the department of health and mental hygiene to create pamphlets identifying mental health resources available to individuals experiencing pregnancy loss**

*Be it enacted by the Council as follows:*

Section 1. Section 17-199.21 of the administrative code of the city of New York, as added by local law number 108 for the year 2023, is redesignated section 17-199.24.

§ 2. Chapter 1 of title 17 of the administrative code of the city of New York is amended by adding a new section 17-199.24.1 to read as follows:

§ 17-199.24.1 *Mental health resource pamphlets for individuals experiencing pregnancy loss. a. Definitions. For purposes of this section, the following terms have the following meanings:*

*Designated citywide languages. The term “designated citywide languages” has the same meaning as set forth in subdivision a of section 23-1101.*

*Pregnancy loss. The term “pregnancy loss” means the loss of a fetus by miscarriage, stillbirth, termination, or other reason.*

*b. The commissioner shall create pamphlets that contain information about the possible effects of pregnancy loss on mental health and identify mental health resources available to individuals who have experienced pregnancy loss. Such pamphlets shall be made available in the designated citywide languages and reviewed and updated regularly as appropriate. Each pamphlet shall address a single type of pregnancy loss, including but not necessarily limited to miscarriage, stillbirth, or termination, and specific information and resources related to such type of loss. The commissioner shall provide such pamphlets to all facilities operated by the department or a provider under contract with the department and that provide reproductive healthcare, and shall make available such pamphlets to all reproductive healthcare providers in the city, for distribution to individuals who may benefit from such pamphlets. The commissioner shall post such pamphlets on the department’s website.*

§ 3. This local law takes effect 180 days after it becomes law.

Referred to the Committee on Mental Health, Disabilities and Addiction.

## Int. No. 1270

By Council Members Sanchez, Farías, De La Rosa, Krishnan, Hanif, Ayala, Ossé, Cabán, Nurse, Marte, Restler, Gutiérrez, Won, Avilés, Hudson, Louis and the Public Advocate (Mr. Williams).

**A Local Law to amend the administrative code of the city of New York, in relation to ensuring business licensing and regulatory compliance of all mobile food and general vendors.**

*Be it enacted by the Council as follows:*

Section 1. Subparagraph a of paragraph 3 of subdivision b of section 17-307 of the administrative code of the city of New York, as amended by local law number 18 for the year 2021, is amended to read as follows:

(a) (i) Notwithstanding the provisions of paragraph two of this subdivision limiting the number of full-term permits that are authorized to be issued, the commissioner may issue up to a maximum of 100 additional full-term permits authorizing the holders thereof to vend food from any vehicle or pushcart in any public place in the city of New York where food vendors are not prohibited from vending. Such permits shall be issued only to natural persons.

(ii) The department shall make available for application [45] 90 supervisory licenses per twelve-month period for [ten] five consecutive years beginning on [July 1, 2022] July 1, 2024. In addition to the 100 permits



authorized to be issued by clause (i) of this subparagraph, and notwithstanding the provisions of paragraph two of this subdivision limiting the number of full-term permits authorized to be issued, the department shall make available for application to applicants who comply with the requirements for such supervisory licenses an additional [45] 90 permits per twelve-month period for [ten] five consecutive years beginning on [July 1, 2022] July 1, 2024 and issue a permit to each applicant who complies with the requirements for such permit.

(iii) Supervisory licenses available pursuant to this paragraph shall be made available for application in accordance with the preferences specified in subparagraph (b) of this paragraph and the procedures established by the commissioner.

§ 2. Paragraph 5 of subdivision b of section 17-307 of the administrative code of the city of New York, as amended by local law number 18 for the year 2021, is amended to read as follows:

5. (a) On or after July 1, 2022 all new permits issued under this subchapter, except fresh fruits and vegetables permits, shall be designated for use only when any holder of a supervisory license is physically present and vending. Such requirement shall not apply to a permit issued before July 1, 2022 or a renewal thereof until [July 1, 2032] July 1, 2029. On or after [July 1, 2032] July 1, 2029, all permits issued under this subchapter, except fresh fruits and vegetables permits, shall be designated for use only when any holder of a supervisory license is physically present and vending.

(b) The commissioner shall make available for application [400] 1,500 supervisory licenses per twelve-month period for [ten] five consecutive years beginning on [July 1, 2022] July 1, 2024. Notwithstanding the provisions of this subdivision limiting the total number of full-term permits that are authorized to be issued, the commissioner shall make available a permit application to each license applicant who complies with the requirements for such supervisory license and issue a permit to each permit applicant who complies with the requirements for such permit. On or before [July 1, 2032] July 1, 2029, the commissioner shall make available for application supervisory licenses to any person seeking to renew a permit that was issued under this subchapter before July 1, 2022.

(c) In accordance with procedures to be established by rules of the commissioner, in each twelve month period, [100] 375 of the supervisory licenses made available for application under this paragraph shall be designated for use in any borough, and the remaining [300] 1,125 such supervisory licenses shall be designated for use in boroughs outside of Manhattan.

(d) Preferences shall be given in the availability of applications for supervisory licenses pursuant to this paragraph and in the placement on a waiting list therefor to the following categories of persons in the following order.

(i) Persons who have held a food vendor license continuously since on or before March 1, 2017 and have been on a waiting list for a full-term permit pursuant to subparagraph (e) of paragraph 2 of this subdivision and remain on such list as of the date an application is made available. Applications shall be made available to such persons by order of numerical rank on the waiting list.

(ii) Persons who have been on a waiting list for a full-term permit pursuant to this subchapter and remain on such list as of the date an application is made available but have not held a food vendor license continuously since on or before March 1, 2017. Applications shall be made available to such persons by order of numerical rank on the waiting list.

(iii) Persons who have held a food vendor license continuously since on or before March 1, 2017 but are were not on a waiting list for a full-term permit pursuant to this subchapter as of the effective date of the local law that added this paragraph.

(iv) Persons who have not held a food vendor license continuously since on or before March 1, 2017 and were not on a waiting list for a full-term permit pursuant to this subchapter as of the effective date of the local law that added this paragraph.

(e) The commissioner may by rule limit the number of places on such waiting list, but shall ensure that such waiting list is operative prior to supervisory licenses becoming available to new individuals.

(f) *On or by July 1, 2029, an unlimited number of supervisory licenses shall be made available for application in accordance with the provisions of this subchapter.*

§ 3. Subdivision h of section 17-307 of the administrative code of the city of New York, as added by local law number 18 for the year 2021, is amended to read as follows:

h. No permit or license, including a supervisory license, shall be issued to a person required to have a permit or license pursuant to this subchapter unless such person obtains a certificate issued by the department subsequent to successful completion of a training developed or approved by the department on the vending restrictions contained in this section and any other information the department deems necessary to the safe operation of such vending unit, and passage of an examination administered by the department. *Such training shall include information related to the particular vending restrictions of the prospective license holder.* The department shall require renewal of such certificate every four years. Renewal shall be contingent on passing an examination regarding the vending restrictions contained in this section and any other information the department deems necessary to the safe operation of such vending unit pursuant to rules promulgated by the department. Any examinations, or educational materials designed for such training program shall be made available in English and in the ten most common languages spoken by limited English proficient individuals in the city according to the department of city planning. Such educational materials shall be available on the department's website.

§ 4. Subdivision a of section 20-459 of the administrative code of the city of New York is amended to read as follows:

a. The number of licenses in effect pursuant to this subchapter on the first day of September, nineteen hundred seventy-nine shall be the [maximum] *minimum* number of licenses permitted to be in effect.

§ 5. Section 20-459 of the administrative code of the city of New York is amended by adding a new subdivision c to read as follows:

c. *The commissioner shall make available for application 1,500 additional licenses per twelve-month period for five consecutive years beginning on July 1, 2024. On or by July 1, 2029, an unlimited number of licenses shall be made available for application in accordance with the provisions of this subchapter.*

§ 6. This local law takes effect immediately.

Referred to the Committee on Consumer and Worker Protection.

Int. No. 1271

By Council Member Ung.

**A Local Law to amend the administrative code of the city of New York, in relation to banning the use of commercial char broilers on or in connection with mobile food vending units**

*Be it enacted by the Council as follows:*

Section 1. Subchapter 6 of chapter 1 of title 24 of the administrative code of the city of New York is amended by adding a new section 24-149.7 to read as follows:

§ 24-149.7 *Commercial charbroiling on or in connection with mobile food vending units. a. Prohibition. No person shall operate a commercial char broiler on or in connection with a mobile food vending unit.*

*b. Enforcement. 1. A person who violates subdivision a of this section or any rule promulgated thereunder is liable for civil penalties as prescribed by section 24-178 and any rules promulgated thereunder.*

*2. For a subsequent violation of subdivision a of this section committed after the date of a first violation of such subdivision, the commissioner may seize and impound the commercial char broiler. Where such char broiler cannot be detached from a mobile food vending unit, the commissioner may seize and hold the entire mobile food vending unit.*

*3. A party affected by a seizure pursuant to this subdivision is entitled to a hearing within 10 days after such seizure, in accordance with the rules of the board. Such a party may obtain an expedited hearing by submitting written notice to the board, in which case the board shall hold such expedited hearing within 24 hours of service of such request, in accordance with the rules of the board. The board shall issue a final decision and order thereon within 3 days after the conclusion of a hearing or expedited hearing held pursuant to this paragraph.*

§ 2. The table of civil penalties in subparagraph (i) of paragraph (3) of subdivision (a) of section 24-178 of the administrative code of the city of New York is amended by adding a new row in numerical order to read as follows:

24-149.7	400	1600
----------	-----	------

§ 3. This local law takes effect 1 year after it becomes law.

Referred to the Committee on Environmental Protection, Resiliency and Waterfronts.

Int. No. 1272

By Council Member Ung.

**A Local Law to amend the administrative code of the city of New York, in relation to department of transportation approval prior to issuing or renewing a stoop line stand license**

*Be it enacted by the Council as follows:*

Section 1. Section 20-239 of the administrative code of the city of New York, as amended by local law number 5 for the year 2013, is amended to read as follows:

§ 20-239 Approval. [A] *a. The commissioner shall not issue or renew a license for a stoop line stand [shall not be licensed] unless the location thereof has been approved in writing by the department of transportation. [No license shall be approved or renewed if the] The department of transportation shall not approve the location of a stoop line stand if it determines that the stoop line stand poses an obstruction to the free use of sidewalks by pedestrians. In making such determination, the department of transportation shall consider the area’s pedestrian volume, the site visit described in subdivision b of this section where applicable, and any other factors the department of transportation deems relevant.*

*b. If the location of a proposed or existing stoop line stand is within 10 feet of a permanent structure that narrows the clear path of the sidewalk for a length of 10 feet or more, the department of transportation shall conduct a site visit to assess the stoop line stand’s impact on the free use of sidewalks by pedestrians prior to issuing the approval required pursuant to subdivision a of this section.*

*c. Notwithstanding anything in this subchapter to the contrary, if the department of transportation determines that a stoop line stand which is permitted to extend more than [four] 4 feet in width pursuant to section 20-237 of this subchapter poses an obstruction to the free use of sidewalks by pedestrians solely because the width of such stoop line stand exceeds [four] 4 feet, the commissioner shall approve or renew such license at a width of [four] 4 feet.*

§ 2. This local law takes effect 60 days after it becomes law.

Referred to the Committee on Transportation and Infrastructure.

Res. No. 853

**Resolution calling on the New York State legislature to pass, and the Governor to sign, A.5554, which would prohibit use of single-use plastics in state parks, A.6990/S.2981, which would prohibit the sale or manufacture of certain single-use plastic water bottles and single-use plastic beverage containers, and S.7345, which would enact the NY Plastic Free Act.**

By Council Members Velázquez, Hanif and Gutiérrez.

**Whereas**, Plastics are in products used in daily life ranging from bicycle safety helmets, cellphones, and food storage containers; and

**Whereas**, Over the last 70 years, plastic production has increased dramatically with over 390 million tons produced in 2021, as opposed to 2 million tons produced in 1950; and

**Whereas**, Single-use plastics are a class of products that are designed to be discarded immediately after use, including items such as plastic straws, cutlery, disposable cups and plates, food containers, shopping bags, and packaging materials; and

**Whereas**, While some single-use plastics serve vital purposes, such as surgical gloves, packaging that helps keep surgical tools and medical supplies sterile, and straws for people with disabilities, these uses represent a small fraction of the single-use plastics that are manufactured every year; and

**Whereas**, Approximately 8 million tons of plastic waste enters the oceans from coastal nations each year, making it difficult to remove plastic waste and keep the oceans clean and safe for wildlife; and

**Whereas**, Plastics harm wildlife, killing millions of animals every year as a result of entanglement, or through starvation from blocking digestive tracts in animals such as seals, whales, turtles, and birds after accidental consumption; and

**Whereas**, Plastics contain additives to make them strong and durable, extending the life of these products when they become litter, and taking an estimated 400 years to break down; and

**Whereas**, Currently, single-use plastics account for 40 percent of the plastic produced each year, a figure that is expected to continue increasing, affecting the environment and, more importantly, overwhelming the world's ability to deal with their disposal; and

**Whereas**, A.5554, sponsored by New York State Assemblymember Keith P. Brown, currently pending in the New York State Assembly, seeks to prohibit the sale of single-use plastic and polystyrene foam in state parks in order to reduce use of single-use plastics in New York State; and

**Whereas**, A.6990, sponsored by New York State Assemblymember Patricia Fahy, currently pending in the New York State Assembly, and companion bill S.2981, sponsored by New York State Senator Brian Kavanagh, currently pending in the New York State Senate, seeks to prohibit the sale or manufacture of single-use plastic water bottles not comprised of 100 percent recycled material, prohibit the sale of single-use plastic beverage containers comprised of less than 75 percent recycled materials, establishes penalties for violations, and requires food service establishments to provide customers with tap water, beverages, and leftovers in reusable beverage containers provided by a customer; and

**Whereas**, S.7345, sponsored by New York State Senator Kevin S. Parker, currently pending in the New York State Senate, known as the NY Plastic Free Act, seeks to prohibit the sale or distribution of single-use plastic products in New York State while providing exceptions for people with medical conditions and single-use plastic bags for garbage collection; and

**Whereas**, A.5554, A.6990/S.2981, and S.7345 would ensure that New York State would reduce the use of single-use plastics by the public, government, and manufacturers to try to decrease plastic waste and improve waste management systems and recycling; now, therefore, be it

**Resolved**, That the Council of the City of New York calls on the New York State legislature to pass, and the Governor to sign, A.5554, which would prohibit use of single-use plastics in state parks, A.6990/S.2981, which would prohibit the sale or manufacture of certain single-use plastic water bottles and single-use plastic beverage containers, and S.7345, which would enact the NY Plastic Free Act.

Referred to the Committee on Sanitation and Solid Waste Management.

Int. No. 1273

By Council Members Vernikov, Holden, Carr and Paladino.

**A Local Law to amend the administrative code of the city of New York, in relation to the creation of a public database to track the expenditure of funds in connection with increased migrant arrivals**

*Be it enacted by the Council as follows:*

Section 1. Chapter 1 of title 6 of the administrative code of the city of New York is amended by adding a new section 6-148 to read as follows:

*§ 6-148 Migrant arrival funding database. a. Definitions. For purposes of this chapter, the following terms have the following meanings:*

*Emergency. The term “emergency” means the local state of emergency declared by the mayor on October 7, 2022 in emergency executive order No. 224, or any executive order renewing or extending such emergency.*

*Emergency funds. The term “emergency funds” means any funds distributed in relation to the emergency, including, but not limited to funds used for construction, housing, shelter, food, water, healthcare, mental health counseling, legal representation, transportation, job placement, and job training.*

*Recipient. The term “recipient” means any agency, person, or entity, including any individual, sole proprietorship, partnership, association, joint venture, limited liability company, corporation, or any other form of business, awarded funds for the purposes of addressing the emergency.*

*b. The comptroller shall establish and maintain an interactive database to be published on a publicly accessible webpage. The interactive database shall include summaries of the disbursement of emergency funds. The data included in such database shall be available in a format that permits automated processing and shall be available without any registration requirement, license requirement, or restrictions on their use, provided that the city may require a third party providing to the public any data from such database, or any application utilizing such data, to explicitly identify the source and version of the data, and a description of any modifications made to such data. The comptroller shall provide the following information on a quarterly basis, disaggregated by contract type:*

*1. For each construction project, including emergency shelter construction, the name of the contractor, and subcontractor, if known, and a detailed description of the project, including, but not limited to:*

- (a) physical address;*
- (b) block and lot numbers, if applicable;*
- (c) estimated dates of start and completion;*
- (d) purpose of the project in relation to the emergency;*
- (e) the value and type of funding provided, including but not limited to grants, loans; contracts, or other such forms of financial assistance; and*
- (f) the total number of additional jobs to be created and retained over the life of the construction project.*

*2. For each executed city procurement contract associated with emergency funds:*

- (a) the name of the contract vendor;*
- (b) contract identification number;*
- (c) purpose of the contract;*
- (d) original contract value in dollars;*
- (e) revised contract value in dollars, if applicable;*
- (f) whether the contract was awarded subject to public bidding;*
- (g) original contract start and end date;*
- (h) revised contract end date, if applicable;*
- (i) contract status;*
- (j) information on the contract recipient’s qualification for receipt of emergency funds; and*
- (k) the total number and description of the jobs expected to be created and retained over the life of the contract.*

*3. For each local, state, or federal grant or loan issuance providing emergency funds:*

- (a) the recipient name;*
- (b) the purpose of the grant or loan;*
- (c) the grant or loan award amount;*
- (d) whether the grant or loan was subject to a selective award process and the nature of that process;*
- (e) grant or loan name;*
- (f) award status;*
- (g) information on the grant or loan recipient’s qualification for receipt of emergency funds; and*

*(h) the total number and description of the jobs expected to be created and retained over the life of the project, if applicable.*

*4. The total number of migrants served using emergency funds.*

*c. The webpage required pursuant to this section shall not be used to distribute information which, if disclosed, would jeopardize compliance with local, state, or federal law; threaten public health, welfare, or safety; harm the competitive economic position of a party; or harm a migrant.*

*d. The comptroller shall continue to provide such data on a quarterly basis for the duration of the emergency.*

*e. This section shall not be construed to create a private right of action to enforce its provisions. Failure to comply with this section shall not result in liability for the city. The city shall not be deemed to warranty the completeness, accuracy, content or fitness for any particular purpose or use of any information provided by the city pursuant to this section, including information provided to the city by a third party or information provided by the city that is based upon information provided by a third party.*

§ 2. This local law takes effect immediately.

Referred to the Committee on Contracts.

Int. No. 1274

By Council Member Yeger.

**A Local Law to amend the administrative code of the city of New York, in relation to expanding notice requirements and requiring a comment period prior to the installation of a neighborhood loading zone**

*Be it enacted by the Council as follows:*

Section 1. Subdivision a of section 19-170.2 of the administrative code of the city of New York is amended by adding a new definition of “neighborhood loading zone” in alphabetical order to read as follows:

*Neighborhood loading zone. The term “neighborhood loading zone” means a loading zone on a residential street, as such term is defined in subdivision b of section 19-170, specifically designated as a neighborhood loading zone by department signage.*

§ 2. Subdivision d of section 19-170.2 of the administrative code of the city of New York, as added by local law number 168 for the year 2021, is amended to read as follows:

*d. 1. No later than January 1, 2023, the department shall provide publicly accessible information, through the open data portal or the department’s website, regarding the location of all loading zones. Such information shall be updated on an annual or more frequent basis.*

*2. The department shall publish the location of any newly installed neighborhood loading zone through the open data portal or on the department’s website no later than 5 days after the department installs the neighborhood loading zone.*

§ 3. Section 19-170.2 of the administrative code of the city of New York is amended by adding new subdivisions e and f to read as follows:

*e. 1. At least 90 days before the installation of a neighborhood loading zone, and in addition to any notice required pursuant to section 19-175.2 or any other provision of law or rules, the department shall provide notice of installation of the neighborhood loading zone to the council member and community board in whose district the neighborhood loading zone is to be installed. Such notice shall include but not be limited to details regarding the proposed location of the neighborhood loading zone, the anticipated date of installation of the neighborhood loading zone, and a method to participate in the comment period required by subdivision f of this section. The department shall also provide such notice to any property owners, community-based organizations, and members of the general public that have formally requested to be notified of installation of a neighborhood loading zone and to other individuals or organizations that the department deems appropriate.*

2. *At least 90 days before the installation of a neighborhood loading zone, and in addition to any notice required pursuant to section 19-175.2 or any other provision of law or rules, the department shall post in conspicuous locations at least 4 physical notices of installation of the neighborhood loading zone, including but not limited to details regarding the proposed location of the neighborhood loading zone, the anticipated date of installation of the neighborhood loading zone, and a method to participate in the comment period required by subdivision f of this section, on each of the following blockfaces, as such term is defined in section 19-167:*

- (a) The blockface on which the neighborhood loading zone is to be installed;*
- (b) The blockface opposite the one on which the neighborhood loading zone is to be installed;*
- (c) Each blockface that is directly adjacent to the blockface on which the neighborhood loading zone is to be installed; and*
- (d) Each blockface that is directly adjacent to the blockface opposite the one on which the neighborhood loading zone is to be installed.*

*f. Beginning at least 60 days but not more than 75 days before the installation of a neighborhood loading zone, the department shall afford the public 30 days to submit comments to the department on the installation of the neighborhood loading zone. The department shall consider the comments, if any, submitted pursuant to this subdivision and may incorporate corresponding changes into its plan for installation of the neighborhood loading zone.*

§ 4. This local law takes effect 60 days after it becomes law.

Referred to the Committee on Transportation and Infrastructure.

Preconsidered L.U. No. 288

By Council Member Brannan:

**1601 DeKalb, Block 3237, Lot 23, Brooklyn, Community District 4, Council District No. 37.**

Adopted by the Council (preconsidered and approved by the Committee on Finance).

Preconsidered L.U. No. 289

By Council Member Brannan:

**Sumet I, Block 2407, Lots 12, 14, 15, and 17; Block 2408, Lots 7, 12, 14, 37, 38, and 40; Block 2420, Lots 5 and 43, Brooklyn, Community District 1, Council District No. 34.**

Adopted by the Council (preconsidered and approved by the Committee on Finance).

Preconsidered L.U. No. 290

By Council Member Brannan:

**MHANY Stella Heights LLC.PLP.FY24, Block 2114, Lot 70; Block 2132, Lot 30, Manhattan, Community District 12, Council Districts No. 7 and 10.**

Adopted by the Council (preconsidered and approved by the Committee on Finance).

Preconsidered L.U. No. 291

By Council Member Brannan:

**Villa Hermosa, Block 1613, Lot 6, Manhattan, Community District 11, Council District No. 9.**

Adopted by the Council (preconsidered and approved by the Committee on Finance).

Preconsidered L.U. No. 292

By Council Member Salamanca:

**Application number G 230040 XAK (New Penn Article XI) submitted by the New York City Department of Housing Preservation and Development, pursuant to Section 577 of Article XI of the Private Housing Finance Law for the approval of an exemption from real property taxation for property located at Block 3583, Lot 27; Block 3602, Lot 44; Block 3754, Lot 31; Block 3767, Lot 5; Block 3773, Lot 56; Block 3774, Lot 138; Block 3790, Lot 49; Block 3791, Lot 25 and 28; Block 3833, Lot 47, Borough of Brooklyn, Community Districts 5 and 16, Council District 42.**

Referred to the Committee on Land Use and the Subcommittee on Landmarks, Public Sitings and Dispositions (preconsidered and approved by the Subcommittee on Landmarks, Public Sitings and Dispositions).

Preconsidered L.U. No. 293

By Council Member Salamanca:

**Application number G 230039 XAM (West 120-126<sup>th</sup> Street Cluster) submitted by the New York City Department of Housing Preservation and Development (HPD), pursuant to Article 16 of the General Municipal Law and Article XI of the Private Housing Finance Law, requesting approval of an Urban Development Action Area Project, waiver of the designation requirement of Section 693 of the General Municipal Law and waiver of the requirements of Charter Sections 197-c and 197-d, and approval of an exemption from real property taxation for properties located at 150 West 121<sup>st</sup> Street (Block 1905, Lot 155), 204 West 120<sup>th</sup> Street (Block 1925, Lot 38), 271 West 126<sup>th</sup> Street (Block 1932, Lot 1), and 305 West 126<sup>th</sup> Street (Block 1953, Lot 27), Borough of Manhattan, Community District 10, Council District 9.**

Referred to the Committee on Land Use and the Subcommittee on Landmarks, Public Sitings and Dispositions (preconsidered but laid over by the Subcommittee on Landmarks, Public Sitings and Dispositions).

Preconsidered L.U. No. 294

By Council Member Salamanca:

**Application number G 230041 SCK (New 676-Seat High School Facility) submitted by the New York City School Construction Authority, pursuant to Section 1732 of the New York School Construction Authority Act, concerning the proposed site selection for a new, approximately 676-Seat High School facility including D75 Special Education, located at Block 5873, Lots 73 and 77, Borough of Brooklyn, Community District 10, Council District 43, Community School District 20.**

Referred to the Committee on Land Use and the Subcommittee on Landmarks, Public Sitings and Dispositions (preconsidered but laid over by the Subcommittee on Landmarks, Public Sitings and Dispositions).



## Preconsidered L.U. No. 295

By Council Member Salamanca:

**Application number G 230042 SCQ (New 696-Seat Primary School Facility) submitted by the New York City School Construction Authority, pursuant to Section 1732 of the New York School Construction Authority Act, concerning the proposed site selection for a new, approximately 696-Seat Primary School facility, located at Block 5145, Lot 90, Borough of Queens, Community District 7, Council District 20, Community School District 25.**

Referred to the Committee on Land Use and the Subcommittee on Landmarks, Public Sitings and Dispositions (preconsidered but laid over by the Subcommittee on Landmarks, Public Sitings and Dispositions). Landmarks, Public Sitings and Dispositions).

## Preconsidered L.U. No. 296

By Council Member Salamanca:

**Application number C 220426 ZMR (541-545 Bay Street) submitted by Epsilon Enterprises Realty, LLC, pursuant to Sections 197-c and 201 of the New York City Charter for an amendment of the Zoning Map, Section No. 21c, changing from a C4-2 District to an R6 District, establishing within a proposed R6 District a C2-3 District, and establishing a Special Bay Street Corridor District (BSC), Borough of Staten Island, Community District 1, Council District 49.**

Referred to the Committee on Land Use and the Subcommittee on Zoning and Franchises (preconsidered but laid over by the Subcommittee on Zoning and Franchises).

## Preconsidered L.U. No. 297

By Council Member Salamanca:

**Application number N 220392 ZRR (541-545 Bay Street) submitted by Epsilon Enterprises Realty, LLC, pursuant to Section 201 of the New York City Charter, for an amendment of the Zoning Resolution of the City of New York, modifying Article XIII, Chapter 5 (Special Bay Street Corridor District) to create a new Subdistrict and APPENDIX F for the purpose of establishing a Mandatory Inclusionary Housing area, Borough of Staten Island, Community District 1, Council District 49.**

Referred to the Committee on Land Use and the Subcommittee on Zoning and Franchises (preconsidered but laid over by the Subcommittee on Zoning and Franchises).

NEW YORK CITY COUNCIL

**A N N O U N C E M E N T S**

**Thursday, December 7, 2023**

Committee on Sanitation and Solid Waste Management jointly with the Sandy Nurse, Chairperson  
Committee on Health Lynn C. Schulman, Chairperson  
**Oversight** - Rat Mitigation and Public Health  
 Council Chambers – City Hall.....10:00 a.m.

Committee on General Welfare jointly with the Diana I. Ayala, Chairperson  
Committee on Mental Health, Disabilities & Addiction and the Linda Lee, Chairperson  
Committee on Veterans and the Robert F. Holden, Chairperson  
Committee on Housing and Buildings Pierina Ana Sanchez, Chairperson

**Oversight** - Supportive Housing in New York City.  
**Int 1153** - By Council Members Nurse, Hanif, Ossé, Restler, Cabán, Ayala, Richardson Jordan, Won, Feliz, De La Rosa, Williams, Marte, Sanchez, Avilés, Narcisse, Hudson, Brewer, Krishnan, Gutiérrez, Farías and Rivera  
 - **A Local Law** to amend the administrative code of the city of New York, in relation to requiring monthly reports on removals of individuals experiencing homelessness and the outcomes for those individuals.  
 Council Chambers – City Hall.....1:00 p.m.

**Monday, December 11, 2023**

Committee on Finance Justin Brannan, Chairperson  
**Oversight** – Mayor’s November Financial Plan  
 Council Chambers – City Hall.....10:00 a.m.

**Tuesday, December 12, 2023**

Committee on Aging Crystal Hudson, Chairperson

**Oversight** – Older Adult Workforce Programs  
**Res 758** – By Council Members Hudson, Louis, Farías, Schulman and Hanif – **Resolution** calling on the New York State Legislature to pass, and the Governor to sign, S.884/A.6331, to direct the New York State Office for the Aging and the Empire State Development Corporation to expand encore entrepreneurship in New York State to empower individuals 50 years of age or older to establish small businesses.  
**Res 760** – By Council Members Hudson, Stevens, Gutiérrez, Louis, Farías, Schulman and Hanif – **Resolution** calling on the New York State Legislature to pass, and the Governor to sign, S.3004/A.6324, which would establish an Office of Older Adult Workforce Development within the State Office for the Aging.  
 Committee Room – City Hall.....10:00 a.m.

Subcommittee on Zoning & Franchises Kevin C. Riley, Chairperson  
**See Land Use Calendar**  
 Committee Room – 250 Broadway, 16th Floor..... 11:00 a.m.

Subcommittee on Landmarks, Public Sitings and Dispositions Farah N. Louis, Chairperson  
**See Land Use Calendar**  
 Committee Room – 250 Broadway, 16th Floor..... 11:30 a.m.

[Committee on Land Use](#)

Rafael Salamanca, Jr., Chairperson

**All items reported out of the Subcommittees**

AND SUCH OTHER BUSINESS AS MAY BE NECESSARY

Committee Room – 250 Broadway, 16th Floor.....12:00 p.m.

[Committee on Contracts](#) jointly with the  
[Committee on Small Business](#) and the  
[Committee on Economic Development](#)

Julie Won, Chairperson  
Julie Menin, Chairperson  
Amanda Farías, Chairperson

**Oversight** - The Role of Small Businesses in Shelter Food Procurement.

Committee Room – City Hall.....1:00 p.m.

[Committee on Environmental Protection,  
Resiliency and Waterfronts](#)

James F. Gennaro, Chairperson

**Oversight** - The City's Obligation to Reduce Carbon Emissions from Government Operations.

Council Chambers – City Hall.....1:00 p.m.

**Wednesday, December 13, 2023**

[Committee on Consumer and Worker Protection](#)

Marjorie Velázquez, Chairperson

**Oversight** - Street Vending in NYC

**Int 1060** – By Council Members Menin, Velázquez, Brooks-Powers and Riley – **A Local Law** to amend the administrative code of the city of New York, in relation to prohibiting vending or vendor-related activity in bicycle lanes.

**Int 1062** – By Council Members Velázquez and Menin – **A Local Law** to amend the administrative code of the city of New York, in relation to vendor display and storage of goods, and to repeal sections 17-313 and 20-463 of such code, relating to bookkeeping requirements.

**Int 1188** – By Council Members Velázquez, Menin and Riley – **A Local Law** to amend the administrative code of the city of New York, in relation to the requirement of food vendors to obtain a certificate of authority to collect sales tax.

**Int 1253** - By Council Members De La Rosa, Sanchez, Farías, Krishnan, Hanif, Ayala, Ossé, Cabán, Nurse, Marte, Restler, Gutiérrez, Won, Avilés, Hudson, Louis and the Public Advocate (Mr. Williams) - **A Local Law** to amend the administrative code of the city of New York, in relation to permitting street vendors to vend within two feet from the curb.

**Int 1264** - By Council Members Krishnan, Sanchez, Farías, De La Rosa, Hanif, Ayala, Ossé, Cabán, Nurse, Marte, Restler, Gutiérrez, Won, Avilés, Hudson, Louis and the Public Advocate (Mr. Williams) - **A Local Law** to amend the administrative code of the city of New York, in relation to repealing the misdemeanor criminal penalties for general vendors and mobile food vendors.

Committee Room – City Hall.....1:00 p.m.

[Committee on Cultural Affairs, Libraries &  
International Intergroup Relations](#)

Chi A. Ossé, Chairperson

**Oversight** - Arts and Cultural Organizations’ Outreach into New York City Communities.

**Res 423** - By Council Members Rivera, Barron, Hudson, Restler, Louis, Hanif, Richardson Jordan, Avilés, Farías, De La Rosa, Marte, Brannan, Ossé, Brewer, Krishnan, Nurse, Won, Cabán, Gutiérrez, Ayala, Powers, Sanchez, Joseph, Botcher, Holden, Riley, Stevens and the Public Advocate (Mr. Williams) - **Resolution** calling on Congress and the President to move significant funds away from the military budget in order to fund social services, and to hold in-depth public hearings on the basic human needs of City residents that are unmet because of government appropriations for the Pentagon.

Council Chambers – City Hall.....1:00 p.m.

**Thursday, December 14, 2023**

[Subcommittee on Zoning & Franchises](#)  
**See Land Use Calendar**

Kevin C. Riley, Chairperson

Committee Room – 250 Broadway, 16th Floor.....11:00 a.m.

[Committee on Education](#) jointly with the  
[Committee on State and Federal Legislation](#)

Rita Joseph, Chairperson  
Shaun Abreu, Chairperson

**Oversight** - New Phonics Based Curriculum and Dyslexia Screening in NYC Public Schools.

Council Chambers – City Hall.....1:00 p.m.

[Committee on Youth Services](#) jointly with the  
[Committee on General Welfare](#)

Althea V. Stevens, Chairperson  
Diana I. Ayala, Chairperson

**Oversight** - Preventative Services for At-Risk and Justice Involved Youth.

**Int 757** - By Council Members Farías, Williams, Riley, Louis, Krishnan, Velázquez, Dinowitz and Schulman -  
**A Local Law** to amend the administrative code of the city of New York, in relation to establishing a system to obtain employment and income information from a third-party for the city’s use in making determinations for benefits and services eligibility.

Committee Room – City Hall.....1:00 p.m.

**Friday, December 15, 2023**

[Committee on Public Safety](#) jointly with the  
[Committee on Technology](#)

Kamillah Hanks, Chairperson  
Jennifer Gutiérrez, Chairperson

**Oversight** - NYPD’s Implementation of the Public Oversight of Surveillance Technology (POST) ACT.

**Int 1193** – By Council Members Farías and Gutiérrez – **A Local Law** to amend the administrative code of the city of New York, in relation to the department of investigation’s oversight of the police department use of surveillance technology.

**Int 1195** – By Council Members Hudson, Brewer and Gutiérrez – **A Local Law** to amend the administrative code of the city of New York, in relation to the establishment of a police department policy for using facial recognition technology and regular audits to ensure compliance.

**Int 1207** – By Council Members Won and Marte – **A Local Law** to amend the administrative code of the city of New York, in relation to police department transparency in the use of surveillance technology.

Council Chambers – City Hall.....1:00 p.m.

**Tuesday, December 19, 2023**

[Committee on Land Use](#)

Rafael Salamanca, Jr., Chairperson

**All items reported out of the Subcommittees**  
**AND SUCH OTHER BUSINESS AS MAY BE NECESSARY**

Committee Room – 250 Broadway, 16th Floor.....11:00 a.m.

[Committee on Civil Service and Labor](#)

Carmen De La Rosa, Chairperson

**Oversight** - DCAS Professional Development Trainings.

Council Chambers – City Hall.....1:00 p.m.

**Wednesday, December 20, 2023**

Committee on Finance

Justin Brannan, Chairperson

**Preconsidered Res \_\_\_** - By Council Member Brannan - Resolution approving the new designation and changes in the designation of certain organizations to receive funding in the Expense Budget.

AND SUCH OTHER BUSINESS AS MAY BE NECESSARY

Committee Room – City Hall..... 10:00 a.m.

Stated Council Meeting

**Council Chambers – City Hall.....Agenda – 1:30 p.m**

The following comments were among the remarks made by the Speaker (Council Member Adams) during the Communication from the Speaker segment of this meeting:

The Speaker (Council Member Adams) acknowledged that Samara Swanston would be departing the Council after serving sixteen years as the counsel to the Committee on Environmental Protection. She thanked Ms. Swanston for her many years of dedicated public service. The Speaker (Council Member Adams) wished Ms. Swanston the very best on her next chapter in life as those assembled applauded in appreciation.

The Speaker (Council Member Adams) acknowledged that December 7<sup>th</sup> marked the first night of Hanukkah. She extended her warmest wishes for peace and joy to Jewish families across New York City and around the world during the holiday season. On behalf of the Council, the Speaker (Council Member Adams) wished a *Chag Hanukkah Sameach* to all observing.

The Speaker (Council Member Adams) acknowledged the New Yorkers who had lost their lives during the past few weeks whether due to fires, traffic incidents, or other forms of violence. She noted that real solutions were needed to make communities safer and to allow healing for those who experienced tragedy. The Speaker (Council Member Adams) noted that safety and access to services remained a priority for the Council. She reiterated that it was imperative to continue to take action on achieving the progress and safety that New Yorkers deserve.

\* \* \*

Whereupon on motion of the Speaker (Council Member Adams), the Majority Leader and Acting President Pro Tempore (Council Member Powers) adjourned these proceedings to meet again for the Stated Meeting of Wednesday, December 20, 2023.

MICHAEL M. McSWEENEY, City Clerk  
Clerk of the Council

*Editor's Note:* For the transcript of these proceedings, please refer to the respective attachment section of items introduced or adopted at this Stated Meeting of December 6, 2023 on the New York City Council website at <https://council.nyc.gov>.

*Editor's Local Law Note:* Int. Nos. 687-A, 845-A, 1083-A, and 1208, all adopted by the Council at the November 2, 2023 Stated Meeting, were **signed into law by the Mayor** on November 17, 2023 as, respectively, Local Law Nos. 150 to 153 of 2023.

Int. Nos. 102-A, 712-A, 790-B, 1026-A, 1084-A, 1119-A, and 1164-A, all adopted at the October 19, 2023 Stated Meeting, were **returned unsigned by the Mayor** on November 21, 2023. These items had become law by November 19, 2023 due to the lack of Mayoral action within the Charter-prescribed thirty day time period. These bills were assigned subsequently as Local Laws Nos. 154 to 160 of 2023, respectively,

Int. Nos. 569-B, 816, 968-B, 1191, and 1192, all adopted at the November 2, 2023 Stated Meeting, were **returned unsigned by the Mayor** on December 4, 2023. These items had become law by December 3, 2023 due to the lack of Mayoral action within the Charter-prescribed thirty day time period. These bills were assigned subsequently as Local Laws Nos. 161 to 165 of 2023, respectively,

Int. No. 1070-A, adopted by the Council at the November 15, 2023 Stated Meeting, was **signed into law by the Mayor** on December 4, 2023 as Local Law No. 166 of 2023.