



COLD-FORMED STEEL

Local Law 148 of 2021, Case Studies & Common Errors



build safe | live safe

presented by

MATT MILLNER, P.E.

COPYRIGHT

This presentation is protected by United States and International Copyright laws. Reproduction, distribution, display and use of the presentation without written permission of the speaker is prohibited.

© 2022 *New York City Department of Buildings*

DISCLAIMER

The information in this document is only a summary and overview and is not intended to substitute for the full text and meaning of any law, rule or regulation. The City disclaims any liability for errors that may be contained in this document and shall not be responsible for any damages, consequential or actual, arising out of or in connection with the use of this document and/or the information contained herein. The City reserves the right to take action at variance with this document. This document shall not be construed to create a substantive or procedural right or benefit enforceable by any person. The information contained in this document is current only as of the publication date of this document.

© 2022 *New York City Department of Buildings*

PRESENTATION DESCRIPTION

This presentation will provide an overview of **Local Law 148 of 2021**. The changes, modification, and additions to **Chapters 17 and 33** of the **NYC Building Code** will be reviewed. Case studies will be used to highlight the importance of this Law and associated requirements. Common errors and omissions will be noted to highlight critical aspects of the subject matter.



COLD-FORMED STEEL RESOURCES

COLD-FORMED STEEL RESOURCES

Recent Related Department Resources

Local Law 148/2021
Int. No. 2264-A

By Council Members Comegy, Chin, Kallos and Louis (by request of the Mayor)

A Local Law to amend the New York city building code, in relation to cold-formed steel construction

Be it enacted by the Council as follows:

Section 1. Table 1705.2.6 of chapter 17 of the New York city building code, as amended by a local law for the year 2021, relating to bringing the administrative code of the city of New York, the New York city plumbing code, the New York city building code, the New York city mechanical code and the New York city fuel gas code and related provisions of law up to date with the 2015 editions of the international building, mechanical, fuel gas and plumbing codes, is amended to read as follows:

Local Law 148 of 2021

https://www1.nyc.gov/assets/buildings/local_laws/ll148of2021.pdf

- Amended the New York City Building Code in relation to cold-formed steel construction

COLD-FORMED STEEL RESOURCES

Recent Related Department Resources

Local Law 148/2021
Int. No. 2264-A

By Council Members Cornegy, Chin, Kallos and Louis (by request of the Mayor)

A Local Law to amend the New York city building code, in relation to cold-formed steel construction

Be it enacted by the Council as follows:



Section 1. Table 1705.2.6 of chapter 17 of the New York city building code, as amended by a local law for the year 2021, relating to bringing the administrative code of the city of New York, the New York city plumbing code, the New York city building code, the New York city mechanical code and the New York city fuel gas code and related provisions of law up to date with the 2015 editions of the international building, mechanical, fuel gas and plumbing codes, is amended to read as follows:

Local Law 148 of 2021

EFFECTIVE DATE

- **Key Date – November 7, 2022**
- For projects that require a site safety plan to be filed with DOB, Local Law 148 of 2021 is applicable to projects whose site safety plan is **approved** on or after **November 7, 2022**.
- For projects that **do not require a site safety plan to be filed** with DOB, Local Law 148 of 2021 is applicable to projects whose **construction documents are submitted** on or after **November 7, 2022**

COLD-FORMED STEEL RESOURCES



NYC Buildings Department
280 Broadway, New York, NY 10007
Melanie E. La Rocca, Commissioner

BUILDINGS BULLETIN 2019-011
Technical

Issuer: Gus Sirakis, P.E. *G. Sirakis*
First Deputy Commissioner

Issuance Date: December 2, 2019

Purpose: This bulletin highlights cold-formed steel light-frame construction requirements for special inspectors, construction superintendents, design professionals, and permit holders.

Related Code/Zoning Section(s):

BC 1702	BC 1704.1	BC 1704.3.4	BC 2210
BC 2210.3.2	BC 2210.1 thru 2210.7	BC 3301.7	BC 3301.13
BC 3301.4	BC 3305	AC 28-116.1	

Subject(s): Cold-formed steel light-frame construction; Cold-formed steel light-frame bracing and assembly; Cold-formed steel light-frame design; Cold-formed steel light-frame special inspection; Documentation required on site; Construction superintendent; Registered General Contractor; Special inspector.

I. Background

This bulletin highlights requirements specific to the erection of cold-formed steel light-frame construction for special inspectors, construction superintendents, general contractors, design professionals, and permit holders.

Cold-Formed Steel Building Bulletin 2019-011 (https://www1.nyc.gov/assets/buildings/bldgs_bulletins/bb_2019-011.pdf)

- Applies to jobs that are filed under the 2014 NYC Building Code
- These items have been incorporated into Local Law 148 of 2021

COLD-FORMED STEEL RESOURCES

NYC
Buildings

December 2019

SERVICE NOTICE

Overloading and Improper Installation of Cold-Formed Steel (Light-Frame Construction) Can Result in Injury and Property Damage



Overloading and improper installation of cold-formed steel including joists, rafters, trusses, and structural wall studs, etc., can result in injury and property damage.

Materials and equipment may only be placed on finished decking where directed by your supervisor. No placed load should exceed the capacity of the framing/decking.



Cranes (or similar) should not be allowed to deposit material or equipment on a deck without permission from the construction superintendent.

Do not remove bracing or shoring unless directed by your supervisor. (see *Figure A*)

Do not go onto any section of deck that is being formed unless you are experienced with laying deck and have discussed the operation with the construction superintendent before beginning the work.

Your employer is required to provide fall protection. Do not go near any uncovered holes or unprotected edges unless you are wearing a harness and tied off to a lifeline.

Do not cut or drill through cold-formed steel, run all utilities through provided openings. (see *Figure B*)



For more information, please see [Buildings Bulletin 2019-011](#).

POST UNTIL: December 31, 2019

Melanie E. La Rocca, Commissioner
build safe | live safe

nyc.gov/buildings

Big Picture Theme(s)

- Improper construction implementation has been documented
 - Loading prior to being fully set
 - Overloading framing
 - Unapproved structural modifications
 - Fall protection deficiencies

Service Notice December 2019

https://www1.nyc.gov/assets/buildings/pdf/cold_form_steel_s_n.pdf



COLD-FORMED STEEL

Local Law 148 of 2021 Review & Case Studies

COLD-FORMED STEEL: LOCAL LAW 148 OF 2021

Local Law 148 of 2021

- Impacted NYC Building Code Chapters
 - Chapter 17, **Table 1705.2.6**
 - Replaces 2014 NYC Building Code **Table 1704.3.4**
 - Chapter 33, new section **BC3305.8**

COLD-FORMED STEEL: CHAPTER 17

TYPE	CONTINUOUS SPECIAL INSPECTION	PERIODIC SPECIAL INSPECTION	REFERENCED STANDARD
1. Material Verification:			
a. Verify that identification markings conform to AISI S240 and as specified in the approved construction documents.	X		AISI S240, Section D6.5
b. Verify that material is clean, straight and undamaged.		X	
2. Inspection of general framing:			
a. Verify that member sizes conform to the approved construction documents.		X	AISI S240 Section C
b. Verify that member layout conforms to the approved construction documents.		X	
c. Verify that proper bearing lengths are provided in accordance with approved construction documents.		X	
d. Verify that punched holes and sheared or flame cut edges of material in members are clean and free from notches and burred edges.		X	

Table 1705.2.6

Required Special Inspection of Cold-Formed Steel Construction

Sections 1 & 2

- Material Verification
- Inspection of General Framing

COLD-FORMED STEEL: CHAPTER 17

TYPE	CONTINUOUS SPECIAL INSPECTION	PERIODIC SPECIAL INSPECTION	REFERENCED STANDARD
1. Material Verification:			
a. Verify that identification markings conform to AISI S240 and as specified in the approved construction documents.	X		AISI S240, Section D6.5
b. Verify that material is clean, straight and undamaged.		X	
2. Inspection of general framing:			
a. Verify that member sizes conform to the approved construction documents.		X	AISI S240 Section C
b. Verify that member layout conforms to the approved construction documents.		X	
c. Verify that proper bearing lengths are provided in accordance with approved construction documents.		X	
d. Verify that punched holes and sheared or flame cut edges of material in members are clean and free from notches and burred edges.		X	

What has changed from 2014 NYCBC Table 1704.3.4?

- **Section 1a** – Changed from periodic to continuous; reference standard updated to AISI S240, Section D6.5
- **Section 2** – Referenced standard updated to AISI S240 Section C

COLD-FORMED STEEL: CHAPTER 17

TYPE	CONTINUOUS SPECIAL INSPECTION	PERIODIC SPECIAL INSPECTION	REFERENCED STANDARD
3. Inspection of framing connections and anchorages:			
a. Verify that screws, bolts, and other fasteners conform to approved construction document requirements for diameter, length, quantity, spacing, edge distance, and location.		X	AISI S240, Section D6.7
b. Verify that manufactured connectors, such as joist hangers, caps, straps, clips, ties, hold-downs, and anchors conform to approved construction document requirements for manufacturer, type, gauge, and fastener requirements.		X	AISI S240 Section B1.5 and Section C4
c. Post-installed connections to concrete.	X		AISI S240 Section D6.9

Table 1705.2.6

Required Special Inspection of Cold-Formed Steel Construction

Section 3

- Inspection of Framing Connections and Anchorages

COLD-FORMED STEEL: CHAPTER 17

TYPE	CONTINUOUS SPECIAL INSPECTION	PERIODIC SPECIAL INSPECTION	REFERENCED STANDARD
3. Inspection of framing connections and anchorages:			
a. Verify that screws, bolts, and other fasteners conform to approved construction document requirements for diameter, length, quantity, spacing, edge distance, and location.		X	AISI S240, Section D6.7
b. Verify that manufactured connectors, such as joist hangers, caps, straps, clips, ties, hold-downs, and anchors conform to approved construction document requirements for manufacturer, type, gauge, and fastener requirements.		X	AISI S240 Section B1.5 and Section C4
c. Post-installed connections to concrete.	X		AISI S240 Section D6.9

What has changed from 2014 NYCBC Table 1704.3.4?

- **Section 3a** – Referenced standard updated to AISI S240 Section D6.7
- **Section 3b** – Referenced standard updated to AISI S240 Section B1.5 and Section C4
- **Section 3c** – **NEW** – Mandates continuous inspection for post-installed connections to concrete

COLD-FORMED STEEL: CHAPTER 17

TYPE	CONTINUOUS SPECIAL INSPECTION	PERIODIC SPECIAL INSPECTION	REFERENCED STANDARD
4. Inspection of welding:			
a. Inspect welds in accordance with S240 Section D6.6.		X	AWS D1.3, AISI S240 Section D6.6
b. Additional requirements for welds performed as a part of a lateral force-resisting system.	X Note a		AISI S240 Section D6.9

Table 1705.2.6

Required Special Inspection of Cold-Formed Steel Construction

Section 4

- Inspection of Welding

COLD-FORMED STEEL: CHAPTER 17

TYPE	CONTINUOUS SPECIAL INSPECTION	PERIODIC SPECIAL INSPECTION	REFERENCED STANDARD
4. Inspection of welding:			
a. Inspect welds in accordance with S240 Section D6.6.		X	AWS D1.3, AISI S240 Section D6.6
b. Additional requirements for welds performed as a part of a lateral force-resisting system.	X Note a		AISI S240 Section D6.9

Note a: In accordance with AISI S240 Section D6.9.1, continuous special inspection of weld fit-up in lateral force-resisting systems may be reduced to periodic special inspection upon fulfillment of the conditions of Section D6.9.1.

What has changed from 2014 NYCBC Table 1704.3.4?

- **Section 4a** – Updated to reference AISI S240 Section D6.6 in addition to the existing AWS D1.3
- **Section 4b** – **NEW** – Continuous inspection required for welds performed as part of a lateral-force resisting system
 - Note a indicates that this may be conditionally reduced to a periodic inspection

COLD-FORMED STEEL: CHAPTER 17

TYPE	CONTINUOUS SPECIAL INSPECTION	PERIODIC SPECIAL INSPECTION	REFERENCED STANDARD	BC REFERENCE
5. Bracing:				
a. Verify that temporary bracing, shoring, jacks, etc., are installed, modified and not removed until no longer necessary, in accordance with the approved construction documents and approved erection drawings as required by Sections 3305.8.6.8 and 3305.8.7.5.		X	AISI S240 Section E6	
b. Verify that permanent bracing, web stiffeners, bridging, blocking, wind bracing, etc. are installed in accordance with the approved construction documents and approved erection drawings, as required by Sections 3305.8.6.8 and 3305.8.7.5.		X		
c. Where a cold-formed steel truss clear span is 60 feet (18 288 mm) or greater, the special inspector shall verify that the temporary installation restraint/bracing and the permanent individual truss member restraint/bracing are installed in accordance with the approved truss submittal package.		X		2211.1.3.2

Table 1705.2.6

Required Special Inspection of Cold-Formed Steel Construction

Section 5

- Bracing

COLD-FORMED STEEL: CHAPTER 17

TYPE	CONTINUOUS SPECIAL INSPECTION	PERIODIC SPECIAL INSPECTION	REFERENCED STANDARD	BC REFERENCE
5. Bracing:				
a. Verify that temporary bracing, shoring, jacks, etc., are installed, modified and not removed until no longer necessary, in accordance with the approved construction documents and approved erection drawings as required by Sections 3305.8.6.8 and 3305.8.7.5.		X	AISI S240 Section E6	
b. Verify that permanent bracing, web stiffeners, bridging, blocking, wind bracing, etc. are installed in accordance with the approved construction documents and approved erection drawings, as required by Sections 3305.8.6.8 and 3305.8.7.5.		X		
c. Where a cold-formed steel truss clear span is 60 feet (18 288 mm) or greater, the special inspector shall verify that the temporary installation restraint/bracing and the permanent individual truss member restraint/bracing are installed in accordance with the approved truss submittal package.		X		2211.1.3.2

What has changed from 2014 NYCBC Table 1704.3.4?

- **Section 5a**
 - Added **modified**
 - Added reference to new Sections 3305.8.6.8 and 3305.8.7.5
- **Section 5b**
 - Added reference to new Sections 3305.8.6.8 and 3305.8.7.5

COLD-FORMED STEEL: CHAPTER 17

TYPE	CONTINUOUS SPECIAL INSPECTION	PERIODIC SPECIAL INSPECTION	REFERENCED STANDARD
6. Pre-installation Document Submittals		X	AISI S240, Section D3
7. Lateral Force-Resisting System Additional Requirements		X	AISI S240 Section D6.9

Table 1705.2.6

Required Special Inspection of Cold-Formed Steel Construction

NEW Sections 6 & 7

- Pre-installation Document Submittals
- Lateral Force-Resisting System Additional Requirements

COLD-FORMED STEEL: CHAPTER 33

§3305.8 Cold-formed Steel Light-frame Construction

- **NEW** section of Chapter 33 of the Building Code for Cold-formed steel light-frame construction
- Covers the **installation**, and **use**
- AISI S240 is applicable
- Chapter 22 of the Building Code applicable for design

3305.8 Cold-formed steel light-frame construction. The installation of cold-formed steel light-frame construction, the installation of decking on cold-formed steel light-frame construction, as well as the use of such framing and decking during construction or demolition operations shall be in accordance with the requirements of AISI S240 and the following sections. The design of cold-formed steel light-frame construction and decking on cold-formed steel light-frame construction shall meet the requirements of Chapter 22.

COLD-FORMED STEEL: CHAPTER 33

§3305.8 Cold-formed Steel Light-frame Construction

■ Topics Covered

- **§3305.8.1** Cutting, Notching, and Splicing
- **§3305.8.2** Uniform Bearing Surface
- **§3305.8.3** Corrosion Protection
- **§3305.8.4** Screw Connections
- **§3305.8.5** In-line Framing
- **§3305.8.6** Joists, Decking, and Shoring and Bracing
- **§3305.8.7** Placing Loads on Cold-formed Steel
- **§3305.8.8** Inspection Checklist

COLD-FORMED STEEL: CHAPTER 33

§3305.8.1 Cutting, Notching, and Splicing

- Only allowed if indicated on design drawings or erection drawings approved by a registered design professional (RDP)

3305.8.1 Cutting, notching, and splicing. Cutting, notching, and splicing of cold-formed steel structural members shall be performed only in accordance with specifications as indicated on drawings, including but not limited to erection drawings, approved by a registered design professional.

COLD-FORMED STEEL: CHAPTER 33

§3305.8.2 Uniform Bearing Surface

- Uniform bearing surface shall be provided
- Gap between bottom track and uniform bearing surface cannot exceed $\frac{1}{4}$ "
- Leveling must be approved by RDP

- Shims: *or*

3305.8.2 Uniform bearing surface. A uniform bearing surface shall be provided under cold-formed steel structural members. In no case shall the gap between the bottom track and the uniform bearing surface exceed $\frac{1}{4}$ of an inch (6.4 mm). Leveling shall be subject to the approval of a registered design professional and shall be achieved through the use of either load bearing shims or grout.

COLD-FORMED STEEL: CHAPTER 33

§3305.8.3 Corrosion Protection

3305.8.3 Corrosion protection. The following precautions shall be taken to prevent corrosion of cold-formed steel structural members:

1. Dissimilar metals shall not be used in direct contact with cold-formed steel framing members unless approved for that application by the registered design professional of record for the cold-formed steel framing system.
2. Cold-formed steel framing members shall not be embedded in concrete unless approved for that application by the registered design professional of record for the cold-formed steel framing system.
3. Fasteners shall have a corrosion-resistant treatment, or be manufactured from material not susceptible to corrosion.
4. Welded connections shall be protected with a treatment, approved by the registered design professional of record for the cold-formed steel framing system, to retain corrosion resistance of the welded area.

COLD-FORMED STEEL: CHAPTER 33

§3305.8.4 Screw Connections

- Minimum through steel connection with three exposed threads
- Stripped screws
 - Cannot be in direct tension
 - 25% allowance for stripped screws in shear

3305.8.4 Screw connections. Screw fasteners in cold-formed steel structural members shall extend through the steel connection with a minimum of three exposed threads.

3305.8.4.1 Stripped screws in direct tension prohibited. Stripped screws in direct tension shall not be permitted.

3305.8.4.2 Stripped screws in shear connections. Stripped screws in shear connections shall only be permitted if the number of stripped screw fasteners does not exceed 25% of the total number of fasteners in the connection.

COLD-FORMED STEEL: CHAPTER 33

§3305.8.5 In-line Framing

- Vertical alignment with stud required

EXCEPTION: when there is a designed load distribution member

3305.8.5 In-line framing. Each joist, rafter, truss, and structural wall stud (above or below) shall be aligned vertically in accordance with the limits depicted in Figure B1.2.3-1 of AISI S240.

Exception: The alignment tolerance depicted in Figure B1.2.3-1 of AISI S240 shall not be required to be met when a structural load distribution member is specified in accordance with the approved construction documents.

COLD-FORMED STEEL: IN-LINE FRAMING

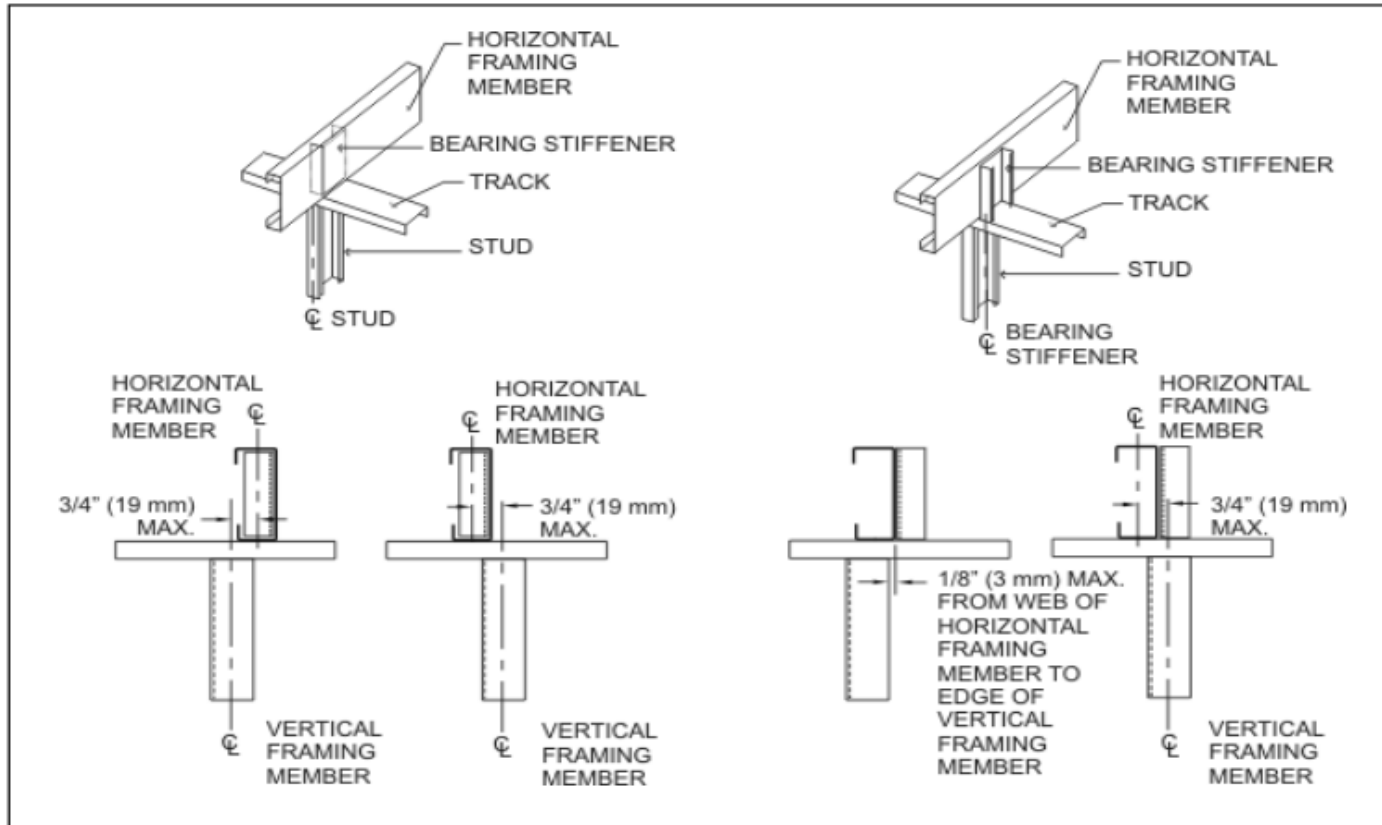

(Source AISI S240-15)

AISI S240-15
(North American Standard for Cold-Formed Steel Framing)

Figure B1.2.3-1

CASE STUDY 1: COLD-FORMED STEEL IN-LINE FRAMING

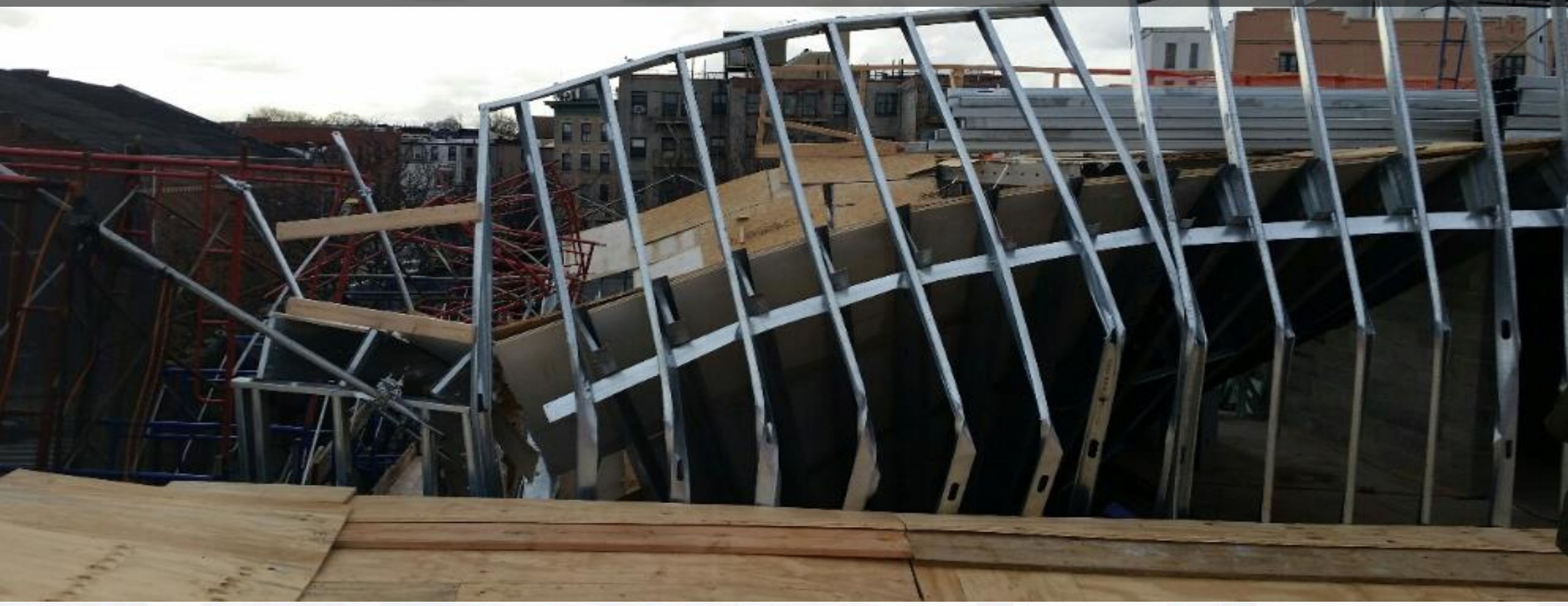

A photograph showing a close-up of a cold-formed steel framing system. The structure consists of vertical studs and horizontal tracks. Yellow cables are routed through the system, secured by blue brackets and metal plates. The background shows a concrete wall with some surface imperfections.

CASE STUDY 1: COLD-FORMED STEEL IN-LINE FRAMING

COLD-FORMED STEEL: CHAPTER 33

§3305.8.6.1 Joist, Decking, Shoring and Bracing

Applicable to:

- Joists
- Temporary decking
- Permanent decking; and
- Shoring and bracing for joists and decking

Shall be installed in accordance with the requirements of Section **3305.8.6.1** through **3305.8.6.9**.

COLD-FORMED STEEL: CHAPTER 33

§3305.8.6.1 Joist, Decking, Shoring and Bracing – Installed as Indicated on Drawings

Shall be installed as indicated on drawings, including but not limited to erection drawings, approved by a registered design professional.

Such drawings shall be specific to the site and shall, at a **minimum**, indicate the following details:

Drawing Requirements

1. Joists
2. Permanent decking material
3. Allowable temporary decking material

COLD-FORMED STEEL: CHAPTER 33

§3305.8.6.1 Joist, Decking, Shoring and Bracing – Installed as Indicated on Drawings *(continued)*

Drawing Requirements

4. Members and fasteners, including bridging, strapping, stiffeners, and placement of diaphragm
5. Shoring and bracing, whether permanent or temporary, for joists, trusses, and decking, through all phases of work, including interim sequences
6. Allowable designated temporary loading areas, or if no designated temporary loading areas are specified, a note that no temporary loading is allowed

COLD-FORMED STEEL: CHAPTER 33

§3305.8.6.1 Joist, Decking, Shoring and Bracing – Installed as Indicated on Drawings *(continued)*

Drawing Requirements

7. Types of materials and maximum loads allowed in each temporary loading area
8. The permissible live and construction loads of the decking (temporary and permanent) and structure outside of temporary loading areas;
9. The minimum spacing of deck screws required for loading of the deck (temporary and permanent) during construction; and
10. Conditions to be satisfied before temporary shoring and bracing can be removed

COLD-FORMED STEEL: CHAPTER 33

§3305.8.6.2 Ceiling Joists and Roof Trusses

- Must be laterally braced
- Type of bracing must be specified on the drawings

3305.8.6.2 Lateral bracing of floor joists. Floor joists shall be laterally braced. Types of bracing to maintain structural integrity include but are not limited to steel straps screwed to top and bottom flanges, bridging between joists, web reinforcement, cross bracing, diagonal strap bracing, wall anchorage or any other details as specified on the approved drawings.

COLD-FORMED STEEL: CHAPTER 33

§3305.8.6.3 Ceiling Joists and Roof Trusses

- Full bearing; *or*
- 1 ½” minimum bearing; *or*
- RDP design

3305.8.6.3 Ceiling joists and roof trusses. Ceiling joists and roof trusses shall be installed in accordance with one of the following:

1. With full bearing over the width of the bearing wall beneath;
2. Minimum 1 1/2 inch (38 mm) bearing end condition; or
3. In accordance with design drawings approved by a registered design professional.

COLD-FORMED STEEL: CHAPTER 33

§3305.8.6.4 Account for All Loads During Construction

- Applies to temporary or permanent framing/decking
- Applies to all construction activity
 - Includes concentrated loads (material delivery)
 - There have been failures due to unaccounted for material delivery

3305.8.6.4 Account for all loads during construction. Framing and decking, whether temporary or permanent, shall be designed to sustain all anticipated loads to be imposed by construction activity, including construction loads, concentrated loading caused by material delivery and loads generated by the movement of material and equipment.

COLD-FORMED STEEL: MATERIAL LOADING FAILURE

- Cold-formed steel framing is particularly susceptible to material loading failures during construction.
- End restraint, bridging, strapping, and blocking are critical prior to the installation of the subfloor/diaphragm.
- Design specifications for concentrated loads during delivery are required.
- These critical stability items must be identified on the design drawings to facilitate proper special inspections.



CASE STUDY 1: COLD-FORMED STEEL MATERIAL LOADING FAILURE

CASE STUDY 2: COLD-FORMED STEEL MATERIAL LOADING FAILURE



CASE STUDY 3: COLD-FORMED STEEL MATERIAL LOADING FAILURE



CASE STUDY 4: COLD-FORMED STEEL MATERIAL LOADING FAILURE & WORK CONTRARY



CASE STUDY 4: COLD-FORMED STEEL MATERIAL LOADING FAILURE & WORK CONTRARY



COLD-FORMED STEEL: CHAPTER 33

§3305.8.6.5 Bracing and Shoring for Temporary Loading Areas

- Required for all temporary loading areas
- Minimum 100 psf.
- Sound bearing for shoring/bracing is required

3305.8.6.5 Bracing and shoring for temporary loading areas. Bracing and shoring shall be provided for all temporary loading areas and shall be designed to support the maximum load allowed in the temporary loading area. In no case shall the required shoring be designed for a construction load of less than 100 psf. Bracing and shoring shall ultimately bear upon permanent structure or earth capable of sustaining the loads transmitted. The design shall also specify the criteria for the removal of any temporary bracing or shoring.

COLD-FORMED STEEL: CHAPTER 33

§3305.8.6.6 Floor Joists to be Braced Prior to Installation of Decking

- Restraint required prior to decking installation

3305.8.6.7 Placing Loads on Cold-formed Steel

- See **§3305.8.7**

3305.8.6.6 Floor joists to be braced prior to installation of decking. No decking or section of decking shall be placed on a joist until the joist has been fully installed and braced in accordance with Sections 3305.8.5 and 3305.8.6.

3305.8.6.7 Placing loads on cold-formed steel. Loads shall be placed on cold-formed steel in accordance with section 3305.8.7.

COLD-FORMED STEEL: CHAPTER 33

§3305.8.6.8 Removal or Modification of Temporary Shoring and Bracing

- Special inspection required prior to removal
- If modified, special inspector must verify compliance
- Special Inspector must document results in the checklist mandated by §3305.8.8

3305.8.6.8 Removal or modification of temporary shoring and bracing. No temporary shoring or bracing shall be removed until the cold-formed steel special inspector required by Chapter 17 has verified the shoring or bracing is no longer required in accordance with item number 10 of Section 3305.8.6.1. Modifications to temporary shoring or bracing shall be verified by the special inspector. In addition to the documentation required by Chapter 17, the special inspector shall document the verification in accordance with the checklist required by Section 3305.8.8.

COLD-FORMED STEEL: CHAPTER 33

§3305.8.6.9. Deviations

3305.8.6.9 Deviations. Deviations from the drawings required by Section 3305.8.6.1 that are not immediately corrected shall be brought to the attention of the registered design professional who prepared the drawings.

COLD-FORMED STEEL: CHAPTER 33

§3305.8.7 Placing Loads on Cold-formed Steel

- Applicable to construction and demolition
- Subsections **§3305.8.7.1** through **§3305.8.7.6**

3305.8.7 Placing loads on cold-formed steel. The placing of loads during construction or demolition work on cold-formed steel framing or on decking on cold-formed steel framing shall be in accordance with the requirements of Sections 3305.8.7.1 through 3305.8.7.6.

COLD-FORMED STEEL: CHAPTER 33

§3305.8.7 Placing Loads on Cold-formed Steel

3305.8.7.1 System in place. No person, material, or equipment shall be permitted on any joist, temporary decking or permanent decking, until all members, fasteners, shoring and bracing have been installed as indicated on the drawings required by Section 3305.8.6.1.

3305.8.7.2 Maximum loads. Loading shall not exceed that as indicated on the drawings required by Section 3305.8.6.1.

3305.8.7.3 Placed as indicated on plans. Construction loads shall only be placed in areas and to the extent as indicated on the drawings required by Section 3305.8.6.1.

COLD-FORMED STEEL: CHAPTER 33

§3305.8.7 Placing Loads on Cold-formed Steel

3305.8.7.4 Marking the temporary loading area. Temporary loading areas shall be clearly marked on the deck by spray paint or equivalent means. The markings shall indicate the boundaries of the loading area and the maximum loads allowed in the temporary loading area as specified in the drawings required by Section 3305.8.6.1.

3305.8.7.5 Verification by special inspector. No construction load shall be placed on a floor or portion of a floor until the temporary or permanent decking for the floor or such portion is in place and the cold-formed steel special inspector required by Chapter 17 has verified compliance with Section 3305.8.6, including but not limited to the drawings required by Section 3305.8.6.1. At a minimum, this special inspection shall be performed at least once for each floor. In addition to the documentation required by Chapter 17, the special inspector shall document the verification in accordance with the checklist required by Section 3305.8.6.8.

COLD-FORMED STEEL: CHAPTER 33

§3305.8.7 Placing Loads on Cold-formed Steel

3305.8.7.6 Verification inspection by a competent person. Immediately prior to the placement of any person, material or equipment on a section of cold-formed steel framing for the first time, or on a section of decking on cold-formed steel framing for the first time, a competent person designated by the construction superintendent, or where the project does not require a construction superintendent, a competent person designated by the permit holder, shall determine that the structure is ready to receive the person, material or equipment by performing an inspection that:

1. Verifies compliance with applicable drawings, specifications, and regulations, including but not limited to the approved construction documents, the erection drawings, the manufacturer specifications, and the requirements of Section 3305.8;
2. Ascertains the weight of the material or equipment to be placed, and determines it does not exceed that specified in the drawings required by Section 3305.8.6.1;
3. Confirms that any special inspections for the cold-formed steel required by Chapter 17 and Section 3305.8 have been successfully completed; and
4. Verifies compliance with the requirements of Sections 3305.8.7.1 through 3305.8.7.4.

COLD-FORMED STEEL: CHAPTER 33

§3305.8.7 Placing Loads on Cold-formed Steel

- When there is a Construction Superintendent (CS)
 - Competent person shall be in the log
- No CS
 - Competent person notarized on letterhead of permit holder

3305.8.7.6.1 Record of designation of competent person. The designation of the competent person required by Section 3305.8.7.6 shall be recorded in the construction superintendent's log required by Section 3301.13.13, or where the project does not require a construction superintendent, the designation of the competent person shall be documented in the form of a notarized letter on the letterhead of the permit holder. The record letter shall state the name and contact information of the competent person, the date of designation and shall be signed and dated by the permit holder, the competent person and the person who designated the competent person.

COLD-FORMED STEEL: CHAPTER 33

§3305.8.7 Placing Loads on Cold-formed Steel

- Records of inspection are required
- Regardless of a competent person, this does not diminish obligation of the construction superintendent or permit holder

3305.8.7.6.2 Record of inspection. The results of the inspection shall be documented in accordance with the checklist required by Section 3305.8.8.

3305.8.7.6.3 Does not diminish responsibility. The designation of a competent person does not alter or diminish any obligation imposed upon the construction superintendent or the permit holder to maintain a safe site and ensure compliance with the requirements of this code.

COLD-FORMED STEEL: CHAPTER 33

§3305.8.8 Inspection Checklist

- RDP who prepared drawings must produce inspection checklist
- Applicable to both the Special Inspector and the Construction Superintendent/Competent person.
- Minimum Checklist Requirements
 - **§3305.8.6.8** Removal or modification of temporary shoring and bracing
 - **§3305.8.7.5** Verification by special inspector
 - **§3305.8.7.6** Verification inspection by a competent person

3305.8.8 Inspection checklist. The results of the verification inspections required by Sections 3305.8.6.8, 3305.8.7.5 and 3305.8.7.6 shall be documented on a verification inspection checklist signed and dated by the person who performed the inspection. The verification inspection checklist shall be developed by the designer who prepared the drawings required by Section 3305.8.6.1.



COLD-FORMED STEEL

Common Errors & Omissions

COLD-FORMED STEEL: POTENTIAL DESIGN DEFICIENCIES

- Failing to locate/specify blocking, bridging & strapping **§3305.8.6.1**
- Failing to specify and detail web stiffeners (if required) **§3305.8.6.1**
- Inadequate bearing design or inadequate distribution member **§3305.8.6.3**
- Failing to specify loads - **§3305.8.6.1**
 - Including allowable loading during construction with types of materials
- Failing to specify temporary bracing/shoring (if required) and what conditions must be satisfied for removal **§3305.8.6.1**
- Failure to provide an inspection checklist for SIA/permit holder/CS/competent person use **§3305.8.8**

COLD-FORMED STEEL: POTENTIAL INSPECTION DEFICIENCIES

- Failure to keep a record of the inspection **§3305.8.7.6.2**
- Failure to use the inspection checklist developed by the RDP **§3305.8.8**
- Failing to identify hazardous conditions **§1704.1.2**
 - Excessive load on deck
 - Missing shoring or temporary bracing

COLD-FORMED STEEL: POTENTIAL INSPECTION DEFICIENCIES

(continued)

- Failing to note non-conformances **§1704.1.2; Table 1705.2.6**
 - Missing/improperly located blocking/bridging/strapping/stiffeners
 - Joists not in-line with studs (in-line track failure)
 - Using different materials than those specified on drawings
 - Different connection details than specified on drawings
 - Failing to verify that punched holes are free from notches and burred edges

COLD-FORMED STEEL: POTENTIAL PERMIT HOLDER FAILURES

- Not installing blocking/bridging/strapping/web stiffeners **§28-105.12.2**
- Misalignment of joists and studs without a distribution member (in-line framing failure) **§28-105.12.2; §3305.8.5**
- Failure to have a verification by a construction superintendent/competent person prior to loading **§3305.8.7.6**
- Overloading deck **and/or** loading deck before it's finished (Failure to Safeguard) **§3301.2**

COLD-FORMED STEEL: POTENTIAL PERMIT HOLDER FAILURES

(continued)

- Unapproved deviations from the design **§28-105.12.2; §3305.8.6.9**
- Failure to notify the Special Inspector prior to loading **§3305.8.7.5**
- Failing to provide shoring (if required) **§28-105.12.2; §3305.8.6.5; §3305.8.6.6**
- Failure to notify the Special Inspector prior to removal/modification of shoring/bracing **§3305.8.6.8**



nyc.gov/buildings

build safe | live safe

NYC[™]
Buildings