

Flood Resilience Zoning Text Update

Old Astoria Neighborhood
Association

June 22, 2017



#ONENYC

“A more resilient NYC is one where neighborhoods, buildings and infrastructure can withstand and recover quickly from flooding and climate events.”

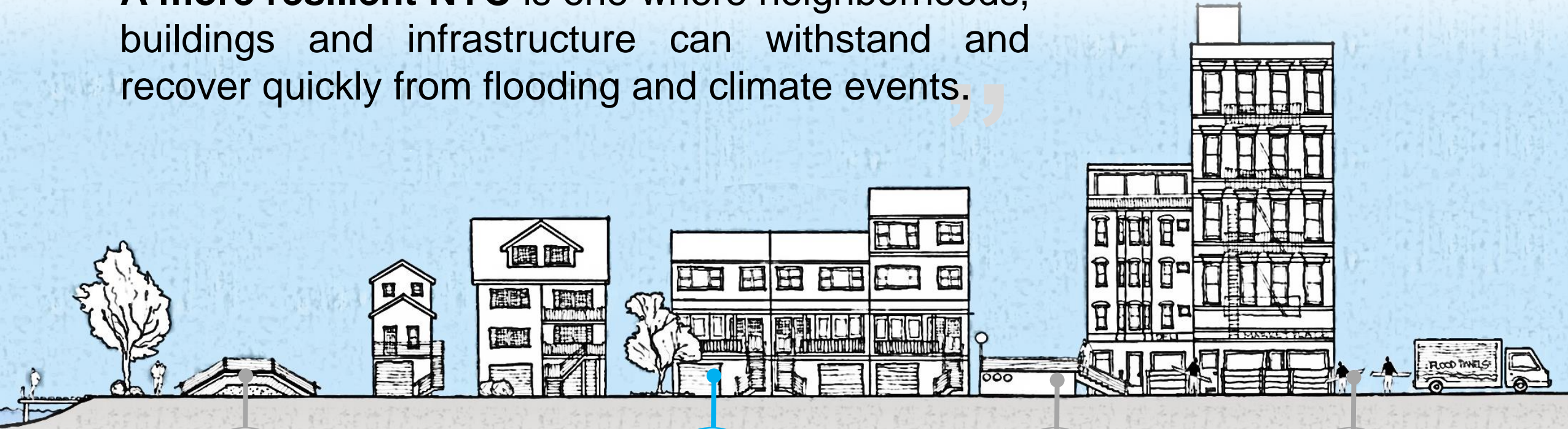

Coastal defenses

are strengthened as first line of defense against flooding and sea level rise



Buildings

are designed to withstand and recover from flooding



Infrastructure

is protected from climate hazards



Residents and businesses

are prepared

FEMA Flood Map

Citywide Flood Risk

NYC's flood risk is high.

The floodplain affects a large geography and most community and council districts.

100 Year Floodplain

FEMA 2015 PFIRM

Population: **400,000**
Buildings: **71,500**

50 of 59 Community Boards
45 of 51 Council Districts

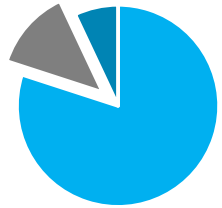

Buildings:
80% 1-4 units
7% 5+ units
13% nonresidential

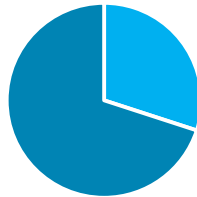

Residential
Units:
30% 1-4 units
70% 5+ units

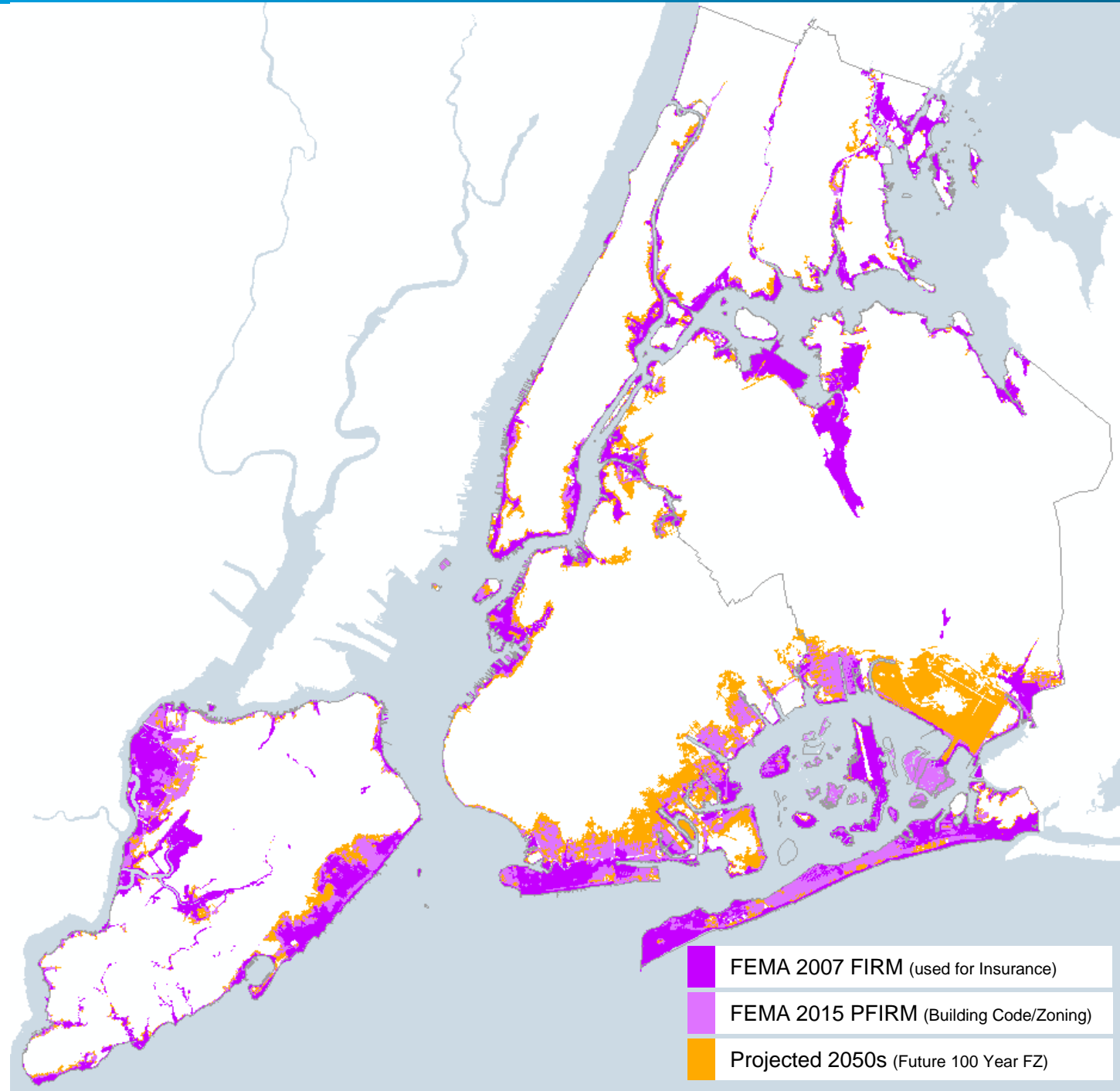

FEMA 2007 FIRM (used for Insurance)

FEMA 2015 PFIRM (Building Code/Zoning)

Projected 2050s (Future 100 Year FZ)

Future Flood Map

Flood Risk in QN CB 1

	2015 PFIRMS	2050's Projected
R units in floodplain	4,804	12,591
Buildings in floodplain	874	2,152

↑
162%

↑
146%

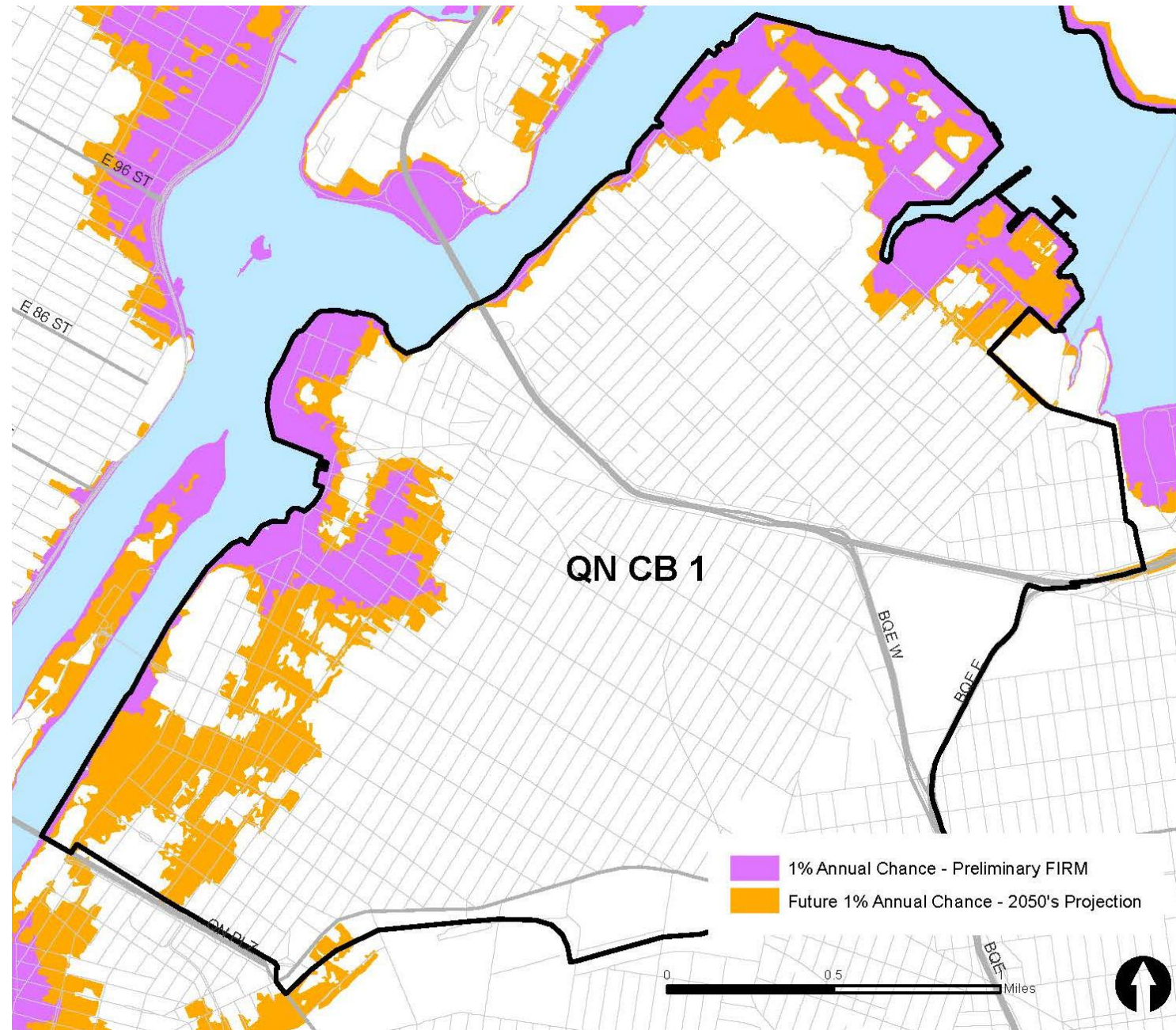

How are buildings in the floodplain regulated?



FEMA



Flood Insurance Rate Maps (FIRMs)

Determine where floodplain regulations apply

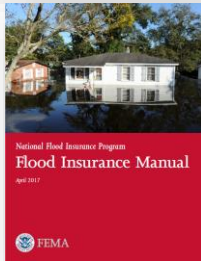

National Flood Insurance Program

Set up Insurance Rates depending on building elevation and other requirements



Construction Standards (ASCE 24)

Design minimum construction requirements for flood hazard areas

NYC



Building Code (DOB)

Requires new buildings and substantial improvements to meet FEMA standards

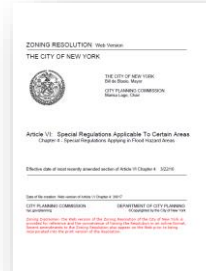

Zoning Resolution (DCP)

Zoning accommodates these regulations and improves neighborhood character



Flood resilient construction

Required by DOB

Flood resilient construction standards require certain buildings to elevate the lowest floor, as well as mechanical equipment, above the Design Flood Elevation (DFE).



Flood resilient construction

Required by DOB

Flood resilient construction standards require certain buildings to elevate the lowest floor, as well as mechanical equipment, above the Design Flood Elevation (DFE).

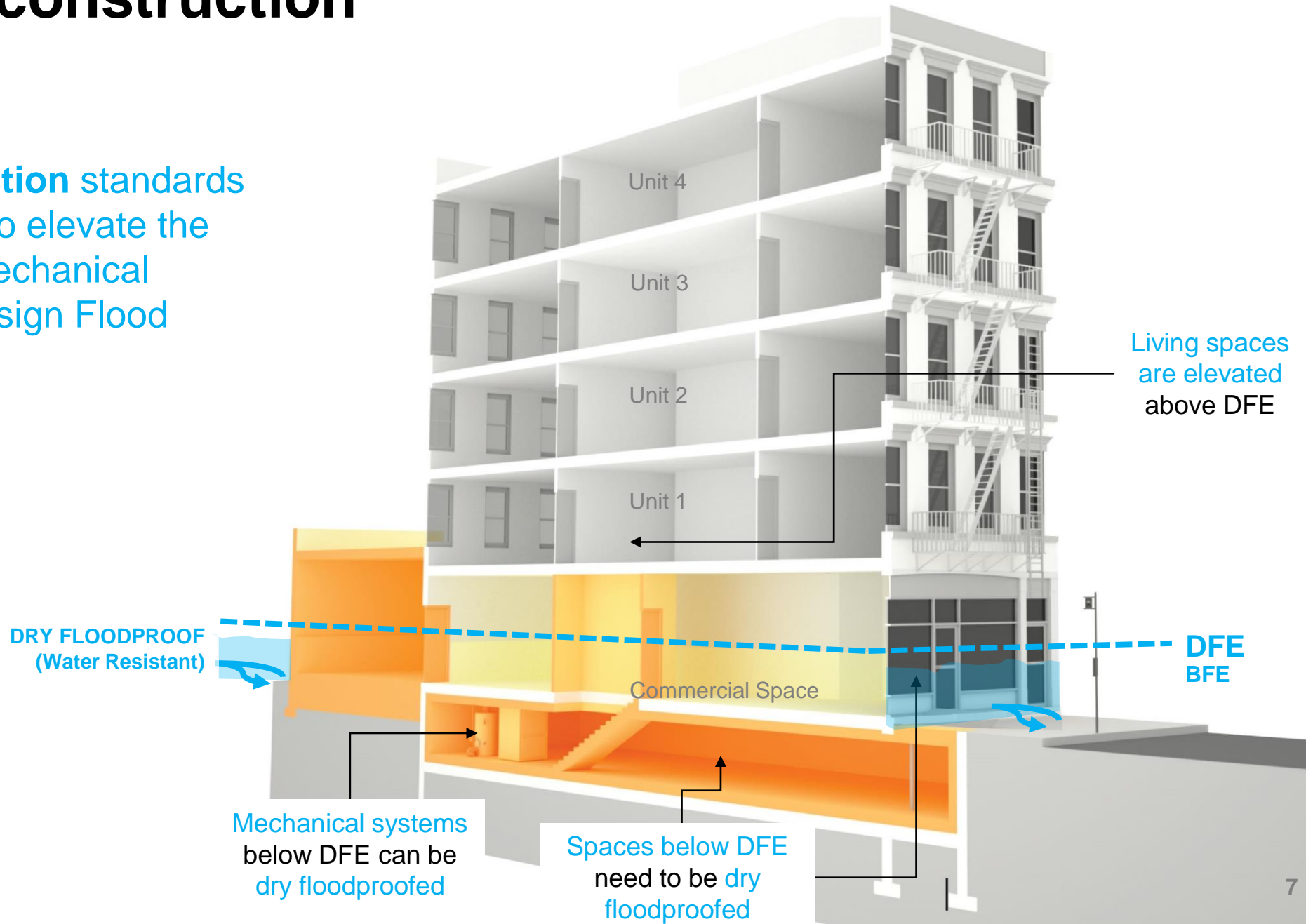

Flood resilient construction

Required by DOB

Required
for all new buildings



Not required for existing buildings
(unless substantially damaged or improved)

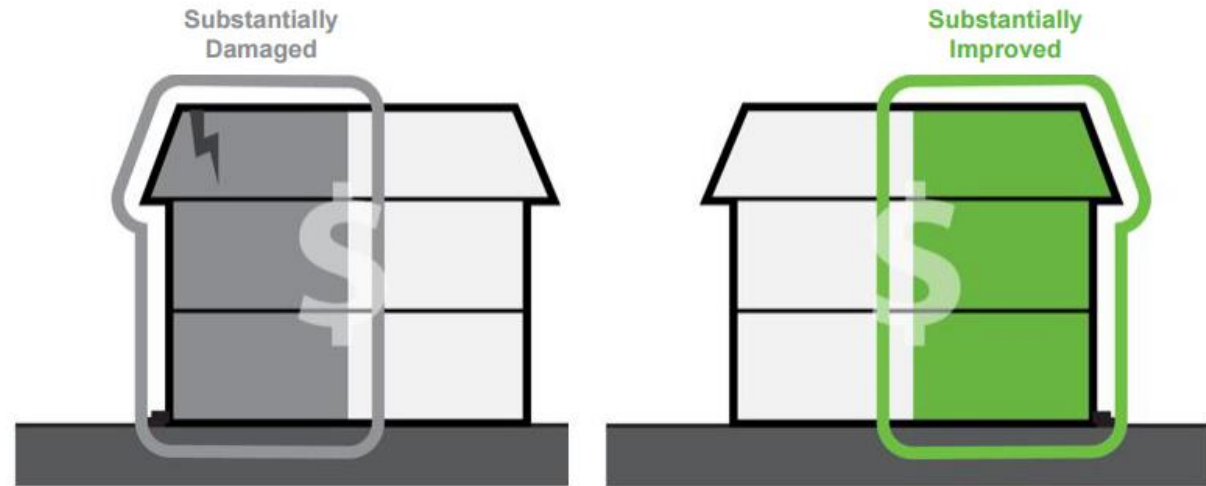

Flood Resilience Zoning Projects at DCP

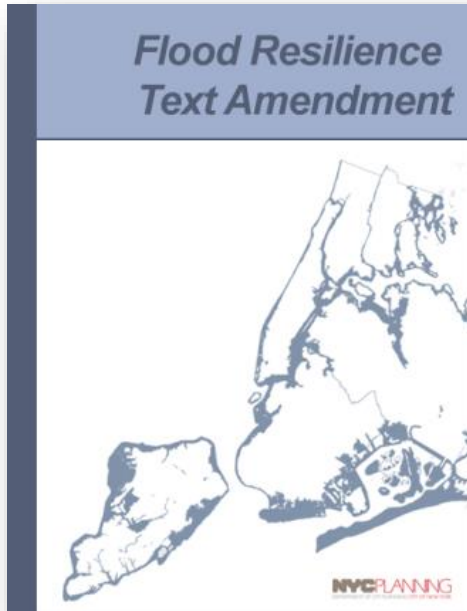

2013

“Flood Text”

initial temporary regulations
to facilitate recovery

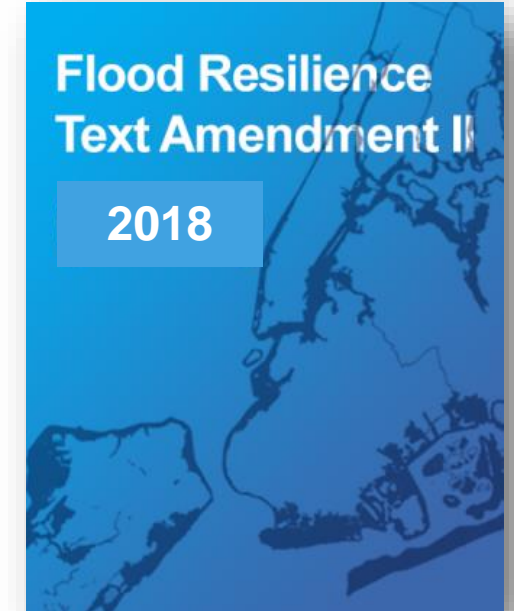
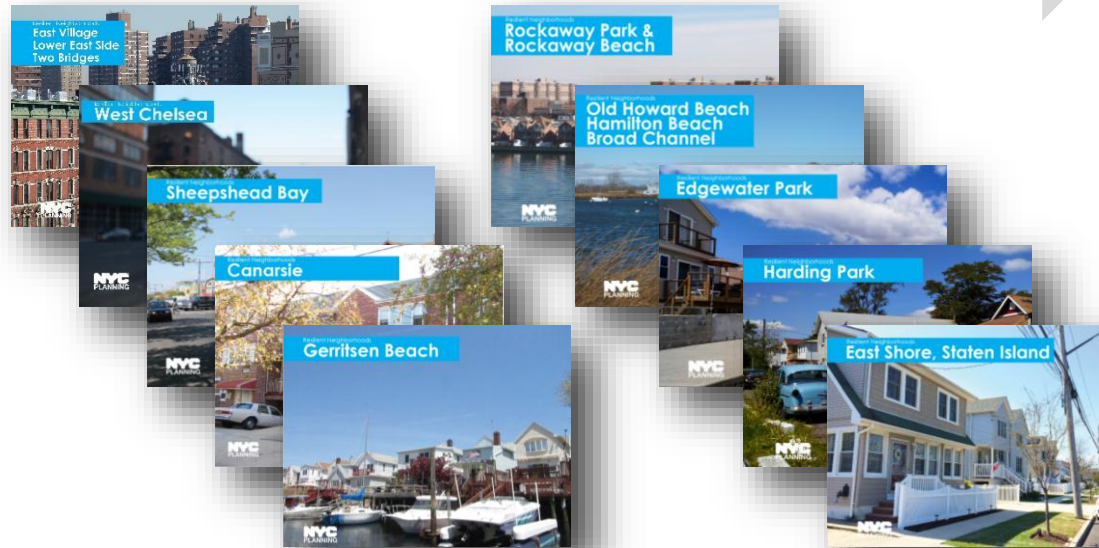
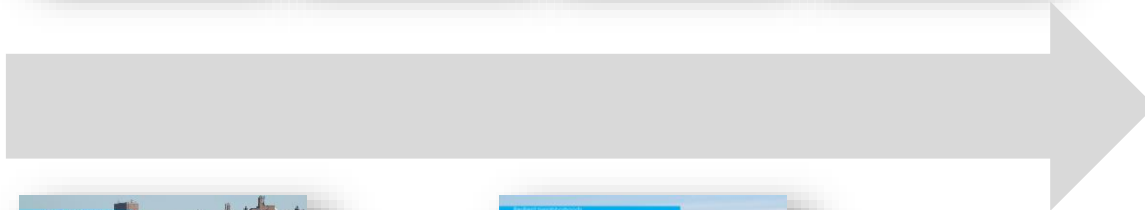
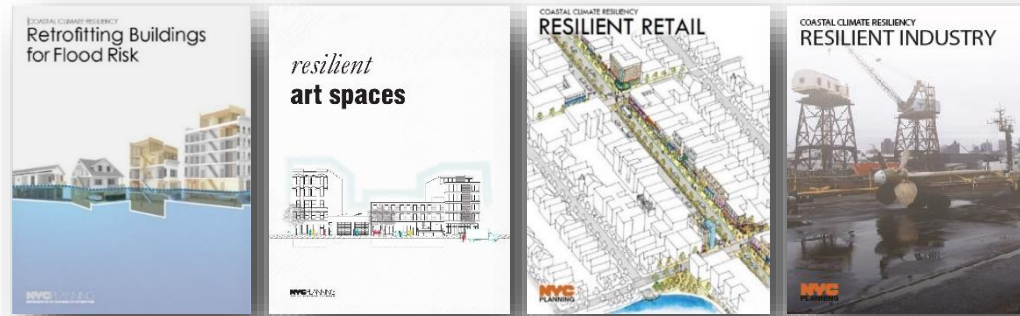

2018

“Flood Text Update”

improve upon, and make
permanent, the Flood Text

2013 Citywide Flood Text

Amended zoning in six key areas

1
Height
Measured from
flood elevation

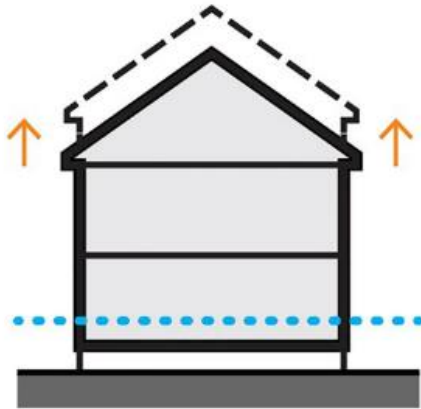

2
Access
Flexibility for
stairs, ramps, lifts

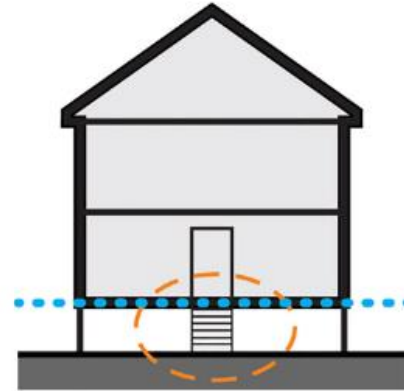

3
Parking
Flexibility to
relocate parking

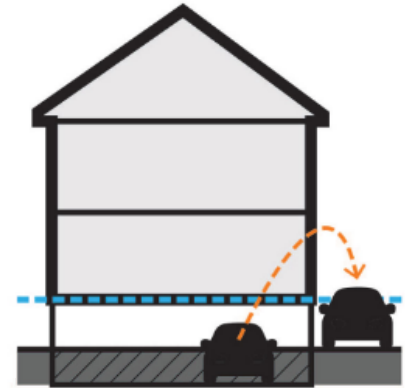

4
Systems
Flexibility to
relocate/elevate

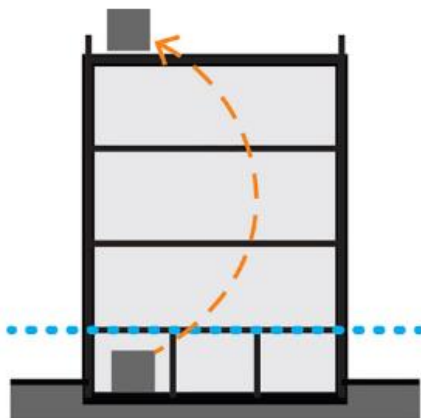

5
Ground Floors
Account for costs
of new flood risk

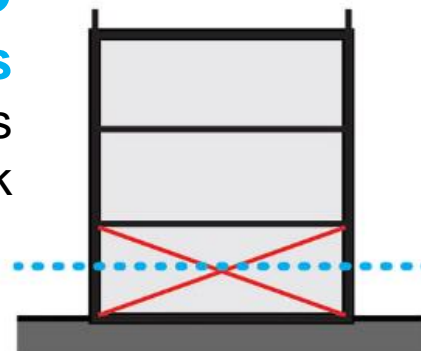

6
Streetscape
Require features to
mitigate blank wall

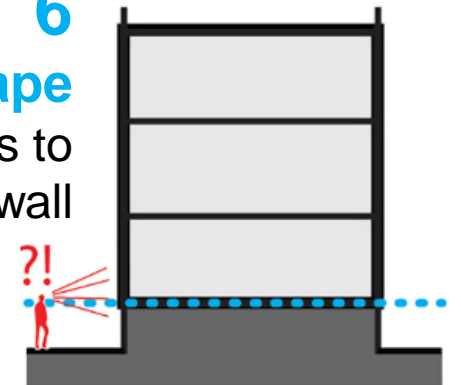

Lessons learned since 2013

Encouraging resilient construction

Based on these filings, only 1,600 (2%) of the 71,000 buildings in the floodplain will be fully flood resilient.

The zoning relief we provided may not be achieving our goal of increasing code-compliant, flood-resistant projects.

DOB Permit Filings

in the flood hazard area, 10/2013 – 1/26/2016

New buildings

100%

1,021 of 1,021

meet full resiliency standards

149 (14%) approved
451 (44%) underway
179 (17%) complete

25% rejected/pending

Major alterations (Alt-1)

10%

113 of 1,090

meet full resiliency standards

36 (31%) approved
24 (21%) underway
0 (0%) complete

48% rejected/pending

Minor alterations (Alt-2)

3%

532 of 15,573

meet full resiliency standards

245 (46%) approved
122 (23%) underway
9 (1%) complete

30% rejected/pending

Flood Text Update

Need for a new citywide text amendment



1

Make the provisions of the current, temporary 2013 Flood Text **permanent**

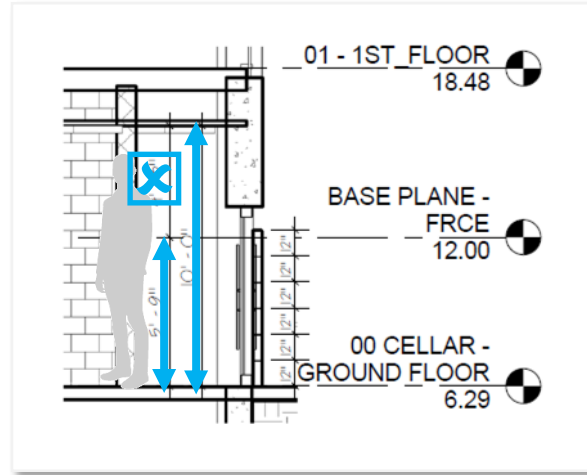

2

Fix and improve provisions based on studies, lessons learned, and outreach

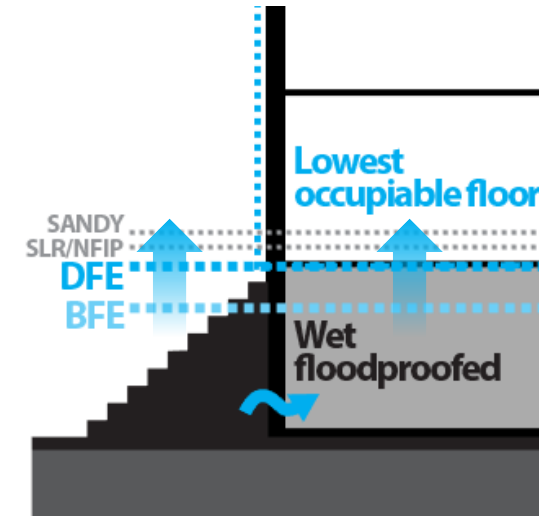

3

Begin to **promote** new development + proactive retrofitting to high resiliency standards

Flood Text II

Fix and improve provisions based on lessons learned

1

Height

Homeowners may face the loss of subgrade spaces when retrofitting

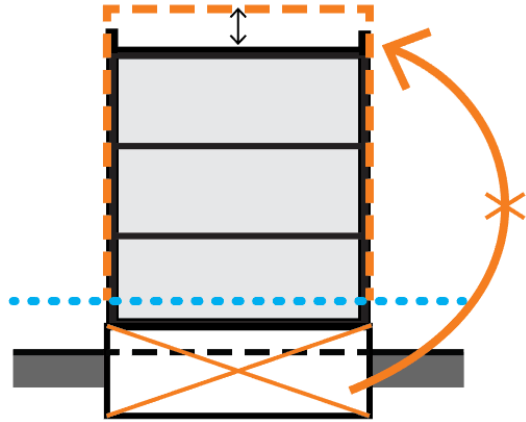

2

Height

Properties owners may want to address future risk by over-elevating

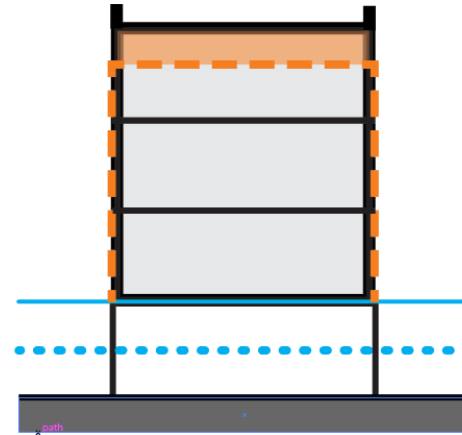

3

Ground Floors

Current incentives to keep active ground floors may not be enough

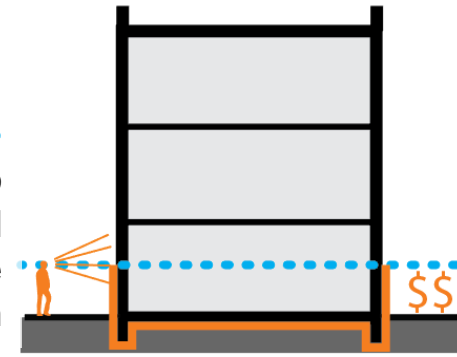

Height – loss subgrade spaces

Improvements and lessons learned

ISSUE

The 2013 Flood Text doesn't provide a solution for non-raisable building typologies:

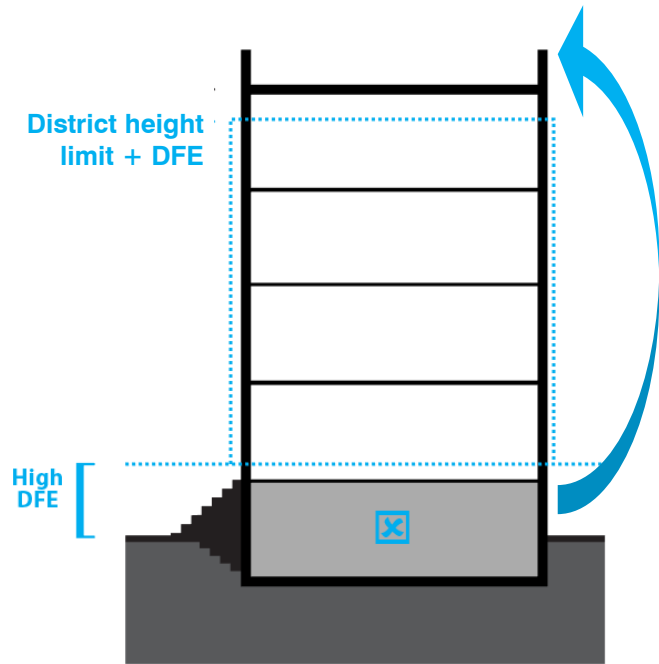

Old Non-Complying Building with high DFE

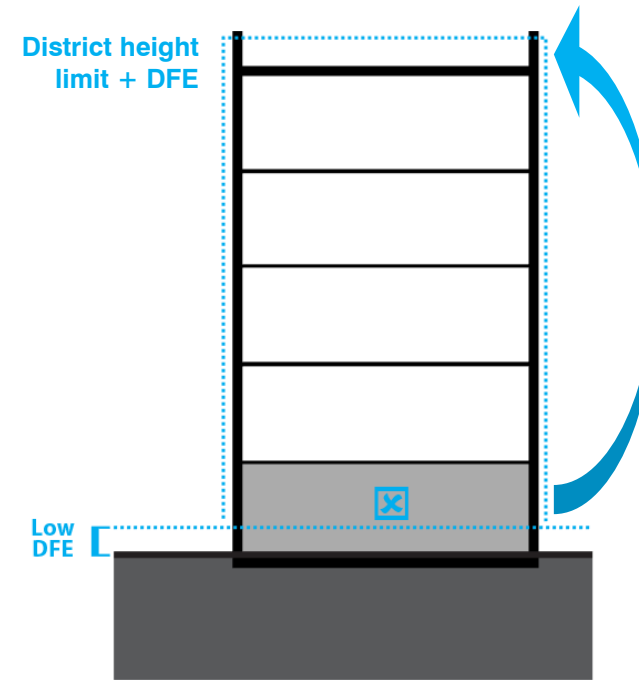

Complying Buildings with low DFE

1
Height
Homeowners may face the loss of subgrade/at grade spaces when retrofitting

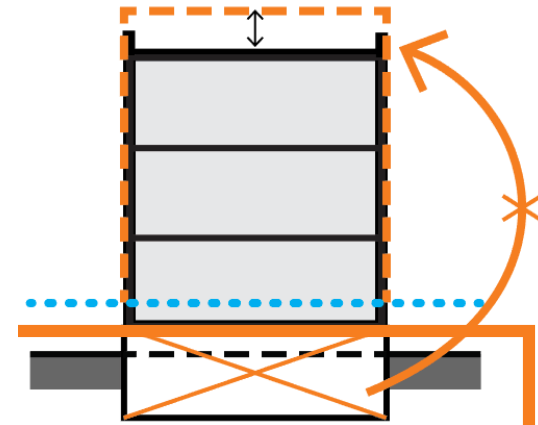

Height – long term resiliency

Improvements and lessons learned

ISSUE

The 2013 Flood Text allowed for zoning envelopes to be adjusted to the height of the flood elevation. Although, it may still prevent certain access solutions in “packed” envelopes, and it may discourage long-term planning:

2

Height

Properties owners may want to address future risk by over-elevating

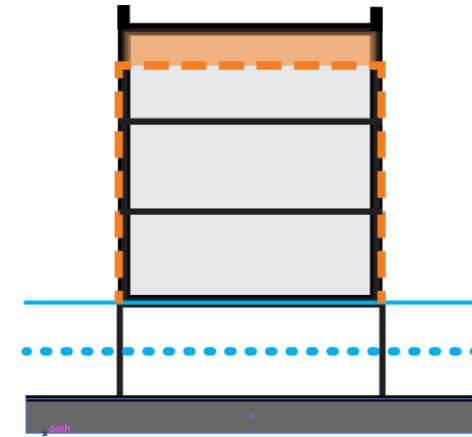

Without bump-up

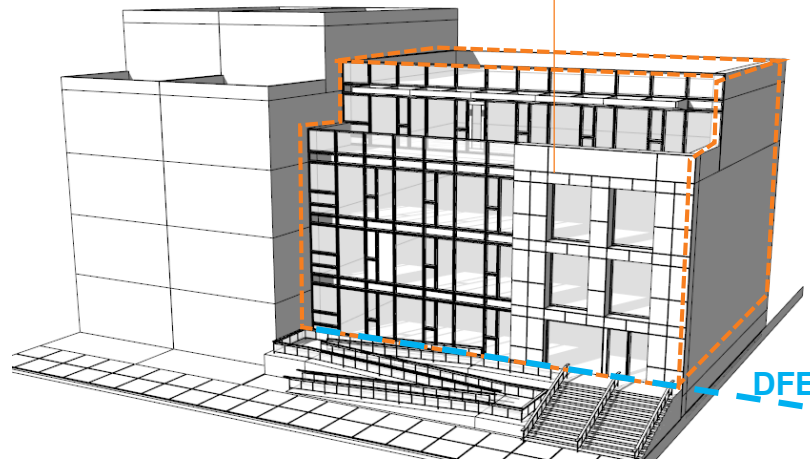

With bump-up

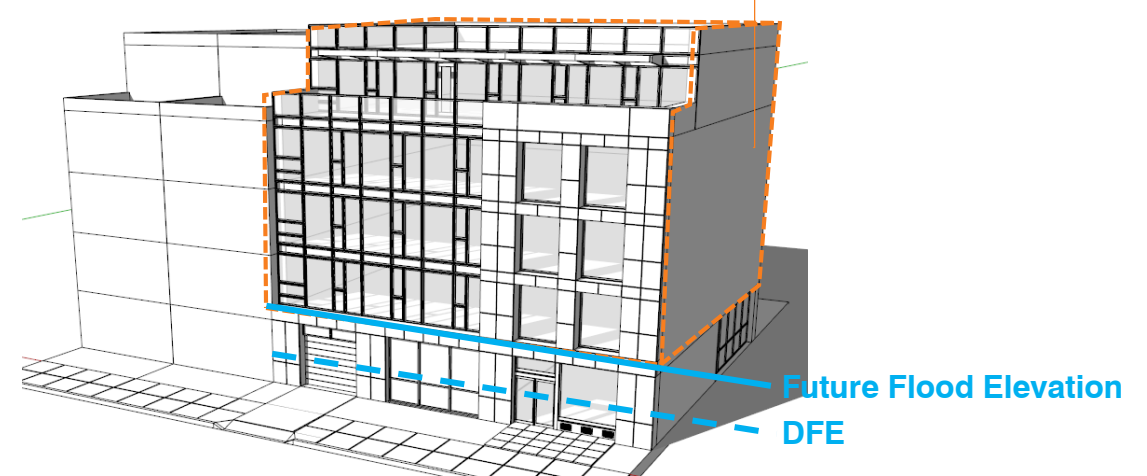

Commercial Ground Floors

Improvements and lessons learned

ISSUE

- Bad urban design outcomes due to “squishing” – dark, low-ceilinged establishments.
- Causes lower-grade commercial stock, limits the types of retail tenants and services that can locate in the building, such as restaurants.
- Doesn't apply to at least half of the floodzone.
- Doesn't create a zoning incentive to prefer **dry floodproofing** implementations over wet floodproofing (active over passive).

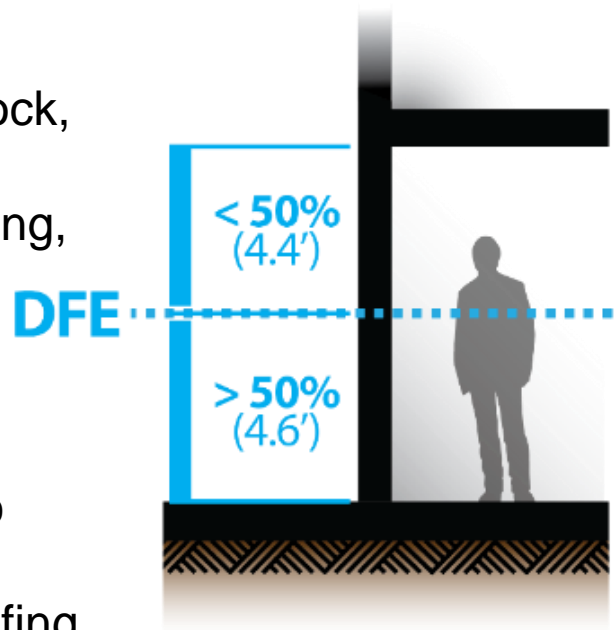

Above-grade cellar in the flood zone

3 Ground Floors

Current incentives to keep active ground floors may not be enough

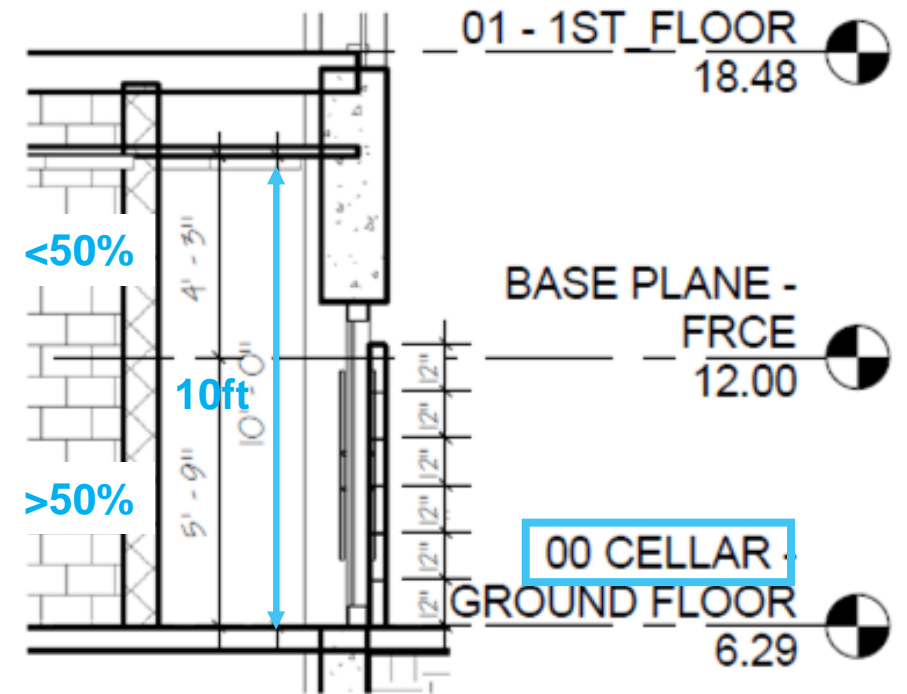
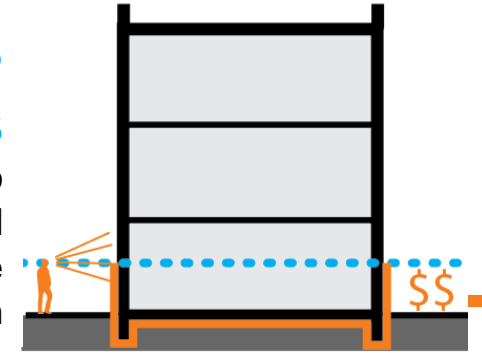

Example of ‘squished’ retail (1809 Emmons Ave., BK)

Flood Text Update Outreach

DCP plans a robust public engagement process:

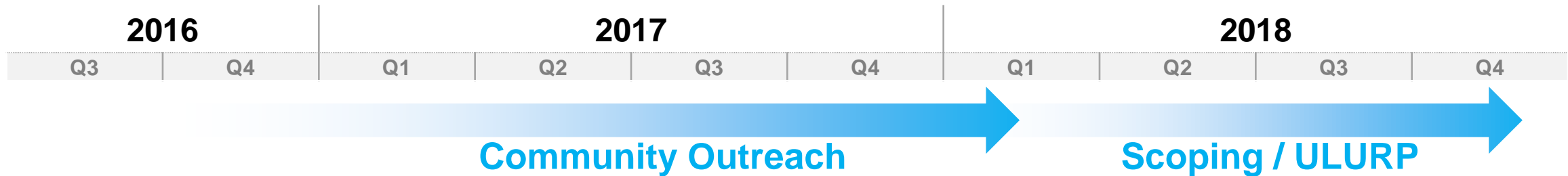

As part of this outreach process, DCP will:

- **Partner with stakeholders** to educate and promote awareness of flood risk and resiliency issues
- **Explain how zoning tools** relate to resiliency
- **Explore unique neighborhood issues** through in-depth public presentations and workshops
- Develop a proposal through an **iterative process** that is shaped by feedback

* Schedule is tentative and subject to change

Outreach Resources



NYC Flood Hazard Mapper

www.nyc.gov/floodhazardmapper

Info briefs on Flood Resilience Zoning, Flood Risk, Flood Resilient Construction, and Flood Insurance

www.nyc.gov/resilientneighborhoods



NYC PLANNING Info Brief Flood Insurance

Flood insurance covers damages to property or personal contents from flooding caused by excessive rainfall, tidal flooding, or wind-driven storm surges. Changes to flood maps and reforms to the National Flood Insurance Program will lead to increases in flood insurance rates over time. In addition to flood resilient construction, insurance is another strategy for reducing flood risk.

Why is Flood Insurance Important?

- Floods can cause significant damage to your most valuable asset: your business.
- Even properties far from the coast are at risk of flooding.
- Homeowner and property insurance cover damage by flooding. You need a separate policy.
- Federal assistance is not guaranteed in the event of a flood.
- Many property owners are required by federal law to purchase and maintain flood insurance if the property is located in a high-risk flood zone of the 2007 FIRM (see map to the right), has a federally backed mortgage, or has received federal disaster assistance.

How Much Flood Insurance Must a Homeowner Purchase?

Properties with a federally backed mortgage in a high-risk flood zone and those that have received federal disaster assistance must maintain flood insurance up to the National Flood Insurance Program (NFIP) limits, or the outstanding mortgage balance, whichever is lower. Failure to do so may require mortgage servicers to purchase a policy for the property—possibly at a higher price—on the cost through monthly mortgage payments.

Homeowners without a federally backed mortgage or outside a high-risk flood zone can carry up to the maximum policy limit with additional contents coverage up to \$100,000 for owners or renters. Co-tenanted multifamily buildings and business properties can be covered up to \$500,000. Business and tenants can also purchase up to \$500,000 in contents coverage.

NYC Planning | November 2016

NYC PLANNING Info Brief Flood Risk in NYC

New York City is highly vulnerable to flooding from coastal storms due to its intensively used waterfront and its extensive coastal geography. Floods have the potential to destroy homes and businesses, impair infrastructure, and threaten human safety. With climate change and sea level rise, these risks are expected to increase in the future, but will most adversely affect low-lying neighborhoods.

Flood Risks

Hurricanes, tropical storms, nor'easters, intense rain storms, and even extreme tides are the primary causes of flooding in NYC.

For building code, zoning, and planning purposes, flood risk in NYC is represented on FEMA's 2015 Preliminary Flood Risk Rate Maps (PFIRMs).

- PFIRMs show the extent to which floodwaters are expected to rise during a storm event that has a 1% annual chance of occurring. This height is denoted as Flood Elevation (BFE) on the maps.
- The 1% annual chance floodplain, sometimes referred to as the 100-year floodplain. However, this term is used since these floods can occur multiple times within 100 years. In the 1% annual chance floodplain, there is a 26% chance over the life of a 30-year mortgage.

For flood insurance purposes, the 1% annual chance floodplain with a federally backed mortgage are mandated by law to purchase flood insurance.

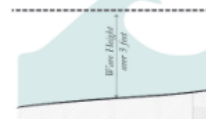

The 1% annual chance floodplain is divided into different degrees of flood risk: V and Coastal Flood Risk. The areas with a lower annual chance of flooding are shown in lighter shades.

NYC Planning | November 2016

NYC PLANNING Flood Resilience Zoning www.nyc.gov/resilientneighborhoods

City Planning is working with communities throughout the floodplain to identify zoning and land use strategies to reduce flood risks and support the city's vitality and resiliency through long-term adaptive planning. The Flood Resilience Zoning Text is one part of a wide range of efforts by the City to recover from Hurricane Sandy, promote rebuilding, and increase the city's resilience to climate-related events.

Overview

The Flood Text enables and encourages resilient building construction through designated floodplains.

The Flood Text modified zoning to regulate building construction through the reconstruction of storm-damaged buildings with new, higher flood elevations issued by the Federal Emergency Management Agency (FEMA), and to comply with new requirements of the New York City Building Code.

It also introduced regulations to mitigate negative effects of flood resilient construction on the public realm. The text was adopted on a temporary, emergency basis. The future update of this text, guided by community input, will aim to make the text permanent and incorporate lessons learned during the reconstruction process.

Where is the Flood Text Applicable?

The Flood Text is available to buildings located entirely or partially within an annual chance floodplain.

These rules can be found in Article V of the Zoning Resolution and, if utilized, require the building to fully comply with resilient construction standards found in the New York City Building Code. Some provisions, such as elevation certificates, are available to all buildings in the floodplain, even if not fully compliant with Appendix G.

For more information about the Flood Resilience Zoning Text, visit www.nyc.gov/resilientneighborhoods.

NYC Planning | March 2017 | Flood Resilient Construction

NYC PLANNING Info Brief Flood Resilient Construction

Flood resilient construction reduces potential damages from flooding and can lower flood insurance premiums. New buildings in the floodplain are required to meet flood resilient standards. Existing buildings can reduce their risk by retrofitting or rebuilding to meet these standards, or can take partial, short-term measures to address safety concerns.

Overview

There is a wide range of accepted flood resilient construction practices for buildings to better withstand floods and recoupy more quickly following a storm. These include:

- Elevating the lowest floor.
- Elevating mechanical equipment such as electrical, heating, and plumbing equipment.
- **Wet floodproofing** by utilizing water resistant building materials and limiting uses below the Design Flood Elevation (DFE) to parking, building access, and minor storage. This allows water to move in and out of uninhabited, lower portions of the building with minimal damage.
- **Dry floodproofing** sealing the building's exterior to flood waters and using removable barriers at all entrances below the expected level of flooding in mixed-use and non-residential buildings.

Examples of Flood Resilient Construction

Visit www.nyc.gov/resilientneighborhoods to see more examples in the *Retrofitting for Flood Risk* report.

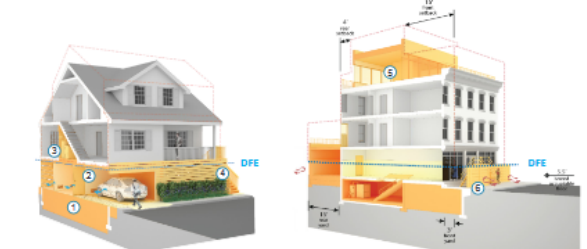

- ① Site is filled to the lowest adjacent grade
- ② Space below the DFE is for parking, building access or minor storage
- ③ Mechanical systems are above the DFE
- ④ Plants and stair turns improve the look of the building from the street
- ⑤ Rooftop addition replaces lost below grade space
- ⑥ Commercial space is dry floodproofed with removable barriers

NYC Planning | November 2016 | Flood Resilient Construction



Thank you!

For more information, and to stay involved, email
resilientneighborhoods@planning.nyc.gov

Appendix

Flood insurance rates

Set by FEMA



Raising or retrofitting your building or home will reduce costs

FEMA's flood insurance premiums are lowest when the lowest inhabited floor (any area not used solely for storage, access or parking) is elevated above the **Base Flood Elevation (BFE)**.

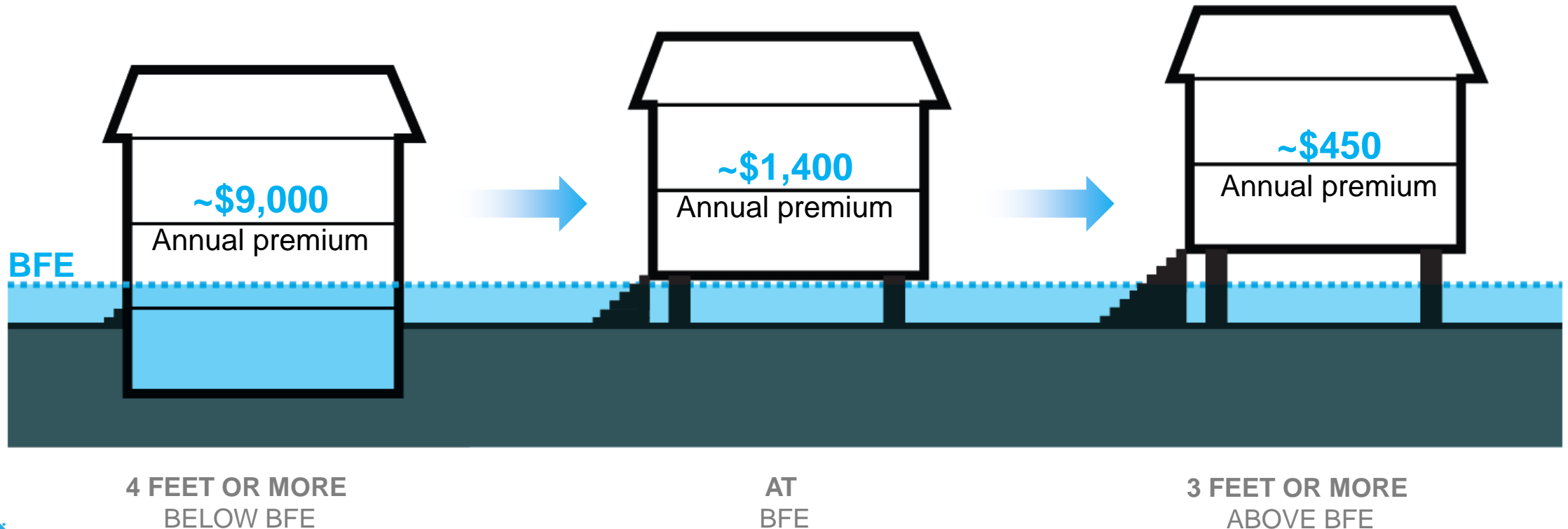

FIRM vs. PFIRM

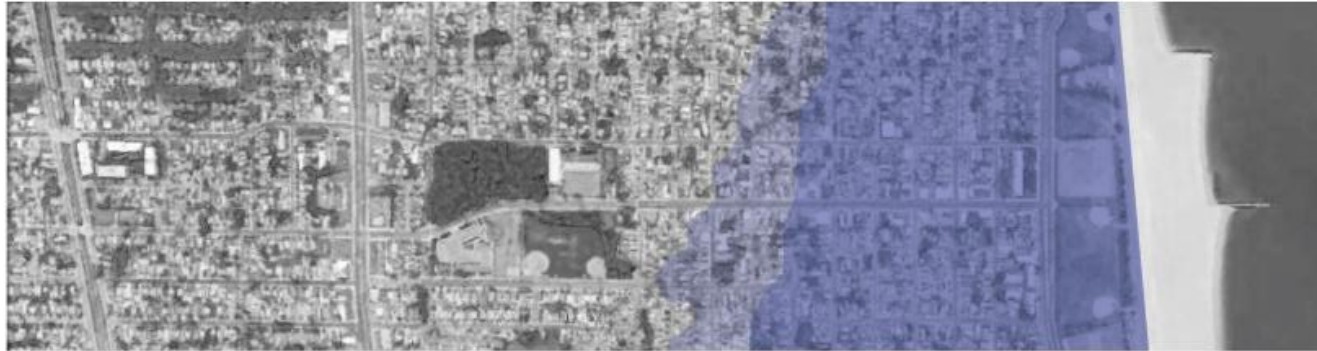

FIRM

1983; digitized 2007
Currently used for
flood insurance purposes



PFIRM

2013, revised 2015
Currently used for
building code purposes

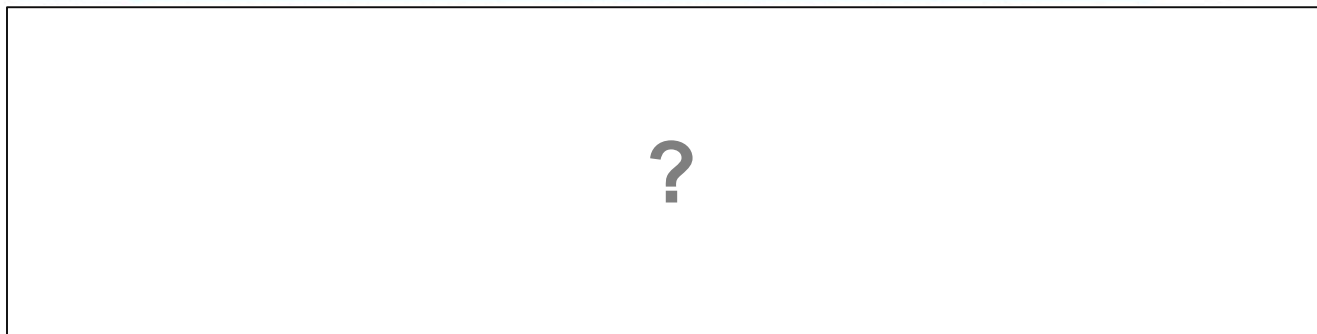

Post-appeal PFIRM

Expected 2019+
Affected geography unknown

Not actual map – illustrative only

Flood Text II

Fix and improve provisions based on lessons learned

1

Height

Homeowners may face the loss of subgrade/at grade spaces when retrofitting

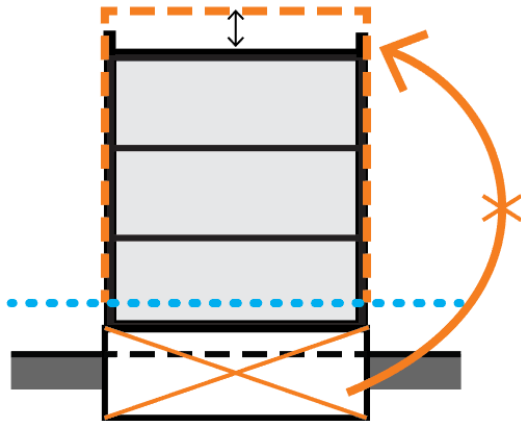

2

Height

Properties owners may want to address future risk by over-elevating

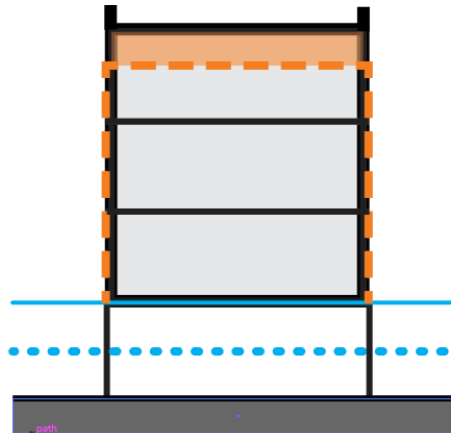

3

Ground Floors

Current incentives to keep active ground floors may not be enough

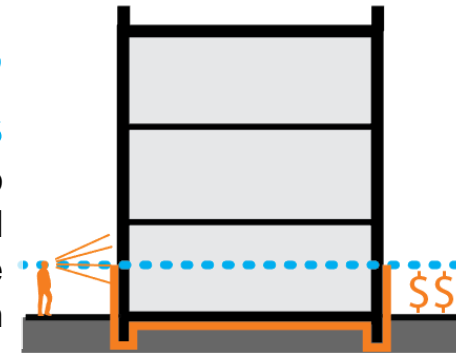

Height Improvements and lessons learned

ISSUE

The 2013 Flood Text doesn't provide a solution for non-raisable building typologies:

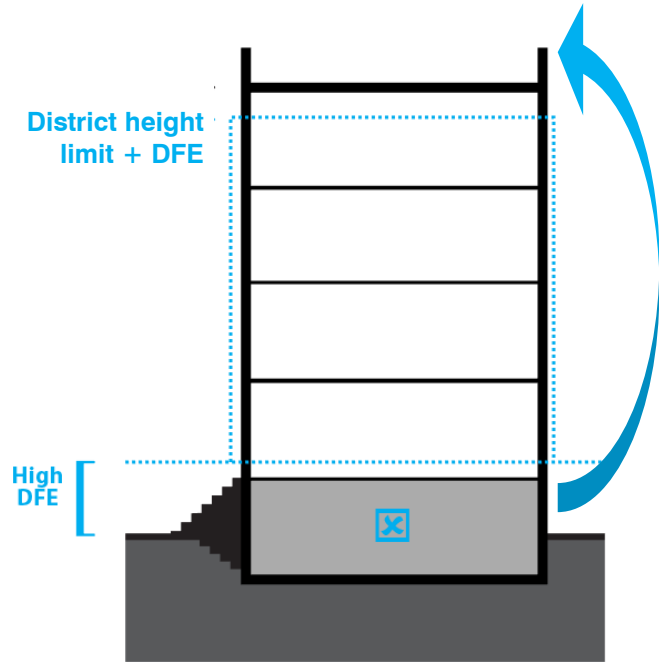

Old Non-Complying Building with high DFE

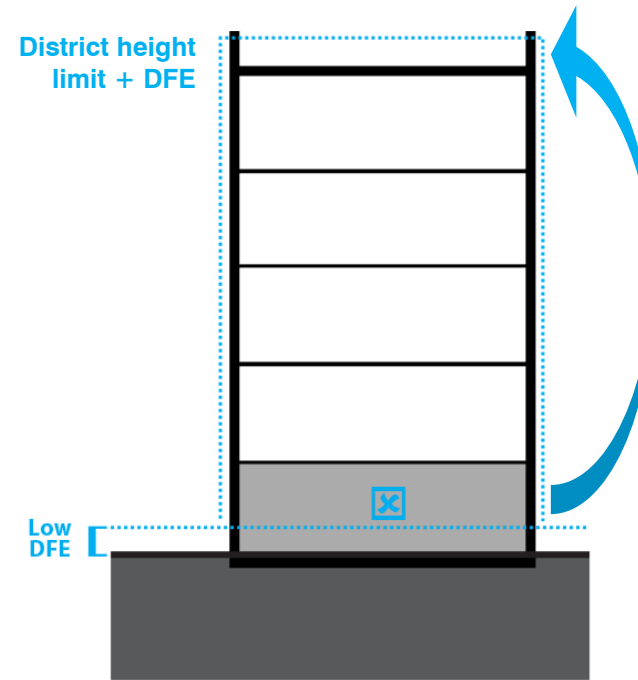

Complying Buildings with low DFE

1 Height
Homeowners may face the loss of subgrade/at grade spaces when retrofitting

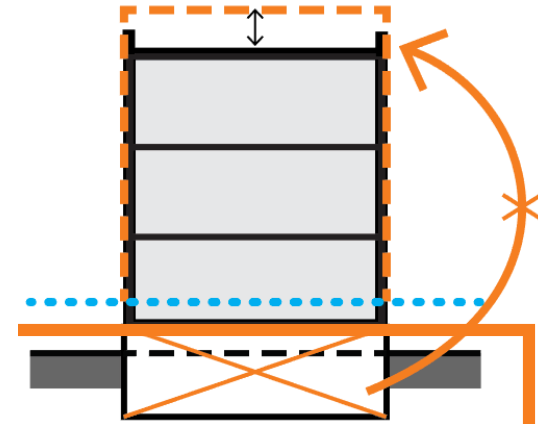

Height Improvements and lessons learned

ISSUE

The 2013 Flood Text allowed for zoning envelopes to be adjusted to the height of the flood elevation. Although, it may still prevent certain access solutions in “packed” envelopes, and it may discourage long-term planning:

Without bump-up

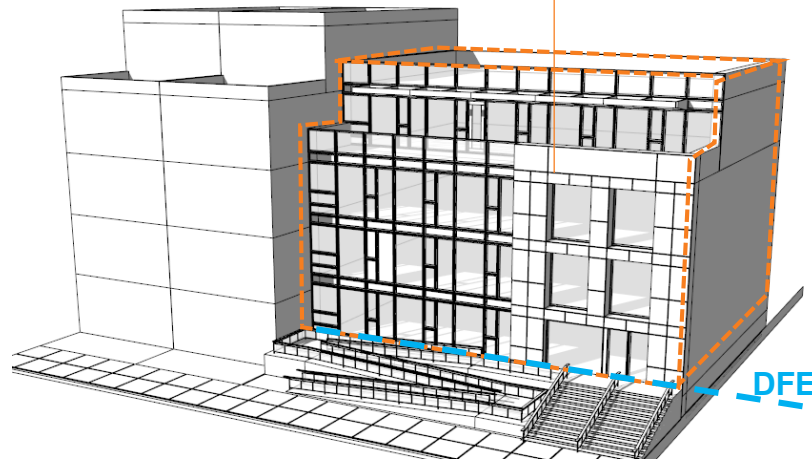

2 Height

Properties owners may want to address future risk by over-elevating

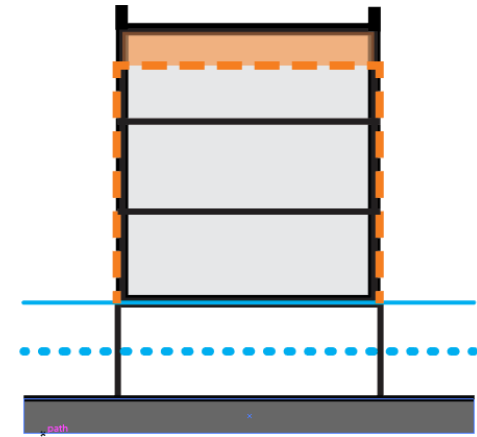

With bump-up

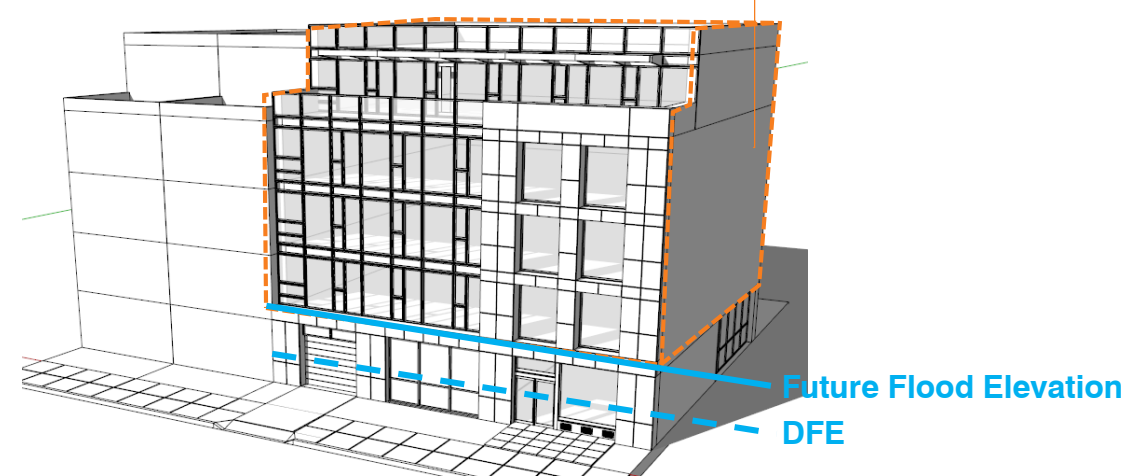

Commercial Ground Floors

Improvements and lessons learned

ISSUE

- Bad urban design outcomes due to “squishing” – dark, low-ceilinged establishments.
- Causes lower-grade commercial stock, limits the types of retail tenants and services that can locate in the building, such as restaurants.
- Doesn't apply to at least half of the floodzone.
- Doesn't create a zoning incentive to prefer **dry floodproofing** implementations over wet floodproofing (active over passive).

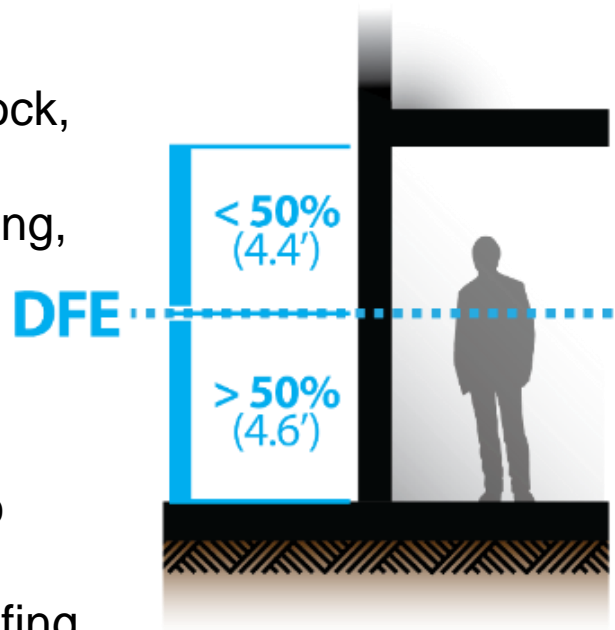

Above-grade cellar in the flood zone

3 Ground Floors

Current incentives to keep active ground floors may not be enough

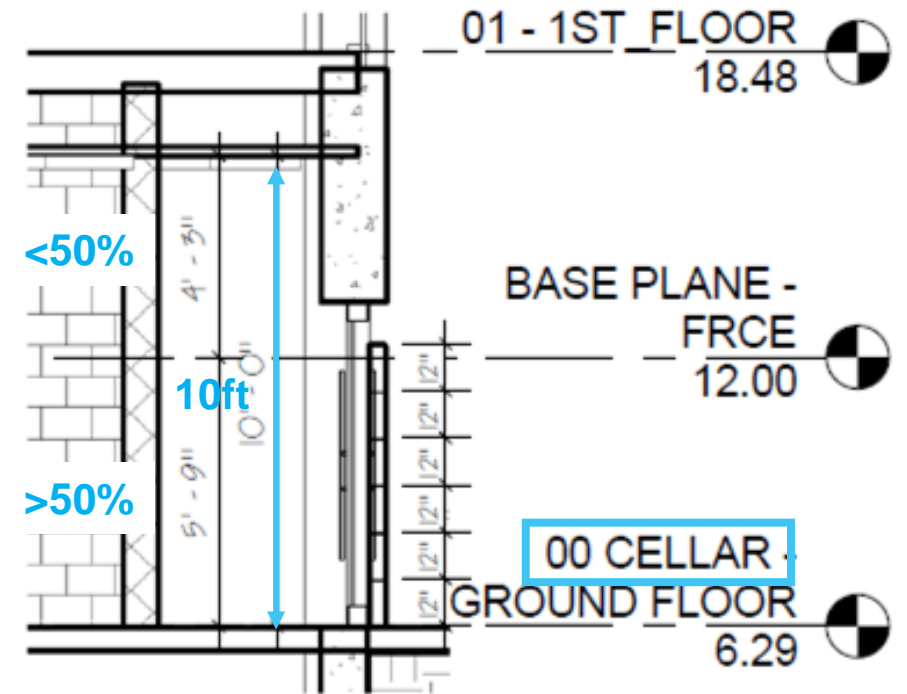
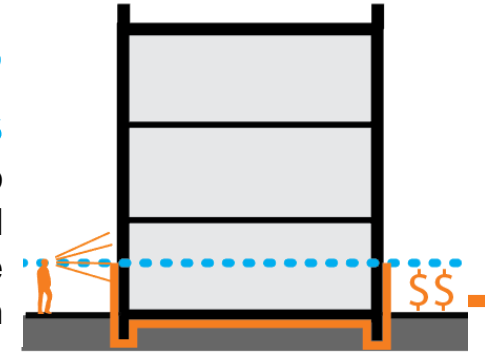

Example of ‘squished’ retail (1809 Emmons Ave., BK)