

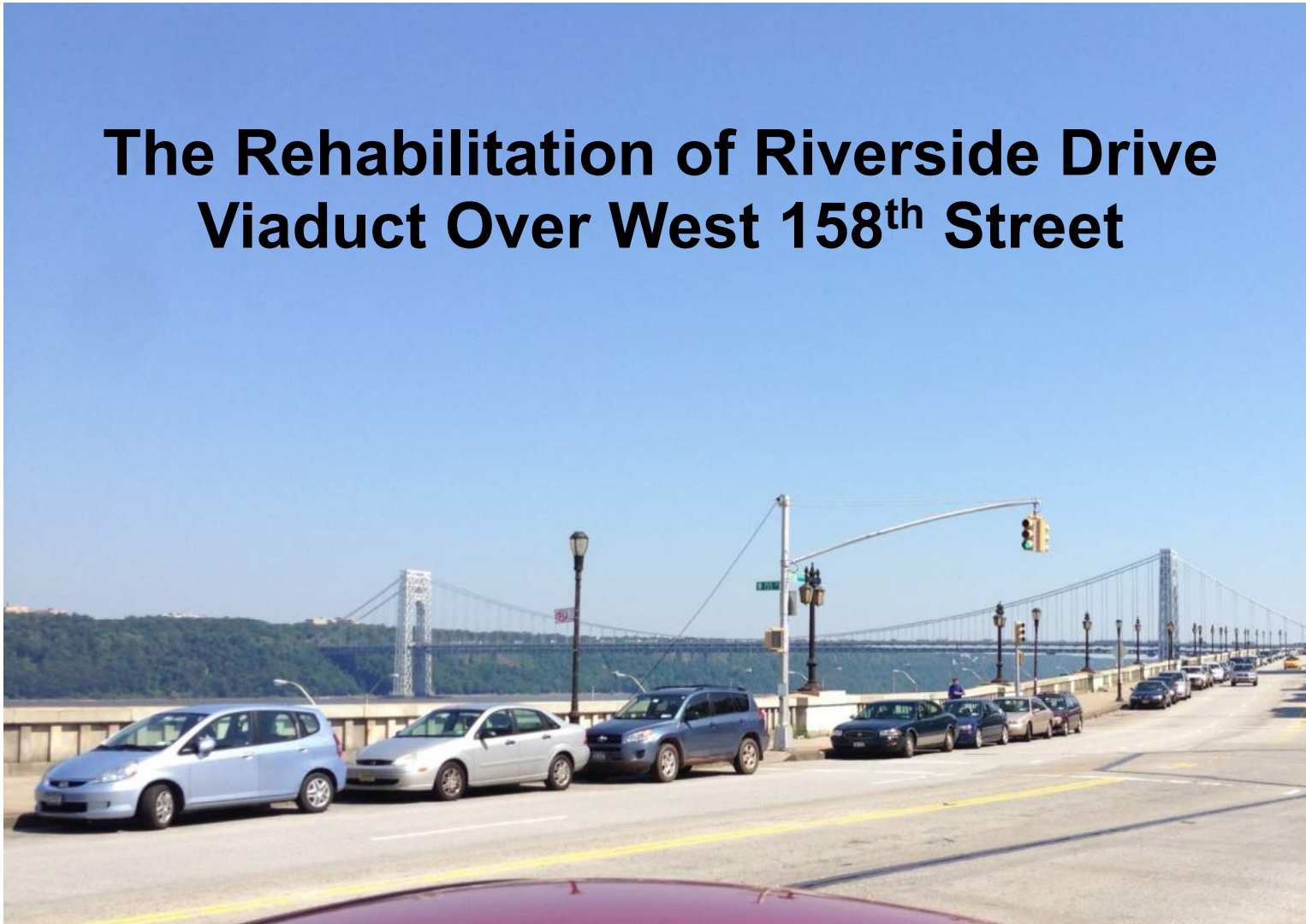

The Rehabilitation of Riverside Drive Viaduct Over West 158th Street



NYCDOT
Contract No.
HBM1165
BIN 2-24672-0

Town Hall Meeting
February 25, 2019

Project History



Original Construction

- Cantilever Section (Along Trinity Cemetery) – 1908
- Bent Section – 1927

Last Rehabilitation - 1985



Community Outreach



During Design

- Community Boards 9 & 12
 - October 2016
 - May 2018
- Councilmember Levine – July 2018

During Construction

- Meetings in February 2019

Outreach Platforms

- Twitter
- Facebook
- Internet Web Page
- Hardcopy Circulars



Valerie Torchon

Full Time Community Liaison

At Field Office

3801 Broadway, 2nd fl.

New York, NY 10032

Immediate Visible Construction Activities



Pre-Stage (East Sidewalk Bus Stop Construction) – March/April 2019

- 360 foot work zone in vicinity of W158th Street
- Bus stop temporarily relocated just to the south
- Parking lanes closed locally (24± spaces lost)
- 4 travel lanes maintained; 2 NB / 2 SB



Stage 1 – July/August 2019

- 1,820 foot work zone full length of Viaduct
- Parking lanes closed full length of Viaduct (185± spaces lost)
- 1 travel lane closed full length of Viaduct
- 3 travel lanes maintained; 2 NB / 1 SB

Project Need and Goal

- Need: Poor Deck Condition, Deteriorated Steel Members; Limited Remaining Life
- Goal: Restore Bridge Superstructure to a State of Good Repair



Project Limits

- Project Limits: W153rd to W161st Street
- Northern/Bent Section: W155th to W161st Street
- Southern/Cantilever Section: W153rd to W155th Street



Project Limits

- Project Limits: W153rd to W161st Street
- Northern/Bent Section: W155th to W161st Street
- Southern/Cantilever Section: W153rd to W155th Street



Project Limits

- Project Limits: W153rd to W161st Street
- Northern/Bent Section: W155th to W161st Street
- Southern/Cantilever Section: W153rd to W155th Street



Scope

Replace bridge deck and sidewalk; rehabilitation of steel framing, substructure repairs, bearing replacement, utilities; superstructure encasement removal, cleaning and painting steel

Construction

Construction is estimated to last 42 months

Est. Start: Winter 2018

Est. Finish: Summer 2022



Design Approvals

Landmarks – October 2016

SHPO – December 2017

Public Design Commission – July 2017

NYS DOT – March 2017

Interagency Coordination

Amtrak

Office of Construction Mitigation & Coordination

Street Lighting

NYCDEP (Drainage)

Private Utilities

NYPD

Sanitation Department

FDNY



Historic Elements

- Cast Iron Street Lamps
- Parapet Wall with Granite



Railing Replacement and Lighting



- Barrier Upgrade & New Lighting per NYCDOT Standards

Existing Condition
Steel Railing & Cobra Head
Lights



Final Condition
Texas Aesthetic
Barrier & Type M Poles

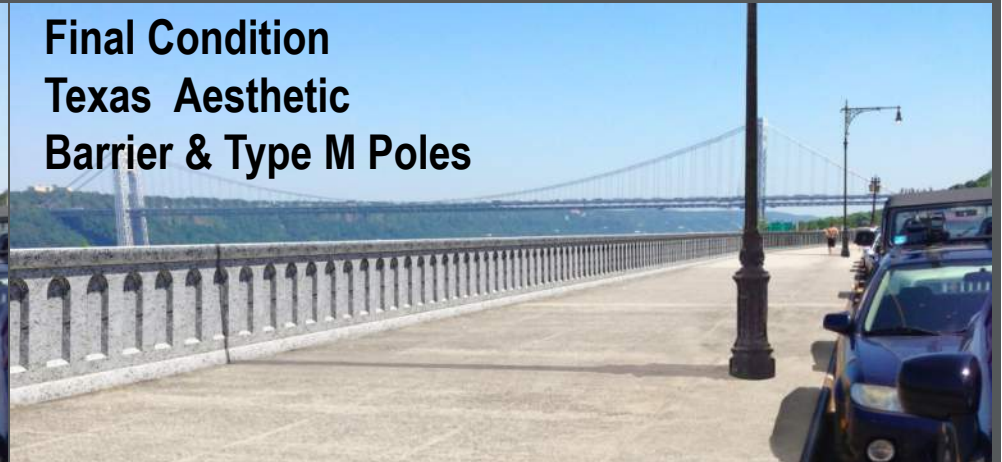

Southern Section of Bridge

Proposed Work Hours



- Daytime (Weekdays) for Majority of Work; Limited Weekends for Intersections
- Nighttime for Work Over Amtrak (Spring 2019 - Spring 2020)



Contractor Storage Area

- W155th St Dead End
- Cantilever Section Access Road

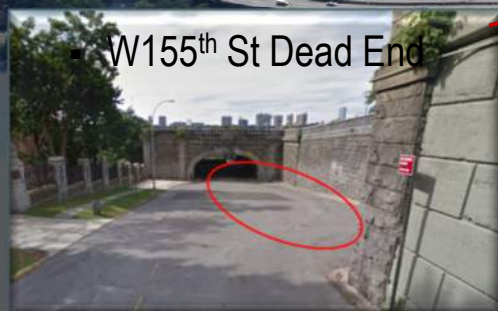

Environmental Impact during Construction



- **Noise**
 - Daytime construction operations
 - Compliance with DEP standards and NYC Local Law 113
- Vibrations
- Air quality
- Lead Paint
- Lighting



Environmental Impact during Construction



- Noise
- **Vibrations**
 - Preconstruction surveys
 - Vibration monitoring
 - Low vibration thresholds due to adjacent historic properties
- Air quality
- Lead Paint
- Lighting



Environmental Impact during Construction



- Noise
- Vibrations
- **Air quality (Emissions and Dust)**
 - Vehicles and equipment to comply with DEP standards and NYC Local Law 77
 - Use Tier II engines, ultra-low sulfur diesel fuels, and diesel particulate filters
- Lead Paint
- Lighting



Environmental Impact during Construction



- Noise
- Vibrations
- Air quality
- **Lead Paint**
 - Identified existing viaduct steel elements coating contains lead
 - Full containment with negative air during lead abatement
 - Comply with OSHA and US EPA regulations
 - Lead contaminated debris to be contained and disposed of at a US EPA approved landfill
- Lighting

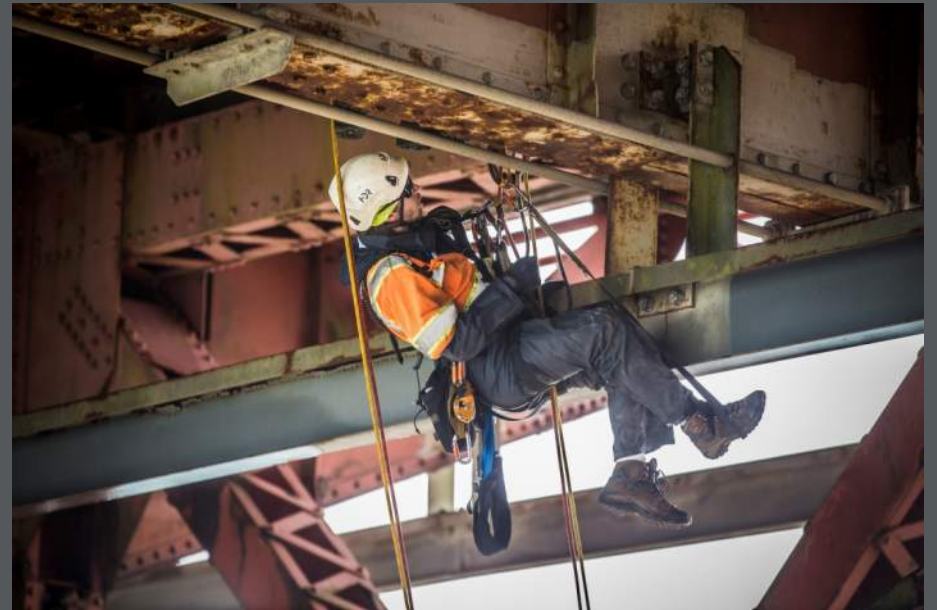

Environmental Impact during Construction



- Noise
- Vibrations
- Air quality
- Lead Paint
- **Lighting**
 - Temporary during construction; permanent at project completion
 - Maintain adequate lighting for entire project area
 - During construction temporary lighting to be mounted on barriers, including along sidewalks
 - Construction lighting directed away from residences



Work Zone Control Pre-Stage (Bus Turnout)



Work Zone Control Stage 1A

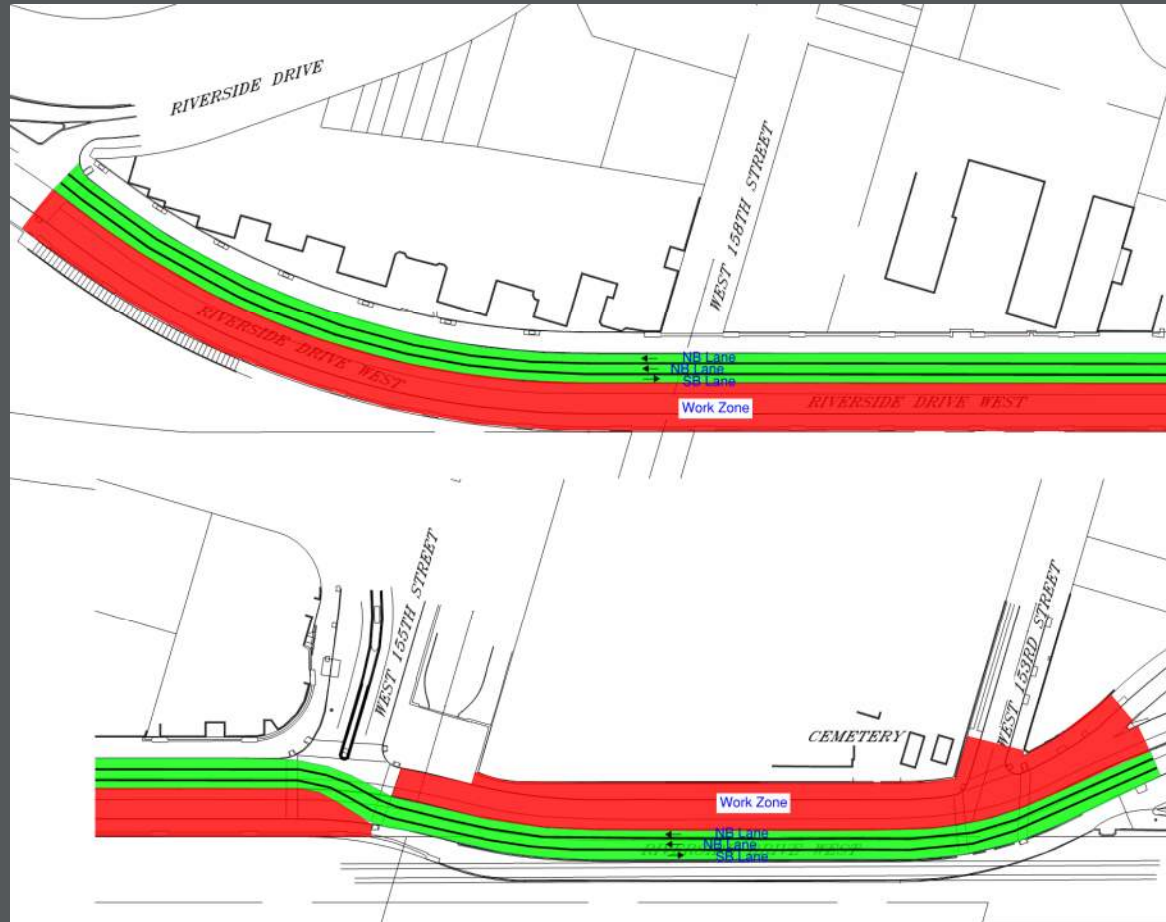

Work Zone Control Stage 1A

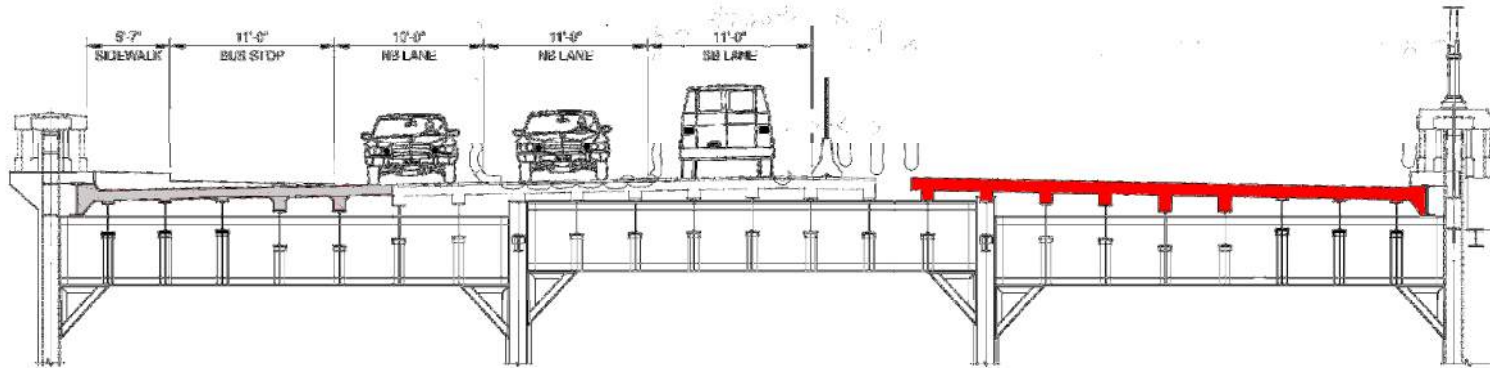

STAGE 1A AND 1B CONSTRUCTION LOOKING SOUTH - TYPICAL AT BENT STRUCTURE - NYPD AND NYCDOT GARAGE AREAS

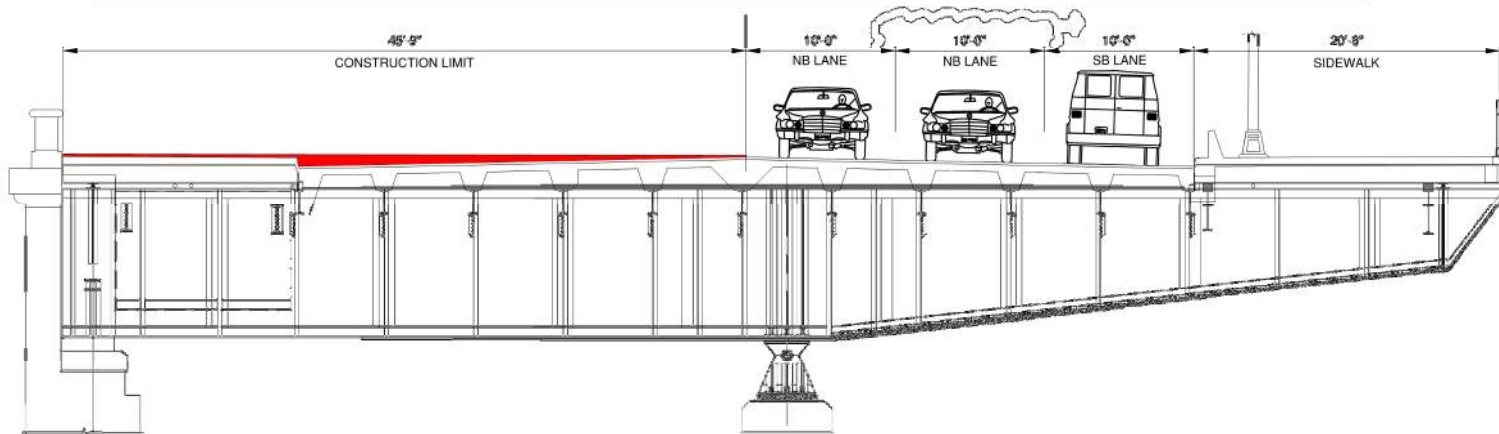

STAGE 1A PLACING TEMPORARY ASPHALT PAVEMENT LOOKING SOUTH - TYPICAL AT CANTILEVER STRUCTURE - AMTRAK AREA

Work Zone Control Stage 1B

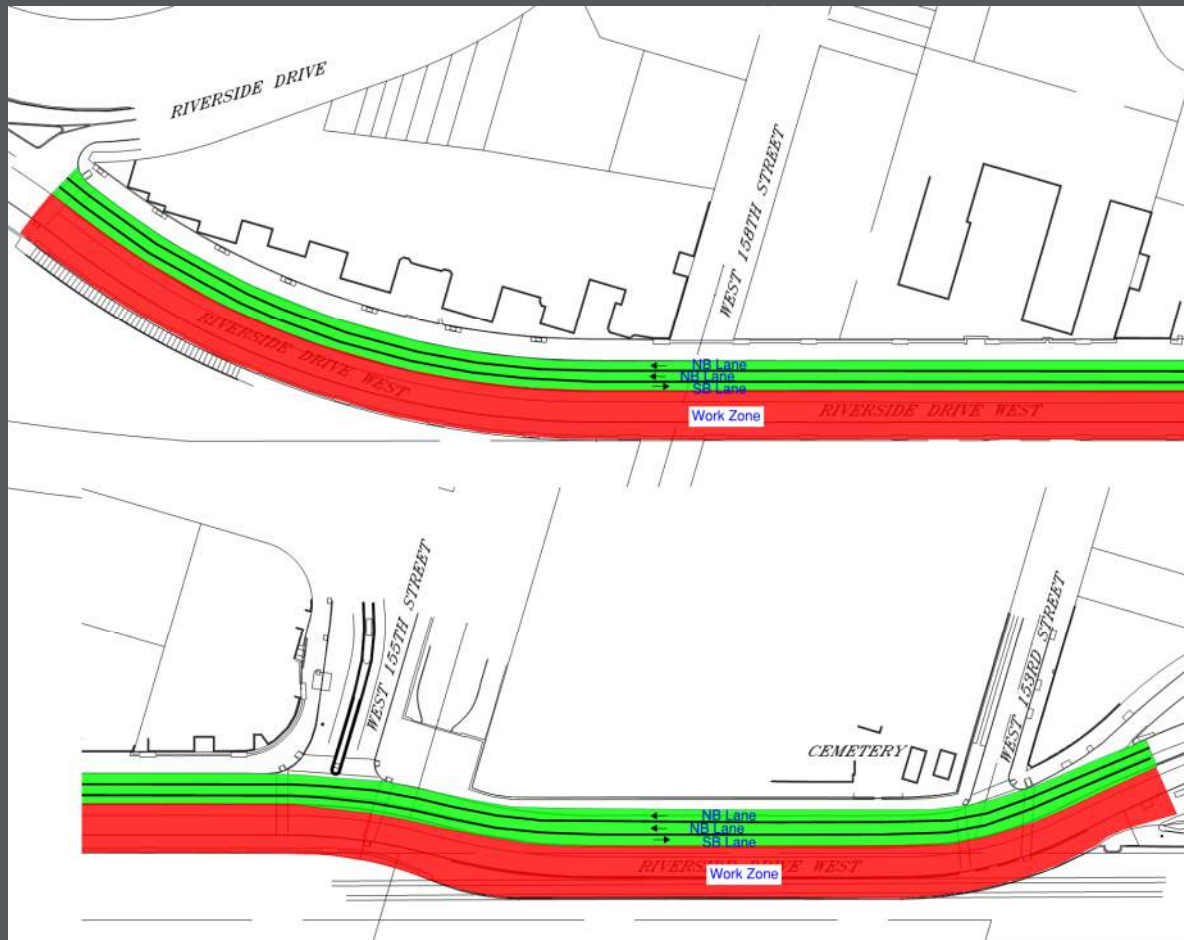

Work Zone Control Stage 1B

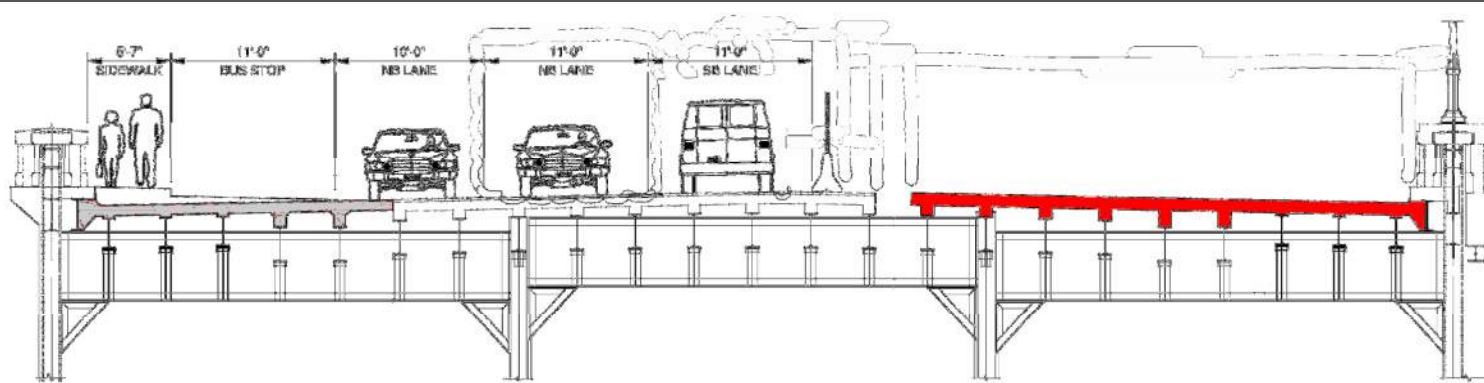

STAGE 1A AND 1B CONSTRUCTION LOOKING SOUTH - TYPICAL AT BENT STRUCTURE - NYPD AND NYCDOT GARAGE AREAS

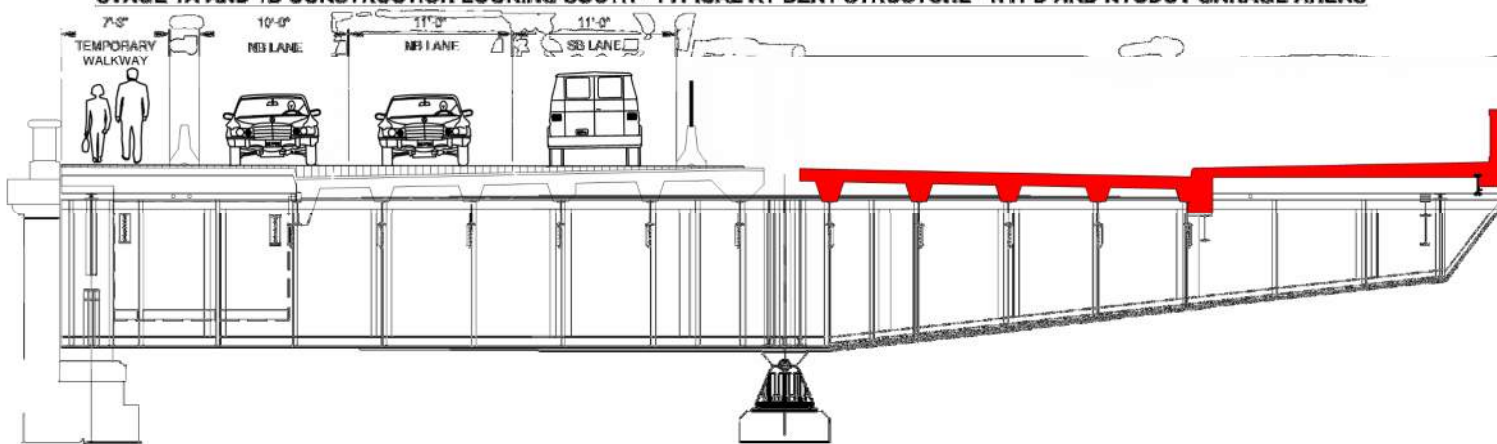

STAGE 1B CONSTRUCTION LOOKING SOUTH - TYPICAL AT CANTILEVER STRUCTURE - AMTRAK AREA

Work Zone Control Stage 2



Work Zone Control Stage 2

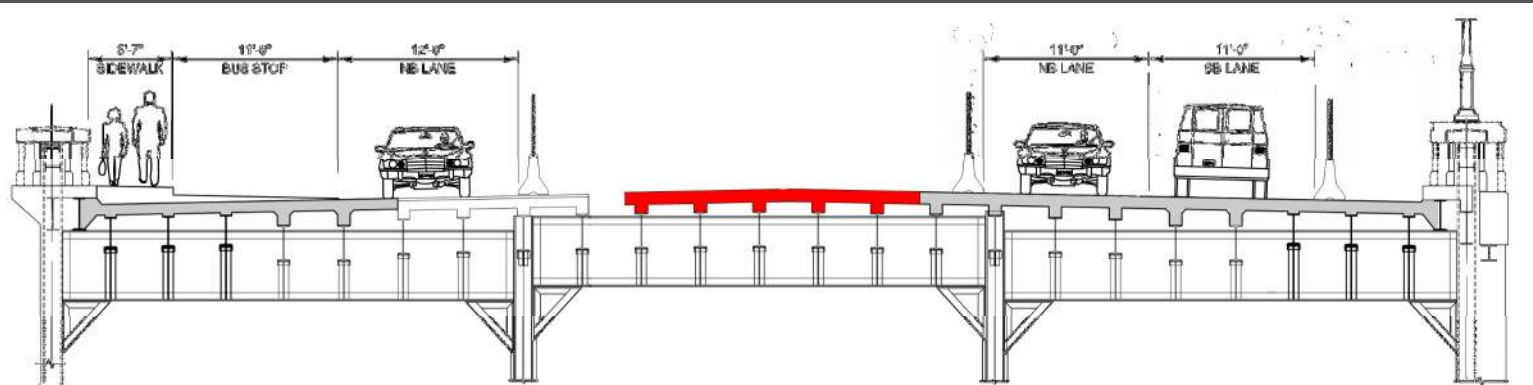

STAGE 2B CONSTRUCTION LOOKING SOUTH - TYPICAL AT BENT STRUCTURE - NYPD AND NYCDOT GARAGE AREAS

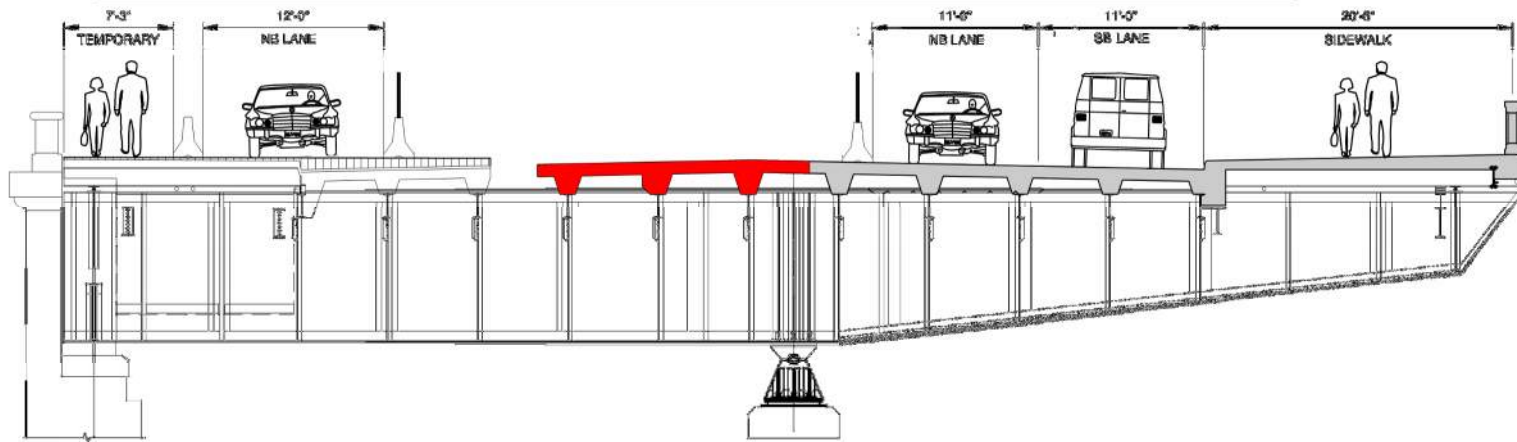

STAGE 2B CONSTRUCTION LOOKING SOUTH - TYPICAL AT CANTILEVER STRUCTURE - AMTRAK AREA

Work Zone Control Stage 3

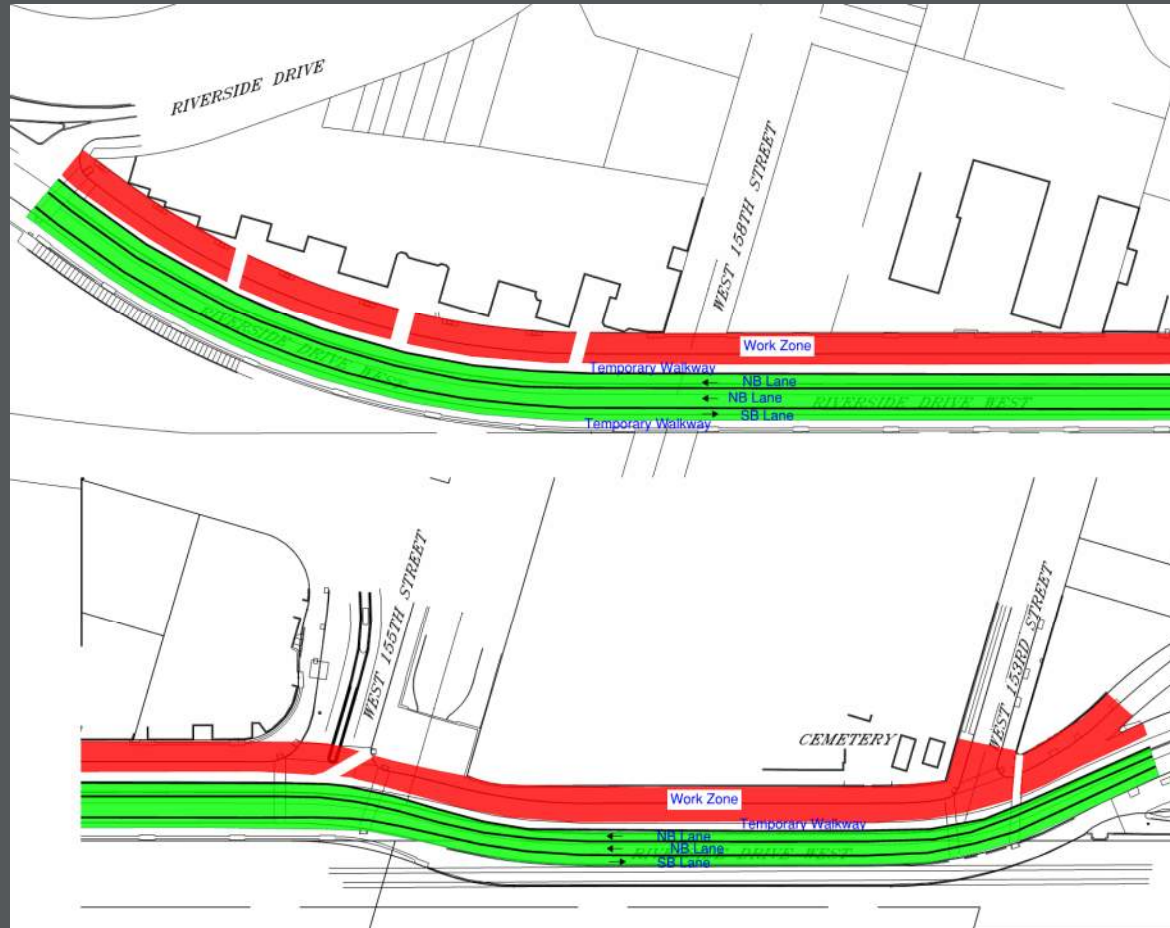

Work Zone Control Stage 3

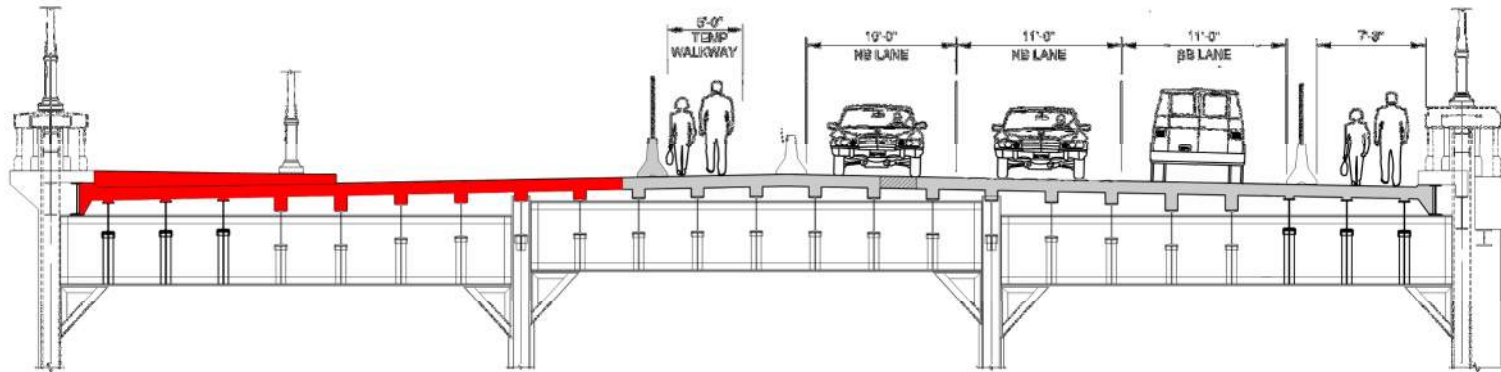

STAGE 3 CONSTRUCTION LOOKING SOUTH - TYPICAL AT BENT STRUCTURE - NYPD AND NYCDOT GARAGE AREAS

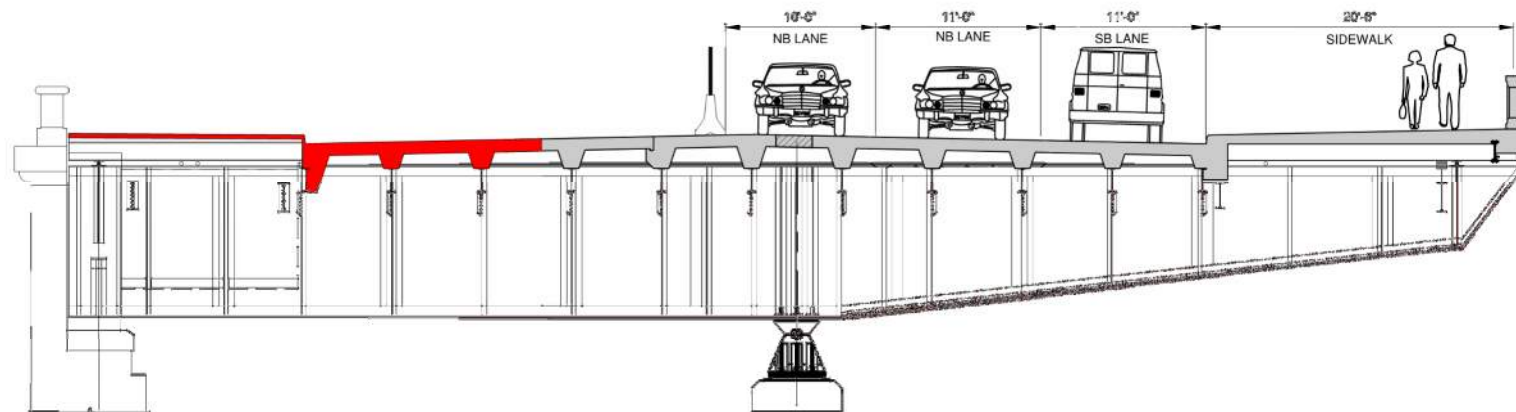

STAGE 3 CONSTRUCTION LOOKING SOUTH - TYPICAL AT CANTILEVER STRUCTURE - AMTRAK AREA

Work Zone Control Stage 4



East Sidewalk Staged Reconstruction Buildings Access During Construction WZTC Stage 3A-1

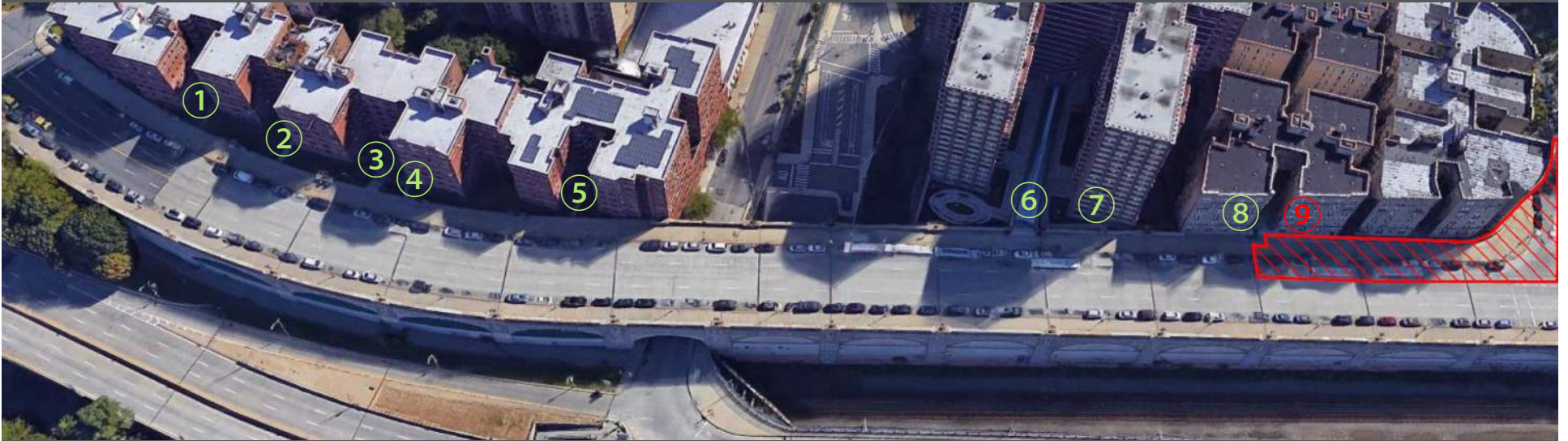

East Sidewalk Staged Reconstruction Buildings Access During Construction WZTC Stage 3A-2



East Sidewalk Staged Reconstruction Buildings Access During Construction WZTC Stage 3A-3



East Sidewalk Staged Reconstruction Buildings Access During Construction WZTC Stage 3A-4



East Sidewalk Staged Reconstruction Buildings Access During Construction WZTC Stage 3A-5





Questions?

NYCDOT
Contract No.
HBM1165
BIN 2-24672-0

**Town Hall Meeting
February 25, 2019**



Public Transportation



Bx6 Bus Route Through Project Site & Terminus Stop on Riverside Drive West at W158th Street

Bx6 Bus Stops & Fare Machines



Before and After Construction

- SBS / Local Bus Stop and SBS Fare Machines at Riverside Drive West over W158th Street



Bx6 Bus Stops & Fare Machines



During Construction

- SBS Stop and Fare Machine at North Corner of Project Site (Riverside Drive)
- Local Bus Stop on Riverside Drive West over W158th Street over W158th Street

